

**GETTING ACQUAINTED WITH  
RECEIVER SERVICING**

4FR-3

**NATIONAL RADIO INSTITUTE**

ESTABLISHED 1914

**WASHINGTON, D. C.**



# GETTING ACQUAINTED WITH RECEIVER SERVICING

## We Study a Modern Radio Receiver

**I**F RADIO servicing is to be your chosen work, you will unquestionably deal with radio receivers most of the time. And no matter what other branch of radio you intend to get into, you will still work with receivers part of the time.

*For example*, in practically every broadcast station there is at least one radio receiver. This receiver is tuned to the station frequency, and enables the radio operator on duty to hear exactly what the thousands of radio listeners are hearing. A radio operator at a huge transmitter would certainly feel embarrassed if he had to call in a

radio serviceman to fix his own monitor receiver when trouble developed.

The two-way radio communication stations used on boats, airplanes, and other mobile equipment provide more examples. Failure of just one tiny part in the radio receiver can put one of these stations out of action just as effectively as failure of the largest part in the station's transmitter.

The fundamental principles *which make a radio receiver work* also apply to transmitters, test instruments, and all other radio apparatus. Yes, radio receiver parts and circuits work exactly like the corresponding parts and



Photo by F. C. Wilkinson

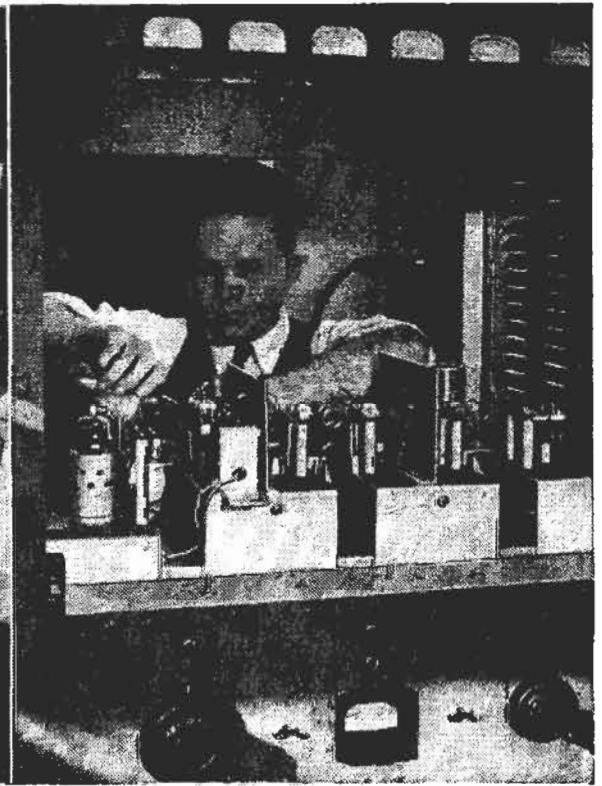

Courtesy General Electric Co.

**Radio men use receiver servicing techniques for all types of radio equipment. Thus, the method which the man at the left is using to repair a modern all-wave superheterodyne receiver will apply equally well to the television transmitter being serviced by the man at the right.**

circuits you find in all other types of radio equipment, wherever you may be—in the radio room of an ocean liner, at the radio controls in a transport air liner, at the sending key of a forest fire lookout station, in the control booth of the public address system at a huge football stadium, or in any of the broadcast and short-wave radio stations throughout the world.

Once you learn how to repair radio receivers by using modern professional servicing techniques, you will have the foundation training for operating and repairing practically any other piece of radio apparatus.

### Preview of This Lesson

In this Lesson, you imagine that you have in front of you the table model receiver pictured in Fig. 1. It is an average modern receiver, using the latest *superheterodyne* circuit (pronounced *SOO-pur-HET-ur-o-DINE*, and often abbreviated as *superhet* or *super*). With the aid of special illustrations, you learn about the parts in this receiver and their general purposes, just as if the set were right in front of you in your own home.

Starting with the front of the receiver, you learn what each control knob does and how it is used. The meanings of the printed numbers and scales on the receiver tuning dial are clearly explained. You find out what to do when a customer loses one or more of the front-panel knobs or controls.

You remove the “works” (the *chassis*, pronounced *CHASS-iss*) from the receiver cabinet, then examine in turn each of the parts on top of the chassis, including the radio tubes, the loudspeaker, the output transformer, the gang tuning condenser, and some new parts which you take up for the first time here. In the same way, you study



FIG. 1. This modern superheterodyne receiver is used as an example throughout this Lesson.

the many smaller parts which are located underneath the chassis.

Throughout this Lesson, the practical viewpoint is stressed. You learn a great deal about how a part is made, what it does, how it can fail or give trouble, and how it is repaired or replaced.

### Radio Map of a Superhet

Your study of this Lesson will be much easier if you first get a general idea of what a superheterodyne circuit is. You are already familiar with the other common type of receiver circuit—the t.r.f. circuit, so it will be particularly interesting to find out why the superheterodyne can “run circles” around a t.r.f. receiver of the same size.

Figure 2 is the “radio map” which gives you the facts about the circuit arrangement of the superheterodyne receiver used as the example for this Lesson. As you can see, the first stage in our receiver is the *MIXER-FIRST DETECTOR*. It receives two signals:

1. *The desired modulated r.f. carrier signal*, which is produced in the receiving antenna by radio waves.

2. The r.f. signal, which is self-generated in the *R.F. OSCILLATOR* stage in such a way that its frequency is exactly 456 kc. higher than the carrier frequency of the desired incoming signal.

Now comes the action which makes the superhet so different from a t.r.f. receiver. The mixer-first detector combines its two incoming signals to give an entirely new signal called the *i.f. signal*.

The new modulated i.f. carrier sig-

After the carrier frequency of the desired incoming signal has been changed to 456 kc. by the mixer-first detector, the resulting i.f. signal is fed into the *I.F. AMPLIFIER*. There it receives a tremendous amount of amplification, because an i.f. amplifier stage which works at *only one* carrier frequency is many times more effective than an amplifier stage which must work at many different frequencies. (In a t.r.f. receiver, you know, the r.f. amplifier stages must handle any car-

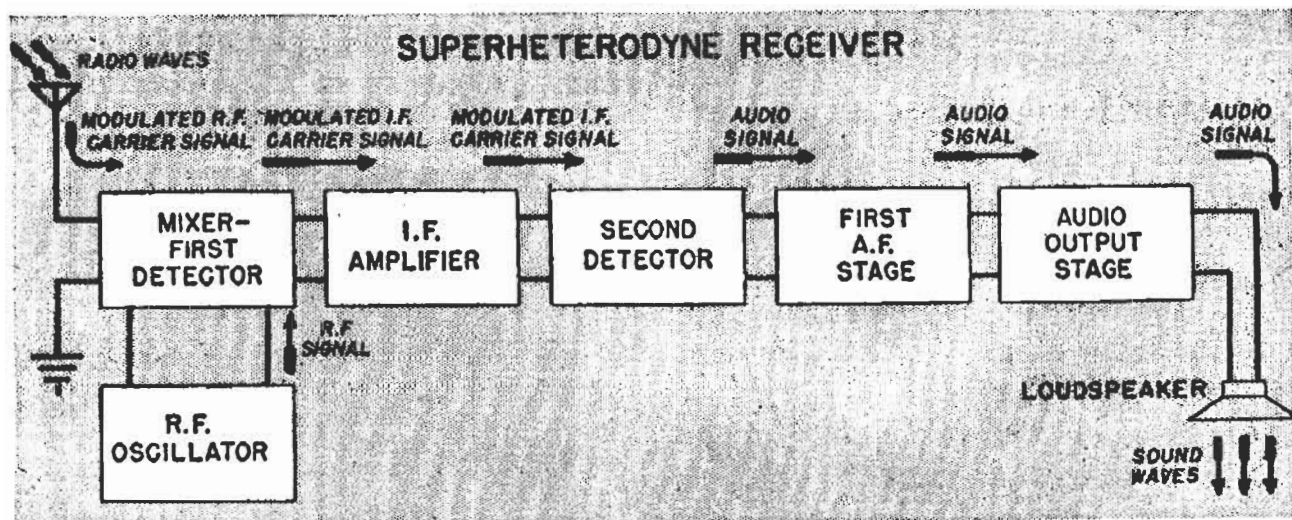

FIG. 2. Arrangement of stages in the superheterodyne receiver used as an example in this Lesson.

nal in this receiver (and in many other superheterodyne receivers) *always* has a carrier frequency of exactly 456 kc. (This value is the difference between the frequencies of the r.f. signal and the incoming carrier signal.)

Strictly speaking, we should call this new signal the *modulated intermediate frequency carrier signal*, because it still has the original audio signal modulation. Since you are going to work with radio men, however, you will undoubtedly want to talk their own language, and say "eye ef signal" just as they do.

The frequency of the i.f. carrier signal is *in between* the r.f. carrier frequency and audio frequencies. This is why the new signal is called an *intermediate frequency signal*.

rier frequency which the listener tunes in.)

The strengthened i.f. signal enters the *SECOND DETECTOR*. This stage separates the audio signal from the i.f. carrier signal, and also gets rid of the i.f. carrier since it is no longer needed. The second detector thus gives us the audio signal we have been working for all this time.

The audio amplifier and loudspeaker, following the second detector of this super, are exactly like the audio amplifier and loudspeaker of a t.r.f. receiver. Thus, the audio signal gets one boost in strength from the *FIRST A.F. STAGE*, and gets another boost from the *AUDIO OUTPUT STAGE* before being fed to the *LOUDSPEAKER*. Here the audio signal

is changed into *SOUND WAVES* which are the desired radio program.

### You See How Radio Men Work.

After becoming thoroughly acquainted with the various parts in this receiver, you will see how radio servicemen go about locating and repairing trouble in the receiver.

Once the trouble is located, the defective part is easily replaced or repaired. It is in finding the cause of the trouble that a complete knowledge of the purposes and actions of radio parts counts.

### Front-Panel Parts

**Control Knobs.** The general arrangement of the controls on this receiver is typical of that used in most modern receivers, and is shown in Fig. 3.

To turn on this set you turn the *volume control* knob clockwise until a click is heard. This turns on the power pack, by completing the circuit for the power cord which goes to a wall outlet.

Further clockwise rotation of this knob increases the volume of loudness of the program coming from the loud-speaker.

When you tune in a station with the *tuning control* knob, you are doing two things: 1. Rotating the gang tuning condenser to the correct setting for reception of the station; 2. Moving a pointer to the position on the tuning dial at which the frequency of the station is indicated.

The *tone control* knob allows you to change the tone of the sound coming from this receiver, by reducing the strength of higher audio frequencies. The lower audio frequencies will then predominate, and give a mellow bass tone which emphasizes drums, large bass horns, and men's voices.

On some receivers, it is also possible to set the tone control to reduce the strength of only the *lower* audio fre-

quencies. The high frequencies of violins, cornets, bells, and women's voices will then be emphasized. Tone controls are provided because people's tastes differ regarding tone just as much as tastes differ regarding food, clothes, or almost anything else.

**Tuning Dial.** It is common practice among receiver manufacturers to mark the tuning dial in kilocycles, with the last zero in the frequency value omitted. The dial shown in Fig. 3 is an example of this practice. If you add a zero to each number printed on this dial, the numbers represent *frequency in kilocycles*.

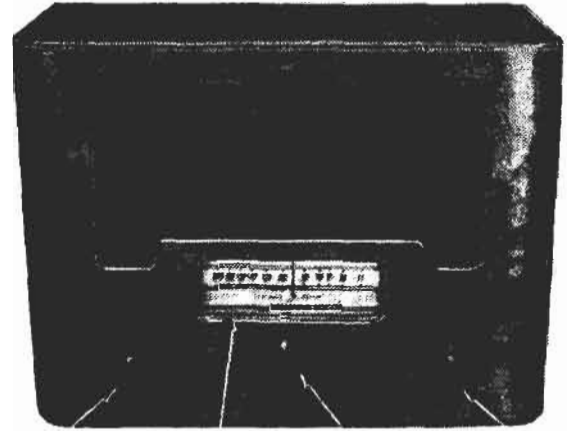

ON-OFF AND TUNING TUNING TONE  
VOLUME DIAL CONTROL CONTROL  
CONTROL

FIG. 3. Front view of the modern superheterodyne receiver used as an example throughout this Lesson.

Radio station frequencies are usually expressed in kilocycles for convenience, so the term *kilocycle* (abbreviated *kc.*) is one which you should remember. (One kilocycle is equal to 1000 cycles.)

The tuning dial shown in Fig. 3 extends from 550 kilocycles to 2000 kilocycles, hence our superhet receiver covers the entire *broadcast band* and certain police bands just above the broadcast band.

**Replacing Control Knobs.** When a Radiotrician encounters a receiver having a broken or missing control

and pull on the ends of the handkerchief.

**Removing Chassis Screws.** Next, we use a medium-size screwdriver to loosen the two wood screws which fasten the chassis base to the bottom of the receiver cabinet, as illustrated in Fig. 5.

In some receivers, the chassis is fastened with bolts which pass through the bottom of the cabinet. These are removed with either a screwdriver or a socket wrench, depending upon the type of bolt head employed, after turning the receiver on its side so

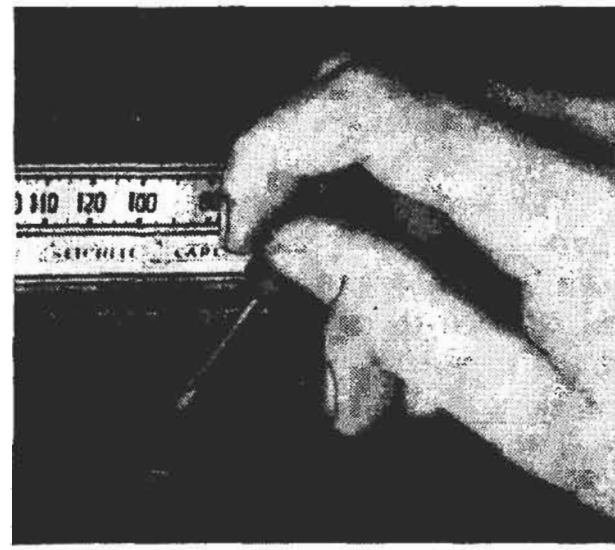

**FIG. 4.** Loosening the set screw of a receiver control knob with a small screwdriver. Some knobs may have two set screws.

knob, he will first try to obtain a new knob exactly like those already on the set.

If an exact replacement knob is not available, he will secure an entire set of new knobs, having a design and color which will harmonize with the finish of the receiver cabinet.

### Removing the Chassis

In order to get a good look at the radio parts in our receiver, we will have to remove the *chassis* from the cabinet. The chassis includes the metal *chassis base* and all parts mounted on this base.

**Removing Control Knobs.** We first loosen the tiny set screw in each control knob, using a small screwdriver as illustrated in Fig. 4, then remove the knobs.

Sometimes knobs are held in position by stiff flat springs inside the knobs, instead of screws. These knobs are removed by pulling firmly. If it is difficult to get a good grip on a small knob, slip a handkerchief between the knob and the cabinet,

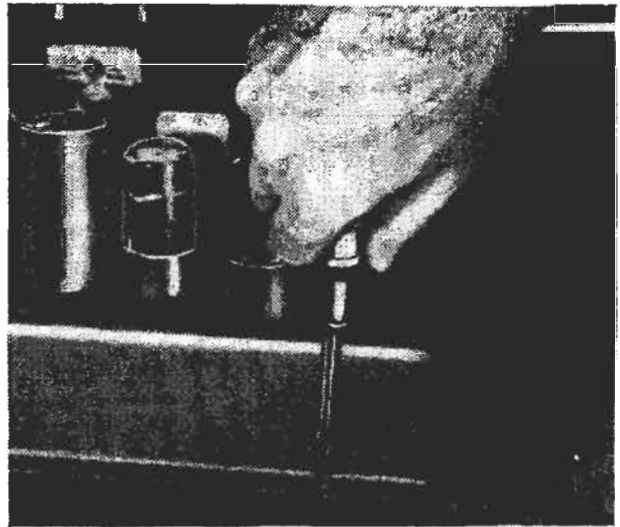

**FIG. 5.** Using a medium-sized screwdriver to remove the chassis hold-down screws at the back of our superheterodyne receiver.

that the bottom of the cabinet is accessible.

The chassis-removing procedure just described applies to practically any radio receiver, so let's repeat it here as a practical radio servicing rule: *To remove the chassis from the cabinet of a radio receiver, first take off the control knobs, then remove the chassis hold-down screws or bolts.* If the chassis will not come out yet, look for additional hold-down screws around the dial and loudspeaker.

# Radio Receiver Tubes

Now we can slide the chassis out from the back of its cabinet. When this is done, all of the parts on top of the chassis base are clearly visible, as shown in Fig. 6. Study this view for a few minutes, to become familiar with the positions of the tubes and the labeled large parts.

Before you can understand how parts work together in radio circuits, and before you try to locate defective parts, you should have a general idea of how these radio parts look, how they are built, and how they act on signals and circuit currents when operating properly. Therefore, we con-

centrate upon radio parts in this Lesson, starting with tubes.

The five tubes in our superheterodyne radio receiver are all on top of the chassis base, and are easily recognized even though one of them is almost completely enclosed in a metal shield.

**Tube Shields.** First of all, we'll take off that metal shield and see what the hidden tube looks like. We remove the clip from the top cap of the tube, then pull the shield straight up with one hand as shown in Fig. 7.

Yes, there's just an ordinary radio tube inside this shield, a type 6K7

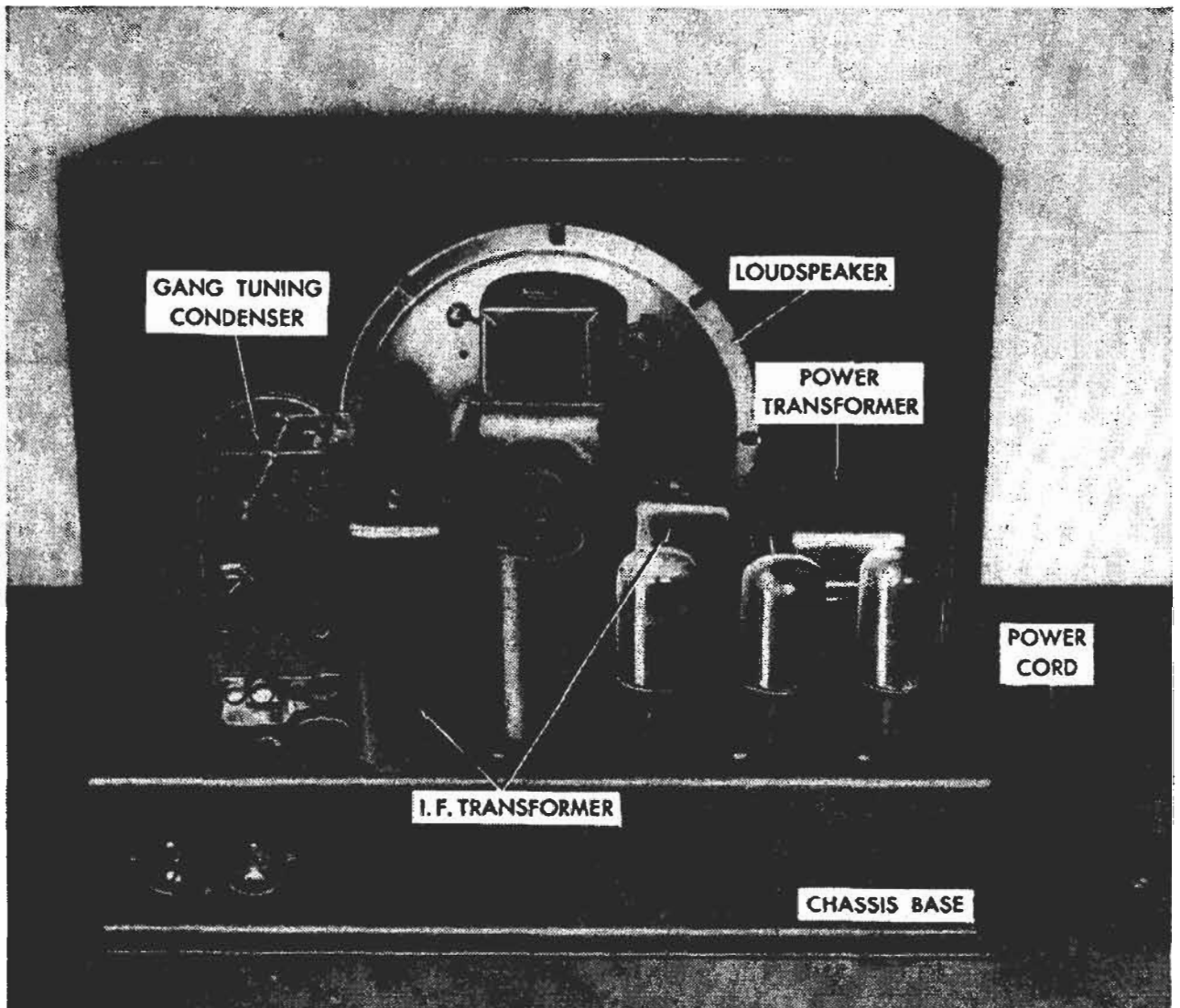

FIG. 6. Rear view of our superheterodyne receiver, with the chassis almost out of the cabinet.

tube serving in the i.f. amplifier stage. It's an important tube, for it receives extremely weak desired signals and boosts them a tremendous amount. But undesired signals would get this same amplification if they got into this tube circuit, so we must use the metal *shield* to protect the tube electrodes from stray fields (stray radiated signals) of other parts. Without a shield, the set would probably squeal at each station as you tuned across the dial.

**Tube Bases.** The tubes in this receiver all have *octal* bases, which means that each one can have as many as eight prongs. Some of the tubes require all eight prongs for connecting purposes, either because the tubes have extra grids or because two or more sets of electrodes are combined in one tube.

When a tube requires less than eight connections to its socket, some of the prongs are omitted during manufacture without changing the positions of the others. Thus, the 6X5 rectifier tube taken from our set and shown in Fig. 8 has only six prongs.

**Tube Numbers.** Each of the tubes in our receiver has an identifying num-

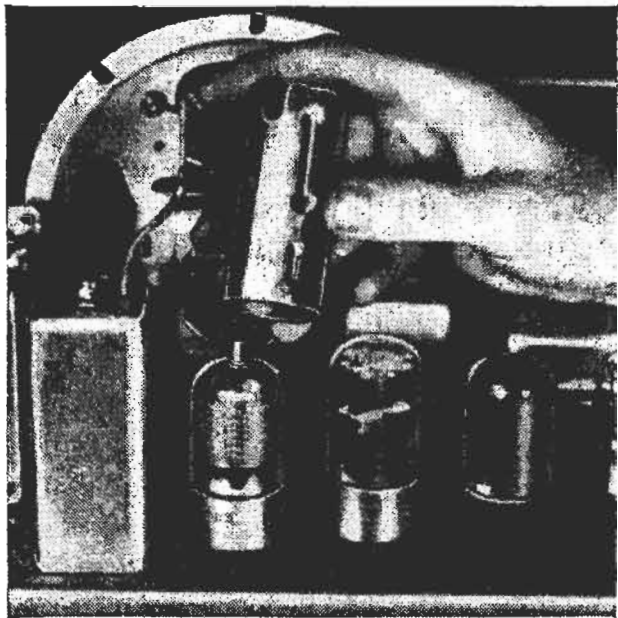

FIG. 7. Removing the shield from a tube.



FIG. 8. This is what you see when you remove a 6X5 tube from a receiver and look at its base.

ber of its own, printed right on the glass envelope or on the base of the tube. Furthermore, each tube is intended for a particular socket on the chassis base of this receiver. Since an octal-base tube will fit in any octal-base socket, the sockets must be identified in some way so as to make sure that the correct tube will be placed in each socket.

**Socket Markings.** The number of the tube intended for each socket has been clearly printed on the chassis base of our receiver, as indicated in Fig. 9.

Sometimes tube sockets themselves are marked. More often, however, there are no markings anywhere near the sockets. Instead, there is a diagram attached to the chassis or the inside of the cabinet, showing which tube goes in each socket.

In a few sets, there will be no markings at all. You can either mark all the sockets yourself before taking out the tubes, or take out only one tube at a time for testing.

**Removing Tubes.** To remove a tube for testing or replacement, pull



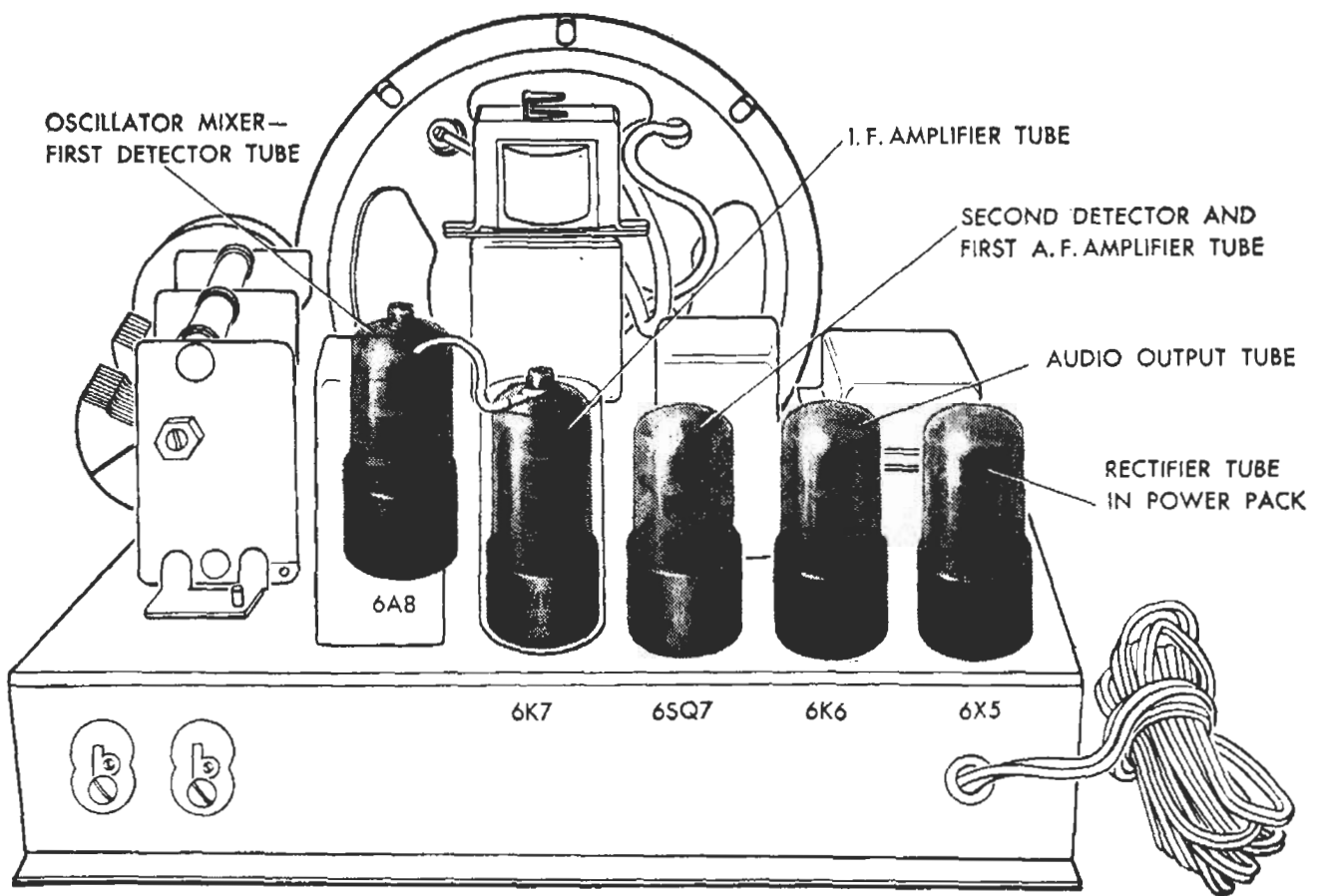

FIG. 9. This is the back of our superheterodyne receiver chassis showing the tubes.

it straight up while wiggling it slightly from side to side. Tube sockets are purposely made to grip tube prongs tightly, so as to provide good electrical contact and prevent tubes from bouncing out during shipment of a receiver. Thus, it may take quite a bit of force to pull out a tube.

Here is a practical tip which may prove very useful when you are trying to remove a tube from a crowded corner of a radio chassis. While pulling and wiggling the tube with your right hand, insert a screwdriver under the tube base with your left hand and twist the screwdriver so as to pry up the tube. Of course, the receiver must be turned off when this is done, for otherwise the screwdriver might short some power supply circuit and cause damage.

**Tubes Get Hot.** All radio tubes heat up when in operation, but some types of tubes get much hotter than others.

The tubes used in battery and portable receivers stay the coolest. All-metal tubes, on the other hand, sometimes get so hot in normal use that you can actually burn your fingers on them.

The tubes in our superheterodyne receiver all use glass envelopes, which in some cases get almost as hot as metal envelopes. Allow a minute or so for the tubes to cool before attempting to remove them, or use a handkerchief or piece of cloth to protect your hand when removing hot tubes.

This precaution applies particularly to the audio output tube and the rectifier tube in a receiver, for these two tubes usually get the hottest. The reason is that the audio output tube has a higher plate current than any other tube except the rectifier tube. As a matter of fact, the rectifier tube handles all the plate and grid currents drawn by all the other tubes in the receiver.

**Testing Tubes.** When a receiver

comes into a radio service shop for repair, tubes are usually the first things which the serviceman checks. He removes the tubes from the chassis and tests them, one at a time, in a special tube-testing instrument like that shown in Fig. 10.

For each tube, he first adjusts the tester controls according to a tube chart furnished with the tester, then plugs the tube into a socket on the tester. If the meter in the tester indicates BAD, the tube is defective.

Although tube testers have a number of different sockets and controls, they are really quite simple to use once the operating instructions are carefully studied. There is no need

the hottest. The intense heat eventually causes the filament wire to melt and break open at a thin spot, causing complete failure of the tube.

When the meter pointer in the tube tester does not move at all from its position at the lowest end of the BAD region, the serviceman knows the tube has a *burned-out filament*.

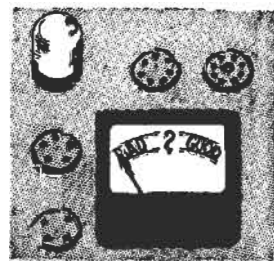

*Low Emission.* Another common cause of radio tube failure is aging of the chemical coating on the **cathode**. This chemical coating gives off electrons when heated by the filament. As the coating wears off during use, fewer and fewer electrons are given off, and the total electron flow from cathode to plate through the tube is correspondingly reduced.

Eventually, the number of electrons given off or emitted is so much reduced that the tube can no longer do its full job in the receiver. Radio men then say that the tube has *low emission*. A tube tester would indicate that the tube was BAD.

When a serviceman encounters a tube which has low emission, he discards it and puts in a new tube.

*Shorted Electrodes.* Another type of radio tube failure is *shorted electrodes* inside a tube. Changes in temperature may cause an electrode to sag out of position enough so that it touches a nearby electrode inside the tube. We then say that the tube has shorted electrodes. Thus, the filament may touch the surrounding cathode and cause a *short*.

Practically all tube testers have a separate red light on the panel of the instrument. This red light glows whenever any two of the electrodes are shorted together. When this light

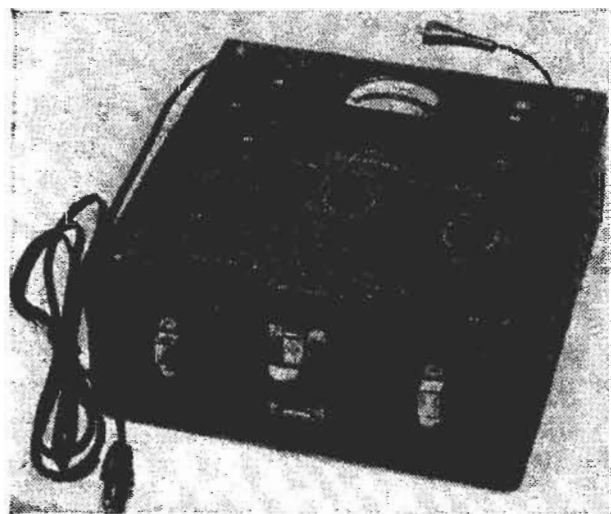

FIG. 10. Radio men use tube testers like this to test tubes.

for you to secure a tube tester yet, however—in fact, you will not need one until you are doing a considerable volume of radio service work.

**How Tubes Fail.** How do radio tubes go bad? Three common reasons are a burned-out filament, low emission, and shorted electrodes.

*Burned-Out Filament.* The filament in a radio tube is normally operated at red heat or even brighter. The thinnest parts of the filament wire get

glows, the radio man knows that he will have to replace the tube anyway, so he ordinarily does not bother to figure out which electrodes are touching.

**More About Tubes.** You will learn a lot more about radio tubes and their electrodes later in the course in a Lesson devoted entirely to radio tubes.

---

## Above-Chassis Parts

Although other superheterodyne radio receivers may look quite different from the average receiver chosen for our example in this Lesson, all superheterodyne receivers use the same fundamental principles of operation and similar groups of ordinary radio parts. Corresponding parts in superheterodyne receivers may look different, but their important purposes and actions will be quite similar.

### The Loudspeaker

Let us consider the loudspeaker next, for it is the largest radio part in our receiver, and has the actual job of changing the final strong audio signal into the sound waves of a radio program.

**Electrodynamic Loudspeaker.** As you previously learned, a modern dynamic loudspeaker has only three important parts: A diaphragm or cone, a *voice coil*, and a *magnet*.

In the loudspeaker used in our superheterodyne receiver, an electromagnet provides the magnetic field, and consequently the loudspeaker is known as an *electrodynamic loudspeaker*. The coil of the electromagnet is called the *field coil*.

The direct current required by the field coil is obtained from the power pack of the receiver. An electrodynamic loudspeaker will therefore have two extra wires, going from the field coil to the proper power pack terminals underneath the chassis. The

field coil and its leads can be seen in Fig. 11, which shows the loudspeaker all by itself on the chassis of our receiver.

Through its connection to the power pack, the field coil also does an important filtering job, about which you will learn more later when you study power packs.

**How It Works.** When an audio signal current is sent through the *voice coil* of our electrodynamic loudspeaker, this voice coil produces a varying magnetic field which reacts with the constant magnetic field of the field coil.

The two coils thus alternately attract and repel each other. The field coil electromagnet cannot move because it is attached to the frame, so only the voice coil moves back and forth. Since the voice coil is attached

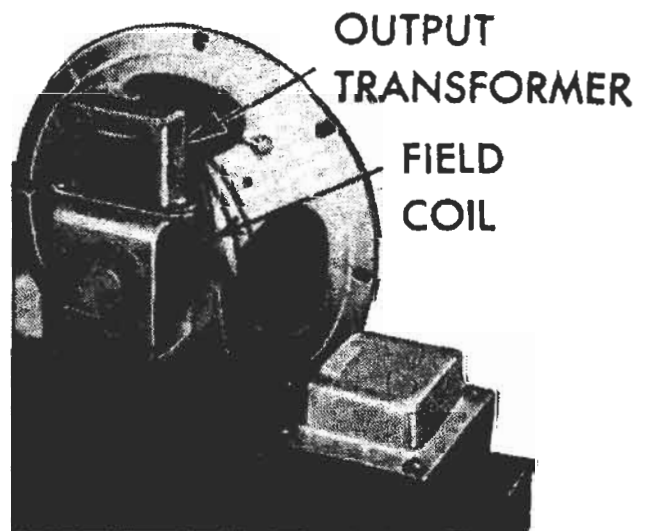
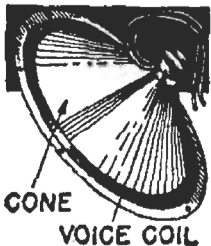

FIG. 11. Here's a close-up view of the loudspeaker in our superhet receiver.

to the cone, the cone likewise moves the surrounding air back and forth, producing the sound waves of radio programs.

**Damaged Cone.** When the stiff paper cone of a loudspeaker is accidentally torn, or when it becomes warped or cracked due to aging, radio programs no longer will sound natural, and will sometimes be accompanied by buzzing or scratchy sounds.

When a Radiotrician encounters a damaged cone, he either replaces the entire cone-voice coil assembly with an exact duplicate replacement assembly obtained from the set manufacturer or a radio parts distributor, or installs an entirely new loudspeaker. Curiously, with small loudspeakers it is often cheaper and more satisfactory to put in a new loudspeaker than to replace or repair a damaged cone.



**Off-Center Voice Coil.** One common loudspeaker trouble is an off-center voice coil. This coil moves in and out in a very small air gap between the pole pieces. Slight warping of the cone or slight shifting of the various parts of the loudspeaker throw the coil off center in the air gap, and the coil then rubs against the pole pieces.

When the voice coil is off center, radio programs will sound distorted on the loud bass notes which are present when a man talks or sings, but will probably be perfectly clear for women's voices, which have few low notes. You may hear a rubbing sound when you push the cone in and out with your fingers after the set is turned off.

When the voice coil is properly centered, you should be able to move it in or out without having the coil

rub against the pole pieces between which it moves.

Practically all of the older loudspeakers and even a great many modern loudspeakers have provisions for recentering the voice coil. These loudspeakers will either have one screw inside the voice coil or several screws arranged around the outside of the voice coil. When these screws are loosened, the voice coil can be moved a small distance sidewise in any direction for recentering purposes.

With the screws loose, small narrow strips of celluloid or cardboard are inserted between the inside of the voice coil and the central iron core of the loudspeaker to provide automatic centering. The screws are then tightened, after which the centering strips can be removed.

There is a growing trend toward permanent fastening of the voice coil to the loudspeaker frame. The loudspeaker used in our superheterodyne receiver is an example of this, and its voice coil cannot economically be recentered by the radio serviceman. If for any reason the voice coil gets off center, the loudspeaker can be returned to a loudspeaker cone manufacturer or a radio supply firm for installation of a new cone-voice coil unit, or the entire loudspeaker can be replaced.

**Open Field Coil.** A broken wire (usually due to corrosion) is about the only trouble encountered in the field coil of an average electrodynamic loudspeaker. The trouble usually occurs at one end of the coil, at the point where the flexible insulated field coil lead is connected to the enamel-covered coil wire. If the trouble is at the outer end of the coil, it can often be repaired after removing the outer layer of insulating cloth from the coil.

When the field coil opens up and

the break cannot be repaired, it is sometimes possible to remove the defective field coil and install a new one. In many of the smaller modern loudspeakers, however, the core of the field coil is permanently anchored in position during manufacture, making it impossible to remove the field coil. The entire loudspeaker must then be replaced.

**Replacing a Loudspeaker.** After a receiver has been in use for three or four years, the paper used in its cone becomes quite brittle, and this appreciably affects the tone quality of the loudspeaker. The installation of a new cone or a new loudspeaker will usually provide a definite improvement in tone quality, with a corresponding increase in customer satisfaction with your work.

When replacing a loudspeaker with an exact duplicate replacement unit obtained from the receiver manufacturer or a radio supply house, all you need to be careful about is the connections. Make a rough sketch showing the terminals to which the voice coil and field coil leads of the old loudspeaker were connected, and use this as your guide for connecting the leads of the new loudspeaker.

### The Output Transformer

The small radio part mounted on top of the loudspeaker in Fig. 11 is the *output transformer*. Its job, as you know, is to transfer audio signals from the audio output tube of the receiver to the loudspeaker in such a way that the loudspeaker gets the low-voltage, high-current signal it requires for most efficient operation.

**Construction.** The output transformer has two coils of wire, wound one over the other on an iron core. The primary coil contains many turns of fine wire. The secondary has fewer turns but uses heavier wire. The pri-

mary coil is connected to the output of the receiver, while the secondary coil is connected to the voice coil of the loudspeaker.

**Open Coil.** A break in either of the coils of wire in the output transformer will cause failure of a radio receiver. When such a break occurs, the serviceman says that the output transformer is *open*, and replaces the entire transformer. If the old transformer is held in place with rivets, he either drills out the rivets or cuts off their spread-out ends with side-cutting pliers. There are usually only four connections to unsolder, so this is a fairly simple service job. Either rivets or nuts and bolts can be used for mounting the new transformer.

Once the trouble has been isolated to the audio output stage by professional servicing techniques, the output transformer can be checked by two simple ohmmeter measurements, one across each winding.

### The Gang Tuning Condenser

In Fig. 12 is a clear illustration of another highly important large part in our superheterodyne receiver, the *gang tuning condenser*. It has two sections, which work with the two r.f. coils located underneath the chassis. A tuning condenser is never used by itself; it is always used with a coil, and *tunes* the coil to a particular frequency. You will find this interesting situation many, many times in radio—different parts acting together to produce special results which the parts could not give separately.

One gang tuning condenser section is connected to an r.f. coil in the input circuit of the mixer-first detector input, and tunes the r.f. coil to the frequency of the desired incoming signal. The other gang tuning condenser section is connected to the r.f. oscillator coil in the oscillator circuit, and tunes

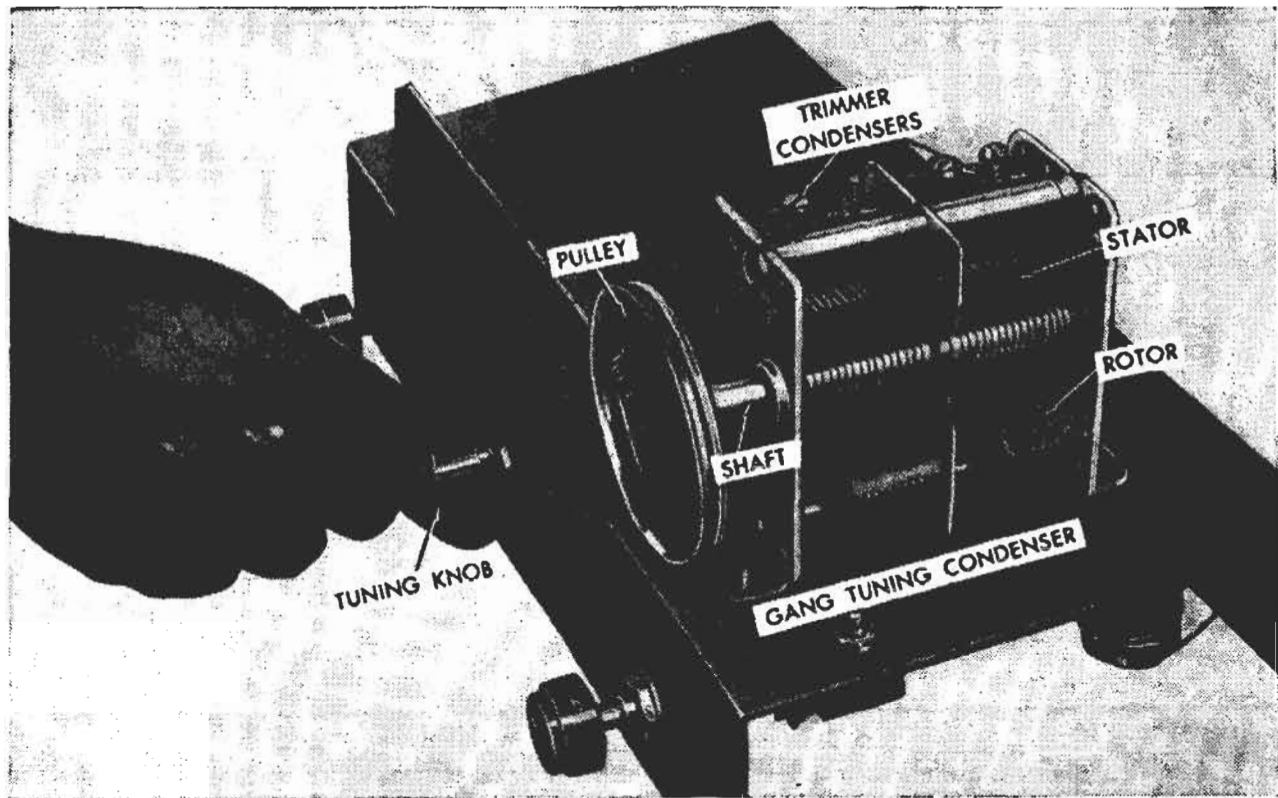

FIG. 12. View of the gang tuning condenser in our superheterodyne receiver, with important parts identified.

this coil to a frequency exactly 456 kc. higher than the desired incoming carrier frequency.

**Rotor and Stator.** Each section of our gang tuning condenser in Fig. 12 has two important parts:

1. A *rotor*, which in this particular unit has eleven aluminum plates. Both rotors are mounted on the same condenser shaft.

2. A *stator*, which consists here of ten aluminum plates mounted on but *insulated* from the condenser frame.

The rotor of each tuning condenser section *rotates*, but the stator of each section is stationary, staying in the same position all the time.

**How the Capacity Varies.** When the shaft of the gang tuning condenser is turned in one direction, the rotor plates go farther in between the stator plates, without ever touching the stator plates. This increases the electrical size or *electrical capacity* of each tuning condenser section.

Turning the shaft in the opposite direction brings the rotor plates out from the stator plates, reducing the electrical capacity of each section.

It is this change in the electrical capacity of each gang tuning condenser section which tunes the receiver to different stations. In later Lessons you will learn exactly how this is done.

**Dial Cord.** The tuning control knob in our superheterodyne receiver is quite some distance from the gang tuning condenser shaft, as you have probably noticed already in Fig. 12. Now, what makes the tuning condenser shaft rotate when we turn the tuning control knob? Also, what makes the dial pointer move to the correct dial number for the station whose program is coming from the loudspeaker?

Figure 13 shows the answer—simply a length of braided dial cord and a few pulleys. The cord runs around a small pulley on the tuning control knob shaft, around a large pulley on the gang

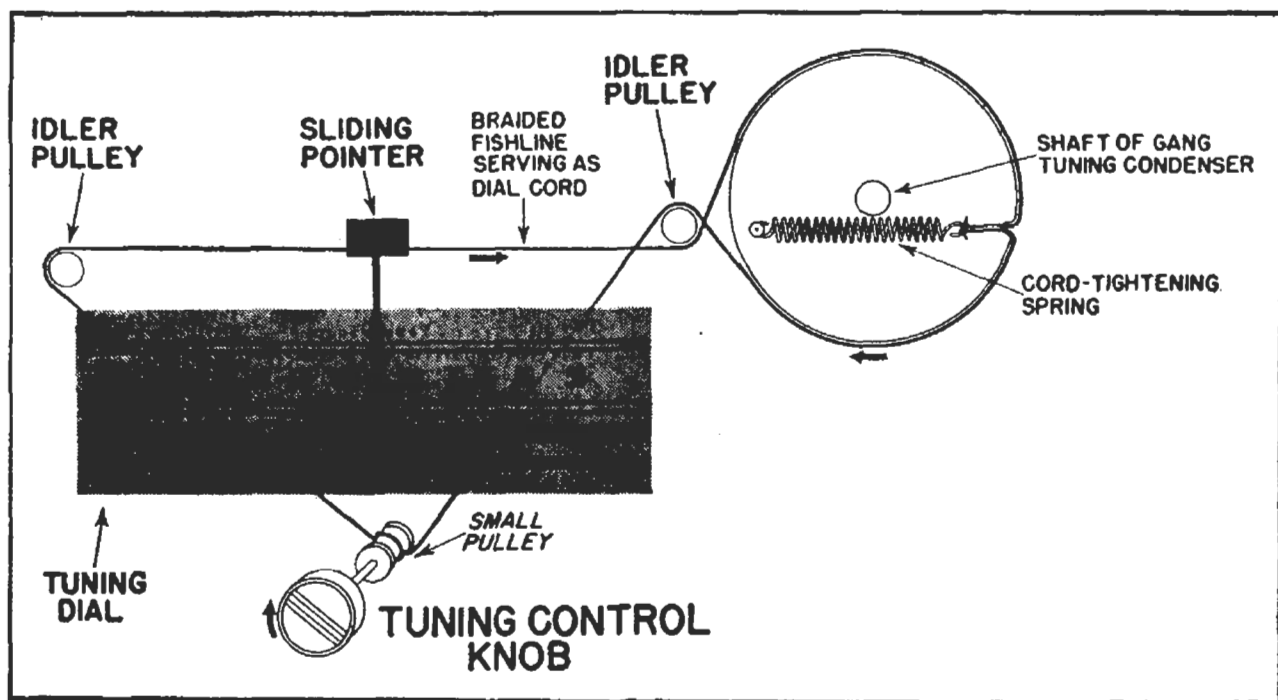

FIG. 13. This diagram shows how a length of fishline is used to make the pointer slide over the tuning dial and make the gang tuning condenser rotate when the tuning knob is turned.

tuning condenser shaft, and around two idler pulleys. A spring inside the large pulley keeps the cord tight.

The pointer is attached to the dial cord at the position shown. When you turn the tuning control knob in a clockwise direction, the sliding pointer moves to the right along the tuning dial, and the gang tuning condenser shaft turns in a clockwise direction.

The average radio set owner never sees this cord-and-pulley system, because it is at the front of the chassis, and cannot be seen when the chassis is in its cabinet. For this reason, a radio serviceman will usually be called even for a mechanical trouble such as a broken dial cord.

**Restringing a Dial Cord.** The diagram in Fig. 13 also gives you the necessary information for restringing the dial cord of our superheterodyne receiver. After removing the old dial cord, tie one end of the new cord to the spring, bring the cord entirely around the system exactly as shown in the diagram, then tie the other end

of the cord to the spring and cut off surplus cord.

Now tune in a local station whose frequency you know, then push the pointer over the cord at the frequency number of this station. There are spring clips behind the pointer for gripping the cord. If restringing is properly done, the pointer will now move to the correct dial number for whatever station you tune in.

**Bent Rotor Plates.** Defects in a gang tuning condenser are generally easy to locate and repair. For instance, one of the rotor plates may become bent so that it touches an adjacent stator plate. This shorts one of the tuning circuits, and the receiver no longer plays. In other cases, the short is only momentary, and causes noise in the loudspeaker as the receiver is tuned.

Sometimes you can hear the condenser plates scraping against each other if you listen closely while turning the tuning control knob. The remedy simply involves straightening

the bent plate with a putty knife or a thin-bladed screwdriver.

### Trimmer Condensers

On top of each section of the gang tuning condenser is a small adjustable device known as a *trimmer condenser*. The purpose of these two trimmer condensers is to take care of any small differences which might exist between the two sections of the gang tuning condenser.

When the two tuning condenser sections are correctly matched by adjusting the "trimmers," both sections will automatically be tuned correctly for reception of a desired station when the tuning dial pointer is at the station frequency.

#### Construction.

Each trimmer condenser consists of one fixed and one movable metal plate, separated by a sheet of *mica*, an insulating material. Tightening the adjusting screw brings the

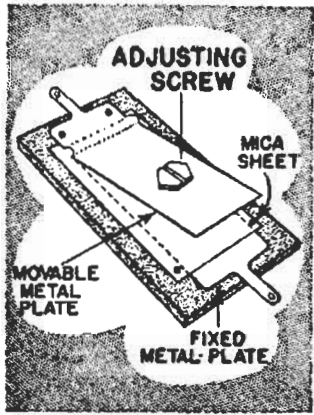

movable plate closer to the fixed plate, and thus increases the electrical size or capacity of the trimmer. Loosening the screw reduces the capacity of the trimmer.

The construction of a trimmer condenser is so simple that this unit rarely becomes defective. Correct adjustment is the chief problem of the radio man when working with the trimmer condensers in a receiver.

**Adjustment.** Although the actual adjustment of a trimmer condenser with a screwdriver or wrench is an extremely simple job, considerable knowledge of radio servicing techniques and radio fundamentals is nec-

essary in order to know when and how much to turn the screwdriver or wrench during the alignment procedure. This is another highly practical technique which you are going to learn in the NRI Course.

### I. F. Transformers

Also on top of the chassis base of our superheterodyne receiver are two parts which look like square metal cans. Through the two holes in the top of each can, we can see adjusting screws if we look carefully. These screws are fairly reliable identifying clues which tell that the parts are *i.f. transformers*. The square cans are simply *shields* which protect the inner coils from the effects of stray electric and magnetic fields. These shields also keep the fields of the coils from affecting other parts.

**Construction.** Figure 14 shows what you would see if you removed a few nuts, then lifted up the square shield of one of the *i.f.* transformers. Inside this shield are two small coils mounted on a wood rod. Above the coils are two trimmer condensers, one connected across each coil. These are the trimmer condensers which you adjust with a screwdriver through the holes in the top of the shield during alignment of the receiver.

**What I.F. Transformers Do.** When the gang tuning condenser and its coils are adjusted or tuned to a desired incoming carrier signal, these parts cannot always keep out undesired signals having different frequencies. *I.F.* transformers are much more selective, however.

The only signal which can get through a properly adjusted *i.f.* transformer without serious reduction in strength is the one whose carrier frequency is the *i.f.* value of the receiver (456 kc. in this case).





**FIG. 14.** This is what you see inside the i. f. transformer when you lift the metal shield can.

The oscillator-mixer-first detector automatically changes the carrier frequency of the desired incoming signal to the i.f. value, but changes undesired signals to other frequencies which can-

not get through. One i.f. transformer transfers the desired signal from the mixer-first detector to the i.f. stage, and the other i.f. transformer transfers the desired signal from the i.f. stage to the second detector.

**Open Coils.** The coils in an i.f. transformer are made from small-size insulated copper wire. This wire sometimes breaks as a result of vibration or jarring, strains set up by changes in temperature, corrosion at soldered joints, or swelling of the coil form in damp weather. Any break in the coil wire interrupts the signal circuit, thereby causing complete failure of the receiver. If the break is at a joint, it can sometimes be repaired by soldering. If not, a new i.f. transformer must be installed.

Sometimes a connection may be weakened by corrosion without being completely open. This defect can cause loud crackling noises in the loudspeaker as the connection opens and closes at irregular intervals.

These are just a few of the many receiver troubles which cannot be seen by examining the parts. A systematic

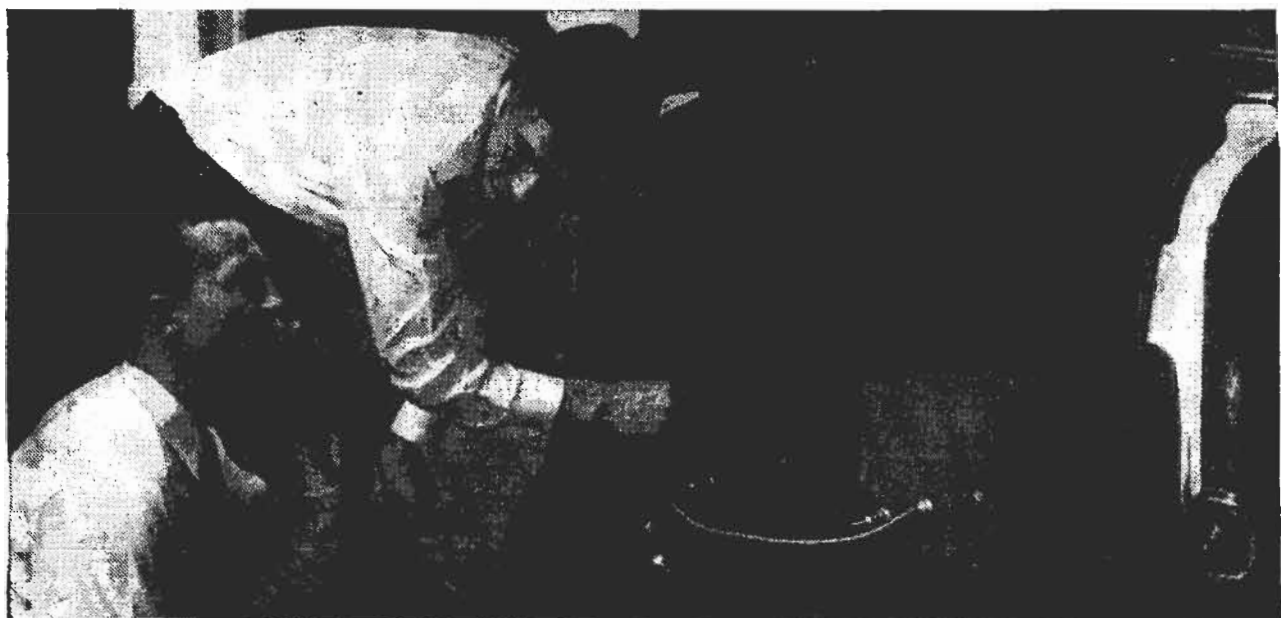

*Courtesy Western Electric Co.*

The radio man at the right is adjusting a trimmer condenser in the transmitter unit of a two-way mobile police radio set while the other man listens to the effect of the adjustment with a headset plugged temporarily into a test jack on the transmitter.

and efficient trouble-locating procedure such as you learn in the NRI Course is absolutely necessary for locating defects like open i.f. transformers.

### Power Transformer

We now have only one device left to consider above the chassis base of our

superheterodyne receiver. This is the *power transformer*, a large and heavy unit located at the right of the loudspeaker when looking at the back of the chassis. Since all of the leads of this radio part are located underneath the chassis, however, let us postpone its study until we turn the chassis base upside down.

---

## Under-Chassis Parts

Turning the chassis of our superheterodyne receiver upside down, as in Fig. 15, we find that most of the actual wiring and practically all of the small radio parts are underneath. As a result, the bottom of the radio chassis may look somewhat complicated to you now.

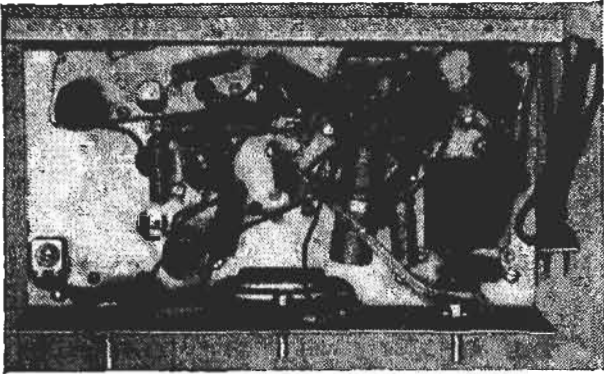

FIG. 15. When you turn the chassis of our superheterodyne receiver upside down for a casual inspection, this is what you see. A radio man doesn't care how complicated a set looks underneath its chassis, however, because he looks only for certain parts or circuits and disregards all the rest.

Don't let this worry you, however. A radio man never has to figure out all at once what every single part under the chassis is doing. When he works underneath the chassis, he is looking for one particular circuit or part, and disregards all the other parts.

In this section, you will see a number of under-chassis views, each with

only certain groups of parts showing. These views really represent what the trained eyes of a radio man might see as he works on the chassis.

### Soldered Joints

Poorly soldered joints between groups of wires or between wires and terminals are a possible cause of receiver failure, but bad joints are just about the easiest defects to repair.

There are over 75 soldered connections which can go bad in our superheterodyne receiver. A loose joint can cause annoying crashing sounds to be heard with the radio program from the loudspeaker when the receiver is jarred, or can momentarily affect receiver performance in other ways.

**Servicing Technique.** Here is how you could go about locating a bad joint. Take the chassis out of the receiver cabinet and set the chassis upside down in such a way that you can see all of the joints under the chassis. Now take a stick of wood and push against each of the joints or leads in turn under the chassis while the receiver is in operation and tuned to a station.

If you hear the crashing sound from the loudspeaker as you move one of the joints or its leads, you know that the joint is loose and should be resoldered. A joint can be loose and

defective even though it looks good, because it takes only a very small separation between wires to cause trouble.

After you learn a bit more about radio fundamentals and servicing techniques, you will become able to tell which section or stage has a defective joint, and will then have to check only the joints in that section.

## Resistors

A careful count reveals that there are nine small carbon resistors mounted underneath the chassis of our super-

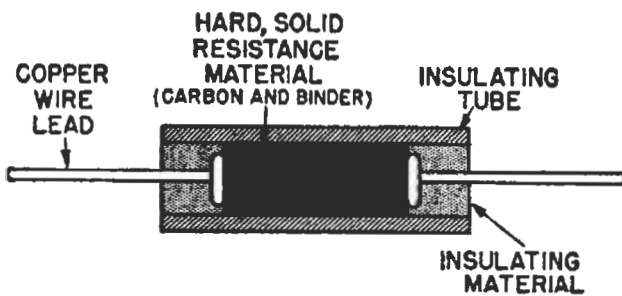

FIG. 16. Inside story of a carbon resistor. The two wire leads (pronounced LEEDS) make contact with the ends of the resistance material.

heterodyne receiver. The construction of one of these resistors is shown in Fig. 16.

Each resistor is in a current-carrying circuit. The current flowing through a resistor produces a voltage drop across it. This voltage drop controls voltage and current in various ways both in the d.c. supply circuits for tubes and in the circuits which transfer signals from tube to tube.

**Resistor Color Code.** Carbon resistors are by far the commonest of all resistors used in radio equipment. Each resistor is marked with rings of color which tell the electrical size in ohms just as accurately as would printed values. Elsewhere in the course, you will be shown how to read the color rings on resistors.

**Resistor Troubles.** A resistor can fail because of a break in one of its

leads, usually inside the resistor or at the point where the wire lead enters the body of the resistor. A crosswise crack in the carbon resistance element can also cause failure of a resistor. In both cases, the radio man says that the resistor is *open*, for the break or crack blocks electron flow through the resistor.

**Locating a Bad Resistor.** A defective resistor can always be located by making tests with servicing instruments, chiefly with an ohmmeter.

**Burned-Out Resistors.** Resistors also become defective due to overheating, which occurs when an excessively large current flows through the resistor.

Overheating may cause the resistor to open up or change its electrical value, but radio men will simply say that the resistor has *burned out*. Such a resistor can usually be spotted at a glance because its colors and markings are blackened by the heat. A blackened resistor is not necessarily defective, however; it may have been overloaded at some time, but not enough to cause failure.

## Condensers

Four different types of condensers are to be found underneath the chassis of our superheterodyne receiver—*paper* condensers, *electrolytic* condensers, *mica* condensers, and *trimmer* condensers. The illustration in Fig. 17 shows all of these condensers.

In basic electrical action, all four types of condensers are alike, in that they all control voltage and current in signal and supply circuits. The chief differences in condensers occur in the method of construction and in the electrical sizes.

**Paper Condensers.** The condenser used more than any other type in radio equipment is the *paper con-*

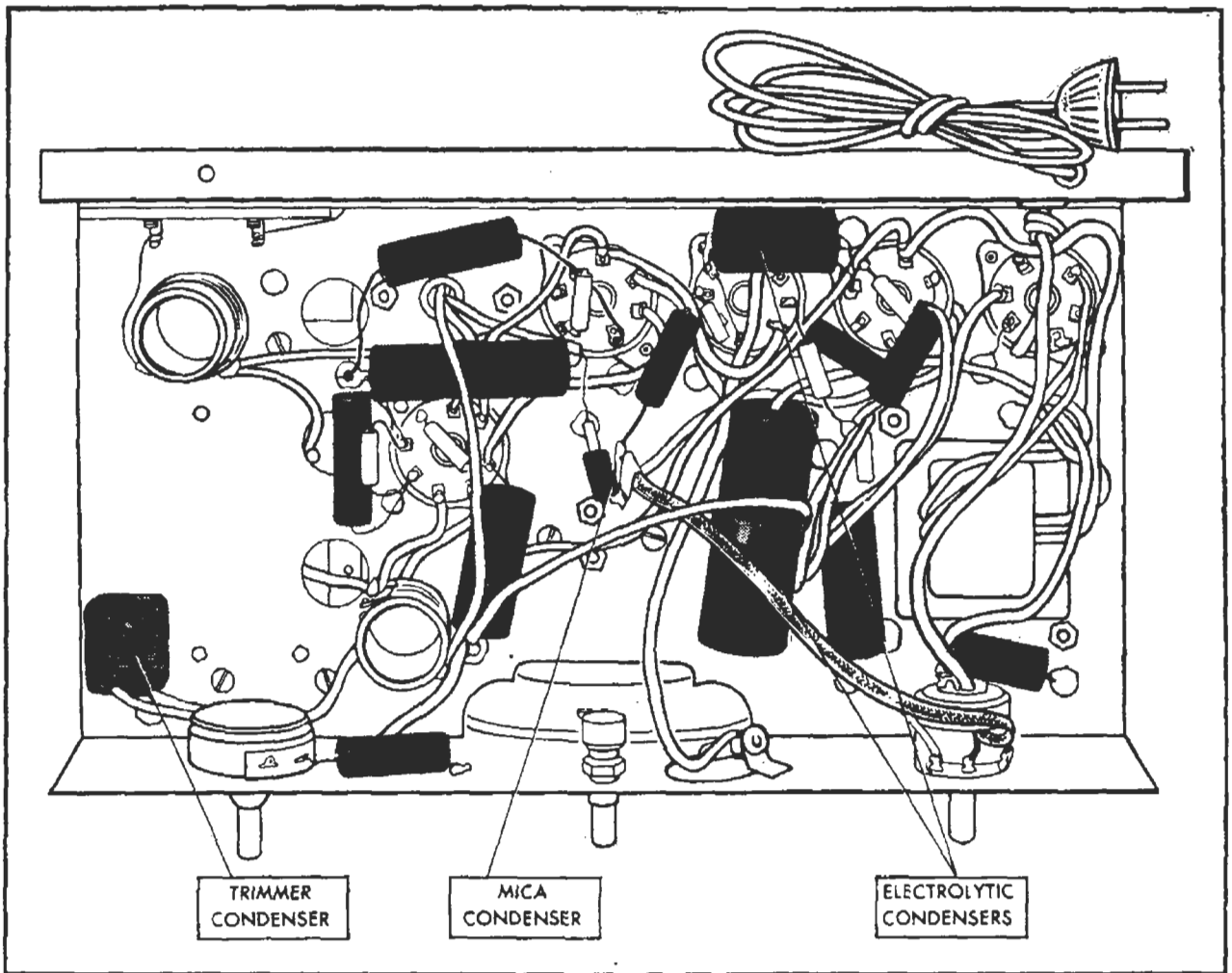

FIG. 17. This shows the condensers underneath the chassis of our superhet receiver. The condensers not marked are paper condensers.

denser. This name comes from the fact that the material used for insulation inside the condenser is waxed paper. The construction is shown in Fig. 18.

*Loose Leads.* A poor connection between a foil strip and one of the wire leads is a common cause of trouble in a paper condenser. A defect of this nature can sometimes be located by wiggling the body of each condenser under the chassis while the receiver is turned on. The defective condenser will usually cause a change in loudspeaker volume when this is done.

*Shorted or Leaky Condensers.* If the waxed paper insulation between the two foil strips of a paper condenser fails completely (becomes

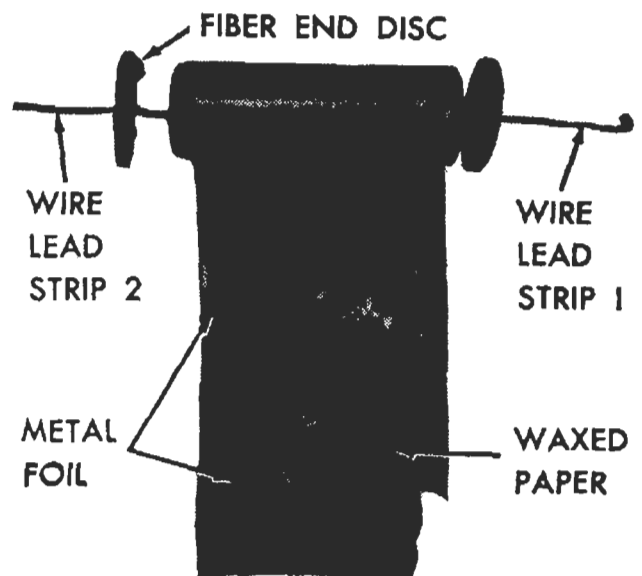

FIG. 18. This photo shows you what's inside a paper condenser. Two long strips of metal foil separated by strips of waxed paper are rolled together, with the two foil strips projecting from opposite ends of the roll and making contact with the two wire leads. The cardboard housing and fiber end discs keep out moisture.

punctured, so that the metal strips touch each other through a small hole in the paper), the condenser is said to be *shorted*.

Just as the high voltage between the points of an auto spark plug can burn a hole through a sheet of paper, so can high voltage burn a hole through the insulation of a paper condenser. This paper insulation weakens with age, so that eventually the normal circuit voltage is sufficient to short the condenser.

If the insulation becomes *partly* defective, so that a few electrons can flow from one strip to the other through the paper, the condenser is said to be *leaky*. Simple measurements with an *ohmmeter* will locate shorted or leaky paper condensers.

*Capacity.* Since one entire Lesson of your NRI Course is devoted to condensers of various types, the manner in which condensers are rated according to electrical size and working voltage need not be taken up in this Lesson. Now we just want to make a general acquaintance with the different kinds of condensers, so let's pass on to the next type.

**Electrolytic Condensers.** Two of the condensers in our receiver are of a special type known as *electrolytic condensers* or simply *electrolytics*. These condensers look much the same as paper condensers, and are made in a similar manner except that there is no paper between the rolled-up aluminum sheets. Instead, the sheets are separated by a moist chemical paste which produces an *insulating film* on the aluminum sheets through *electrolytic* action. (A scientist would explain that electrolytic action occurs when an electric current is sent through chemical materials.)

*Leaky Electrolytics.* Electrolytic condensers are common causes of radio

receiver trouble, for the pasty chemical material spoils with age, reducing the effectiveness of the insulating film. Radio men say that the condenser has then become *leaky*, because the insulating film allows electrons to *leak through* the condenser when they should be held back.

*Connections.* The large electrolytic condenser in this receiver is really two electrolytic condensers combined in one housing. Three insulated leads, colored red, black, and blue respectively, come out of one end of the cardboard housing.

The leads are colored for two reasons, to distinguish between the two sections of the condenser and to indicate the correct polarity of connections. An electrolytic condenser will work as a condenser only when connected in a certain way. Correct connections are designated by calling one lead *positive* and the other *negative*; the positive lead must go to the positive terminal of the circuit. In our large electrolytic condenser, the black wire is the negative lead for both sections of the condenser. The red wire is the positive lead for one condenser section, and the blue wire is the positive lead for the other section. This information is marked on the condenser housing.

It is common practice to combine two or more electrolytic condensers in one housing in this way. A careful radio man always makes a rough sketch of connections before removing an old condenser, to reduce chances for errors when connecting the new unit.

**Mica Condensers.** There is only one *mica condenser* in our receiver. It is a tiny unit encased in molded brown Bakelite, and located just about in the exact center underneath the chassis. (See Fig. 17.) The mica con-

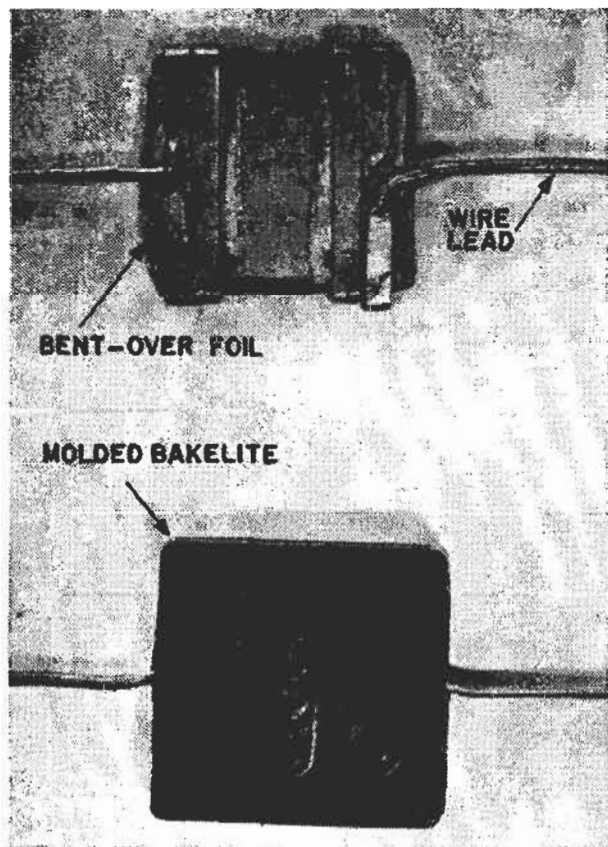
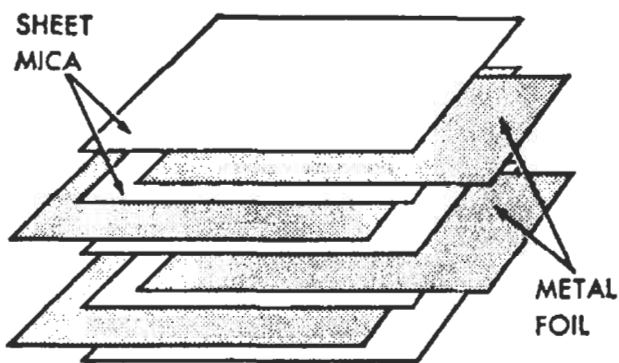

FIG. 19. How a mica condenser is made.

condenser gets its name from the fact that sheet *mica* is used as the insulation between the metal plates. The construction is shown in Fig. 19.

*Possible Troubles.* Mica condensers seldom fail in use, but are more costly than paper condensers. Occasionally a wire lead may break at the point where it enters the Bakelite body of a mica condenser. The break may not always be visible, but can be located by wiggling each of the mica condensers in turn while the receiver is in operation. When a defective condenser is moved in this man-

ner it affects the loudness of the sound coming from the loudspeaker.

The mica insulation can fail because of moisture or excessively high voltages. Adjacent metal plates then touch each other, causing a *shorted* mica condenser. A simple ohmmeter test will reveal this trouble once the defective condenser is located.

**Trimmer Condenser.** As you can see in Fig. 17, there is only one trimmer condenser mounted underneath the chassis. This unit is constructed very much like the trimmer condensers already studied.

Just as with the other trimmer condensers in this receiver, the chief problem is *knowing how* to make the simple screwdriver adjustment which is required during alignment of the receiver.

This particular trimmer condenser is technically known as the *oscillator padder*, because it is connected in series with the tuned circuit of the oscillator. You will learn later that this trimmer is adjusted to make the tuning dial readings more accurate at the low-frequency end of the tuning dial.

## R. F. Coils

There are two *r.f. coils* (radio frequency coils) under the chassis. Each r.f. coil has the basic construction shown in Fig. 20, in which there are two windings placed side by side on a waxed cardboard or Bakelite coil form. These windings may either be in a single layer as shown in Fig. 20,

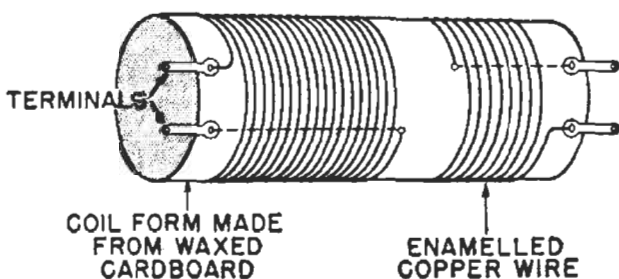

FIG. 20. Construction of an r.f. coil.

in many layers wound one over the other in a criss-cross manner as they are on one of the coils in this receiver, or even with one coil wound right over the other.

One of the r.f. coils is known as the *antenna coil*, because it has a direct connection to the antenna terminal of the receiver. Its job is to transfer the incoming modulated r.f. carrier signal from the antenna circuit to the grid circuit of the mixer-first detector tube.

The other r.f. coil is known as the *oscillator coil*, because it is a part of the tuned circuit of the r.f. oscillator.

These r.f. coils work hand in hand with the two sections of the gang tuning condenser to let only the one desired carrier signal get through the receiver.

R.F. coils have much the same troubles as i.f. transformer coils. Thus, they may have broken wires or poor connections at terminals. Sometimes adjacent turns of wire may touch each other and cause shorted turns. When a radio man finds that an r.f. coil is defective, he invariably replaces the coil with a new one, because it is difficult to make satisfactory repairs with the very fine wire used in winding these coils.

### Power Transformer

When you see a large, heavy unit like that in Fig. 21 on top of the chassis of a radio receiver, you can be sure it is the *power transformer*.

All connecting wires for the power transformer in our receiver are underneath the chassis. The wires have various colors for purposes of identification.

**Construction.** A power transformer consists of a number of separate coils of insulated wire, wound one over the other on a core made from thin strips of soft steel stacked together.

**Purpose.** The power transformer in a radio set transforms the a.c. power line voltage to the various higher and lower a.c. voltage values which are required by the tubes in the receiver. The more tubes there are, the larger must be the power transformer if it is to supply these tubes with the required electrical power without getting too hot.

**Possible Troubles.** There are a number of defects in receiver circuits which can place an *excessive load* on the power transformer. Overloading causes a power transformer to get hot, and this excessive heat damages the insulation between the windings of the power transformer.

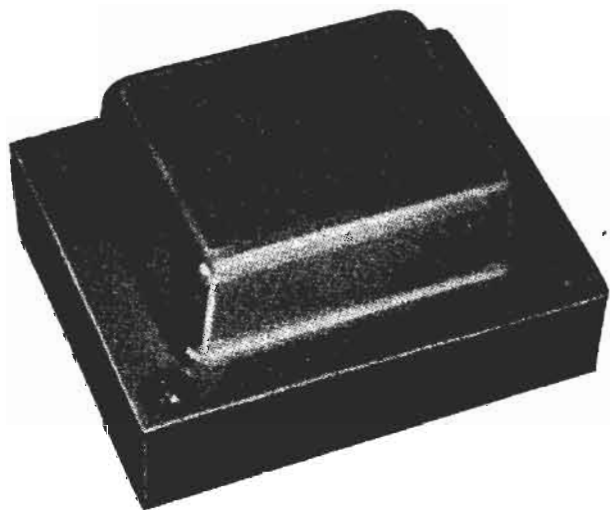

FIG. 21. The power transformer in a radio set is a heavy, bulky unit. It is covered with a metal cap for two reasons, to protect prying fingers from the high voltages that exist in the coils of wire inside, and to prevent the magnetic effects inside from escaping and interfering with other parts.

When the insulation on the wires or between the coils of a power transformer loses its insulating qualities because of heat, adjacent turns touch each other and cause a short circuit. This allows more current to flow, and produces still more heat. The condition becomes worse and worse. Eventually the trouble becomes so bad that the wire in the transformer

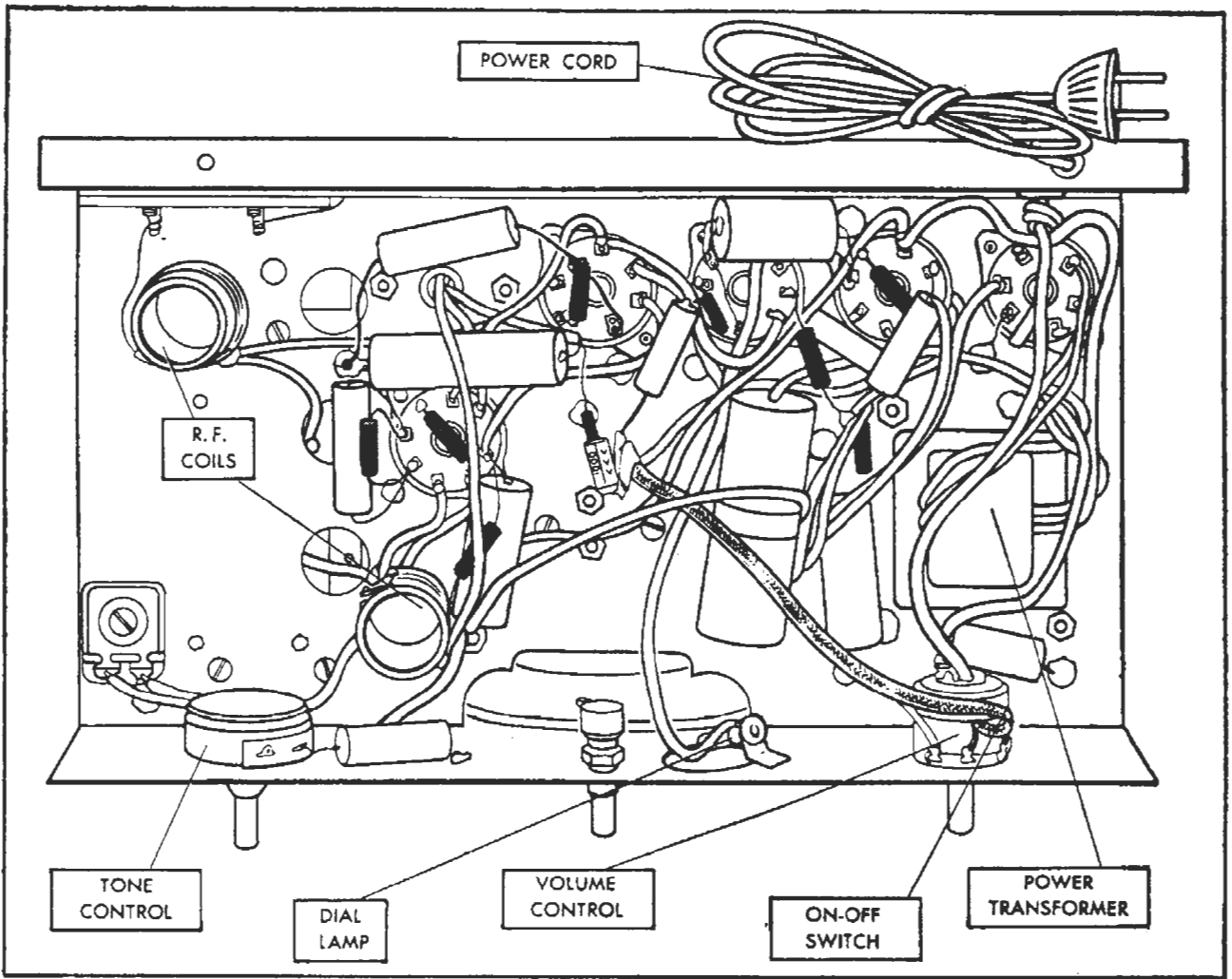

FIG. 22. Additional under-chassis parts of our superhet receiver are identified in this view.

melts and opens up at some point, causing complete failure of the receiver.

A radio serviceman often relies upon his nose to tell him when a power transformer is bad. Failure of this part is usually due to the overheating just described. The resulting smell of burned insulation is easily recognized, hence a radio man suspects the power transformer first of all whenever he encounters this strong, unpleasant odor of burned insulation.

An ordinary break in one of the wires inside a power transformer is rather rare, and yet may happen occasionally. Either voltmeter or ohmmeter measurements at the power transformer would reveal this trouble.

Poor connections at the power transformer terminals would have a similar effect.

Defective power transformers are replaced rather than repaired. The replacement offers no difficulty if you make a careful diagram of the original connections before disconnecting the damaged transformer.

### Other Under-Chassis Parts

As you can see in Fig. 22, there are still quite a few parts underneath the chassis of our receiver which have not yet been taken up. Most of these are highly important parts which often require attention by a radio serviceman, so a brief study of each will be well worth while.

**Power Cord.** One trouble which



occasionally baffles even the most expert radio man because of its very simplicity and obviousness is a *defective power cord*. This cord, shown in Fig. 22, serves to connect the receiver to an a.c. power line. The cord has a standard wall outlet plug at one end, and the two leads at the other end connect to two points underneath the chassis of the receiver.

The most likely places for trouble to occur in a power cord are at the plug, at the receiver connection, and at the point where the cord passes through a hole in the chassis. Examine all these places carefully for poor connections or damaged insulation.

The rubber used in a power line cord ordinarily lasts only about five years. Therefore, whenever you encounter an old receiver having brittle or cracked rubber insulation on the power line cord, it is best to install a new cord. The replacement job is quite simple, as it involves the resoldering of only two connections.

Always examine the power cord plug carefully whenever you work on a receiver, to make sure that there are no loose strands of wire which might eventually touch the opposite terminal of the plug and cause a short which would blow the fuses in the house. Tighten the screws in the plug if they are loose.

**On-Off Switch and Volume Control.** As you already know, a single control knob serves for both of these parts. The on-off switch is mounted at the back of the volume control. The switch is connected in series with one of the power cord wires, so that it can open the power supply circuit.

The on-off switch rarely gives trouble. About the only thing you need watch for is a poor connection at either of the two switch terminals.

The volume control is definitely a trouble-maker, however, in any radio receiver. In this set, it is in the circuit of the second detector, and governs the strength of the audio signal, which is fed into the first a.f. stage by the second detector.

The volume control in this receiver is a type of variable resistor which consists of a strip of carbon resistance material, and a rotating contact arm which sweeps over the carbon material. The contact arm can be set to make contact at any desired point along the resistance material.

If the carbon material in a volume control wears away through repeated use, or if the contact arm becomes loose, we have the equivalent of a poor connection. The radio man says the volume control has become *noisy*, because a noise is heard from the loudspeaker every time the control is adjusted.

The only remedy for a noisy volume control is replacement with a new volume control. It is usually customary to order a new switch at the same time, since the two are furnished as a single unit.

If you make a rough picture diagram of the connections to a defective volume control before removing it, you should have no trouble in making connections to the new unit. Even experienced servicemen follow this procedure, to reduce chances for mistakes.

*Shielded Wire.* One of the leads going to the volume control in our receiver is enclosed in a tube of braided wire which serves as a shield. This shield is necessary to prevent that particular wire from being affected by stray electric and magnetic fields around the chassis. Without this shielded wire, the set might have an annoying squeal or hum.

**Tone Control.** The tone control circuit in this receiver consists of a variable resistor connected in series with a condenser in the audio output stage. The condenser side-tracks the higher audio frequencies, and the variable resistor determines *how much* the higher frequencies will be side-tracked or suppressed. This variable resistor thus controls the *tone* of the program coming from the loud-speaker.

The tone control resistor is less likely to cause trouble than the vol-

There is only one wire connection to the dial lamp and to each tube filament, because the circuit to the other terminal is in each case completed through the metal chassis. This arrangement is common practice in radio sets, and is illustrated in Fig. 23.

A dial lamp has about the same life as an ordinary electric light bulb in a home, and hence requires replacement occasionally. The easiest way to insure getting the correct new lamp is to take the old bulb to the radio supply store and ask for a similar new bulb.

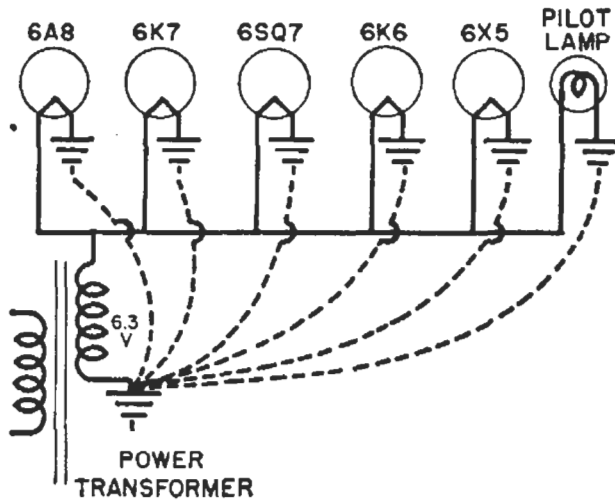

FIG. 23. Filament circuit, with dotted lines indicating the connections that are completed through the chassis of the receiver. All tube filaments and the pilot lamp require 6.3 volts, and the transformer secondary provides this voltage.

ume control, but the two parts are similar and do have the same types of trouble.

**Dial Lamp.** Mounted behind a hole in the front of the chassis is a small socket containing a *dial lamp*, also known as a *pilot lamp*. This lamp illuminates the tuning dial when the receiver is turned on, and thus also serves to indicate whether or not the receiver is turned on. The dial lamp in our receiver requires a voltage of 6.3 volts, the same as the filaments of the tubes in the set. The lamp is therefore connected in parallel with the tube filaments.

When ordering a dial lamp by mail from a catalog, select one having the same type of base, the same voltage rating, and the same color of glass bead inside the lamp as that in the original. The color of this glass bead is a clue to the current required by the lamp.

In some receivers, the color of the glass bead is unimportant, but in others the wrong pilot lamp can definitely cause tubes in the receiver to burn out, as you will learn later.

**Tube Sockets.** The five tube sockets on the chassis of this receiver are of modern design, and rarely if

ever give trouble. However, on older sets you will occasionally encounter tube socket contacts which do not grip the tube prongs tightly enough. If it is impractical to tighten the socket clips sufficiently, a new socket must be installed. The installation of a new tube socket should offer no difficulty to you even right now, if you make a careful sketch showing how connections were made to the various terminals of the old socket before you remove it.

When sockets are riveted to the chassis, they can be removed by drilling out the rivets. The new socket can be mounted with bolts and nuts or with new rivets.

**Conclusion.** Remember that failure of a radio receiver is due to some

simple breakdown in one or more of its parts. The breakdown is purely mechanical, such as a broken wire, a defective terminal, or parts touching each other. Usually the breakdown can be seen if you go to the trouble of taking the defective unit completely apart.

Of course, it is impracticable to take apart every unit in a receiver when hunting for trouble. You won't have to do this, because the knowledge of how radio parts work in circuits and the radio servicing techniques you learn in the NRI Course will enable you to locate defective parts speedily with simple test instruments. In some cases, you will even be able to spot the guilty part by noting the manner in which an ailing receiver is operating.

---

## Radio Receiver Servicing Techniques

If you have twelve identical radio receivers all with the same trouble, and give these receivers to twelve different radio servicemen for repair, the chances are pretty good that each man will use *a different method* for locating the trouble!

This is an entirely normal condition, because radio servicing techniques depend a great deal upon the amount of training and experience a man has. All twelve men will undoubtedly find the trouble, but some will find it much faster than others, because their methods are more efficient.

To illustrate some of the methods which could be used to find trouble in a receiver, let us imagine that you have a defective receiver for repair.

**Check of Performance.** All servicing methods start with a thorough

check of performance, to see just how the radio receiver is misbehaving. Oftentimes this check gives valuable clues to the source of trouble.

To make a performance check, you plug the receiver power cord into a wall outlet, make antenna and ground connections if the set does not have a built-in aerial, then turn on the receiver and attempt to tune in stations. You note how the volume control, the tone control, and any other controls affect performance. Your training and experience have taught you to pay particular attention to unusual squeals, noises, or hum, because each tells its own story of trouble.

**Testing Tubes.** Since bad tubes are common causes of trouble in receivers and since tubes are easily tested, your next step is a test of each tube in the receiver. Tubes should

be tested at some point in the servicing procedure anyway, so this might as well be done first of all since it is so easy.

A beginner might prefer to check the tubes later if he didn't have a tube tester, for he would usually have to take the tubes to some reliable store for testing.

An expert serviceman might be able to figure out where the trouble is just by listening to the receiver, and clear up the trouble before making a routine check of the tubes. In the great majority of cases, however, you will find that tube testing comes first on the serviceman's list of trouble-hunting techniques.

Your aim in servicing is to narrow down the trouble first to a section of the receiver, then to a stage, and finally to just one circuit and to a particular part in that circuit.

The average superheterodyne receiver can be divided into six sections for servicing purposes. The *preselector* section includes all circuits between the antenna and the mixer-first detector. The *frequency converter* section includes the local r.f. oscillator stage and the mixer-first detector stage. The *i.f. amplifier* includes all i.f. stages and i.f. transformers. The *second detector* is just one stage. The *audio* section covers everything following the second detector, including the loudspeaker. The *power pack* section includes the rectifier tube and its associated parts.

Sometimes an experienced, properly trained serviceman can tell the section containing the trouble just by listening to how the receiver is misbehaving. If the faulty section has more than one vacuum tube stage, he then makes simple tests which isolate the defective stage.

Other servicemen prefer to start

right in with tests which locate the defective stage. Let us select just two of these tests now, and see how you would carry them out.

**Circuit Disturbance Test.** For a dead receiver, the simple circuit disturbance test is one of the fastest and most effective of these tests for locating the defective stage. It is carried out by introducing an electrical disturbance in each tube circuit in turn while the receiver is turned on.

You start at the audio output stage (next to the loudspeaker) and work backward through the stages when carrying out the circuit disturbance test. The disturbance which you introduce causes a click or thump in the loudspeaker when all the stages between the point of disturbance and the loudspeaker are good, but no click is heard when you arrive at the defective (dead) stage.

The electrical disturbance for this test can be inserted in a stage by removing a tube momentarily, by touching the top cap of the tube if there is one, by removing and replacing the top cap, or by shorting the grid of the tube momentarily to the cathode of the tube.

Since you must go from tube to tube in a definite order if a circuit disturbance test is to be effective, one requirement for making this test is the ability to identify the various tubes on top of the chassis.

**Stage-Isolating Procedure.** For some receiver troubles, such as low volume, you introduce a test signal in one stage after another, working toward the antenna. Again the loudspeaker tells when you have come to the defective section or stage, because the introduced signal will increase in volume for good stages but not when you move through the defective stage. For each other type of receiver com-

plaint, there are one or more professional techniques for tracing the trouble.

**Locating the Defective Part.** Having located the defective stage in our ailing receiver, you could now follow the practice of some servicemen and begin testing the parts in the defective stage, one after the other. This eventually locates the defective part, but it can take a lot of valuable time.

A professional radio serviceman, however, would make additional general tests which gradually narrow the trouble down to a particular circuit in the stage. Then, by testing only a few radio parts at the most, he would locate the defective part in the quickest possible time.

It is in locating the defective stage and circuit that we find such a great variety of servicing techniques. There is no one technique which can be considered the best for all jobs; each has its own advantages, and will work best in a particular job. If you choose radio servicing for your advanced study, you will learn these servicing techniques and will also learn when to use them most effectively.

**Short Cuts.** After years of experience in radio servicing, a man learns to associate certain ailments and symptoms of a receiver with definite defects. He can then take short

cuts through the general servicing procedure which bring him more rapidly to the defective part. One important requirement for taking any short cuts, however, is a thorough knowledge of radio fundamentals. Unless these are thoroughly mastered, radio servicing becomes an unprofitable guess-and-try proposition.

**Guess-Work Won't Pay.** If you consider how many different tubes, resistors, coils, condensers, transformers, connections, and other parts there are in a radio receiver, the folly of expecting to service radio receivers simply by testing one part after another without thinking becomes clearly evident.

### Looking Ahead

Having now completed the groundwork for your study of radio, you are ready to add to your knowledge of how radio parts work and what they do.

In the next Lesson you will study different types of resistors, and learn how they are used in practical radio circuits to control voltage and current. The two following Lessons will cover coils and condensers in the same thorough manner.

This next group of three Lessons will thus complete your knowledge of three important parts used in radio circuits.

# Lesson Questions

**Be sure to number your Answer Sheet 4FR-3.**

**Place your Student Number on every Answer Sheet.**

***Send in your answers for this Lesson immediately after you finish them, as instructed in the Study Schedule. Do this, and get the greatest possible benefit from our speedy personal grading service.***

1. If there is no set screw on the control knob of a receiver, how would you remove the knob?
2. Why is a shield placed around one of the tubes in our superheterodyne receiver?
3. Name three ways in which radio tubes commonly fail.
4. If a radio receiver sounds distorted, and you can hear a rubbing sound when you push the loudspeaker cone in and out with your fingers, what is the trouble?
5. You are tuning a radio receiver towards one end of the dial. The set suddenly goes dead as you tune, and all you can hear is the noise caused by the gang tuning condenser plates scraping against each other. How would you correct this trouble?
6. State briefly the purpose of the small trimmer condensers which are mounted on top of the gang tuning condenser.
7. What type of meter is ordinarily used to locate shorted or leaky paper condensers?
8. What happens to a power transformer when you overload it by drawing too much current from it?
9. How many connections must be unsoldered in order to disconnect the power cord of an a.c. superheterodyne receiver like that studied in this Lesson?
10. At what stage do you start, when using the simple circuit-disturbance test in a dead receiver?

# STUDY SCHEDULE NO. 4

To master this fourth part of your NRI Course most speedily and thoroughly, divide your study into the steps given below. First read the specified pages at your usual reading speed. Next, reread them slowly one or more times, endeavoring always to *understand* as well as remember. Finish with one quick reading to tie the ideas together in your mind, then write on scrap paper your answers to the questions specified for that step. After finishing the Lesson, copy all answers neatly on an Answer Sheet.

1. **We Study a Modern Radio Receiver.....Pages 1-5**

Read this section at least once, to find out *why* a knowledge of radio receiver servicing problems is important to *YOU*, to get a *preview* of how receivers are taken up in this Lesson, to study a *radio map* which will guide you through a modern superheterodyne receiver, to become acquainted with the knobs and dials on the front of a receiver, and to learn how the chassis is removed from the cabinet of a receiver. Answer Lesson Question 1.

2. **Radio Receiver Tubes.....Pages 6-10**

Since a tube is one of the most important parts in modern receivers, you study first the five tubes used in the average superheterodyne receiver which serves as our example for this Lesson. Tubes will mean a lot more after you finish this interesting section. Answer Lesson Questions 2 and 3.

3. **Above-Chassis Parts.....Pages 10-17**

You take up one by one the parts which are mounted on top of the chassis of our superheterodyne receiver—the loudspeaker, the output transformer, the gang tuning condenser, the trimmer condensers, and the i. f. transformers. You find out how each one is constructed, what it does, how it might fail, and how it is repaired or replaced. Answer Lesson Questions 4, 5, and 6.

4. **Under-Chassis Parts.....Pages 17-26**

You turn the chassis upside-down, and study in turn, the soldered joints, resistors, condensers, r. f. coils, power transformer, power cord, on-off switch and volume control, tone control, dial lamp, and tube sockets. Answer Lesson Questions 7, 8, and 9.

5. **Radio Receiver Servicing Techniques.....Pages 26-28**

Here's your first real introduction to actual servicing techniques. You learn how a radio man uses various techniques to find first the defective section or stage, then the defective circuit, and finally the defective part. Answer Lesson Question 10.

6. **Mail Your Answers for Lesson 4FR-3 to NRI for Grading.**

7. **Start Studying the Next Lesson, on Resistors.**