

**USING THE CATHODE RAY
OSCILLOSCOPE IN RADIO
SERVICING**

40RH-2

NATIONAL RADIO INSTITUTE

ESTABLISHED 1914

WASHINGTON, D. C.



STUDY SCHEDULE NO. 40

For each study step, read the assigned pages first at your usual speed, then reread slowly one or more times. Finish with one quick reading to fix the important facts firmly in your mind. Study each other step in this same way.

1. **How the Oscilloscope Works** **Pages 1-6**

A review of the fundamentals of the c.r.o. is followed with more details on the construction and operation of this valuable tube. How the electron beam is obtained and a deflection obtained must be known, so the patterns formed can be clearly understood.

2. **A Typical Commercial C.R.O.** **Pages 6-12**

A standard c.r.o., designed for service work, is described in a step-by-step manner, so you will know just what the controls are for, and can operate any similar type you may encounter. The special amplifiers and their switching arrangements are covered. Here you find practical information and warnings, so you will not damage the tube. Peculiarities produced in the image by improper control settings and by stray voltages are portrayed so they can be minimized or avoided.

3. **Putting the C.R.O. to Work** **Pages 12-22**

How to use the c.r.o. for determining frequency; signal tracing for hum, oscillations and distortion; types of distortion and the meaning of the patterns seen; determining phase. All these uses are covered in this section, which is packed with practical information. The every-day applications of the c.r.o. are set forth, so you can properly use this service tool, should you obtain one.

4. **High Fidelity Alignment** **Pages 23-36**

The c.r.o. is an absolute requirement for speedy alignment of a high-fidelity receiver. By using a frequency-modulated signal generator, the c.r.o. will show the response curve of the r.f. and i.f. stages, so that the desired band-pass characteristic can be obtained. Further, the wave form shows exactly when resonance is reached, and the exact width of the pass band, permitting accurate adjustment.

5. **Answer Lesson Questions and Mail Your Answers to N.R.I.**

6. **Start Studying the Next Lesson.**

USING THE CATHODE RAY OSCILLOSCOPE IN RADIO SERVICING

How the Oscilloscope Works

THE cathode ray oscilloscope has become one of the most useful measuring instruments known to modern science. It not only can measure electricity, it actually makes the whole *character* of the wave visible at one time, so that every aspect of it can be studied. Even more—the time relationships between waves are instantly visible. It thus gives an actual picture of what is going on, not only in radio circuits but in every kind of moving or vibrating phenomenon that can be converted into equivalent electrical wave forms. Any variation, such as sound through a microphone; vibration through a pressure-actuated pick-up; light variations through a photoelectric cell; or heat fluctuations through a thermocouple, all become visible and give up the secrets of their nature on the screen of the oscilloscope.

► To the radio serviceman, the oscilloscope is not a basic instrument like the multimeter or signal generator, but is one of the “extras” that can be acquired, as finances permit, to make speedier, better service work possible. It can be used to compare voltages, to measure frequency, to show response curves of an amplifier, to show the presence of, and quickly find the source of distortion, hum or oscillation. It can be used as a signal tracer and is essential for proper alignment of high-fidelity equipment.

► This lesson will describe how to use the c.r.o. for these purposes, showing how the instrument can make service work more rapid, accurate and efficient.

THE C.R.O. TUBE

First, let us review briefly the fundamentals of the c.r.o. itself, which have been covered elsewhere in your Course.

The Electron Gun. A cathode ray tube, like any other radio tube, has an electron-emitting cathode, control elements and an anode. However, the c.r.o. shoots its electrons in a thin stream at a fluorescent screen to produce light. Besides the cathode, which emits the electrons, there are three elements in the electron gun which are used to make the electrons move toward the fluorescent screen at high velocity and in a very narrow stream. These elements are shown in Fig. 1A and are the grid G , the first anode P_1 and the second anode P_2 .

The grid, as shown in Fig. 1B, is like a tin can open at one end, with a hole in the closed end. Electrons are pulled through the small hole in its closed end.

The first anode, P_1 , is a cylinder with a “baffle” in the middle, having another small hole. It is made positive to attract the electrons and get them moving so rapidly they tend to move in a

straight line, and nearly all go through the small hole in the baffle.

The second anode, P_2 , is more positive than the first anode. It thus gives

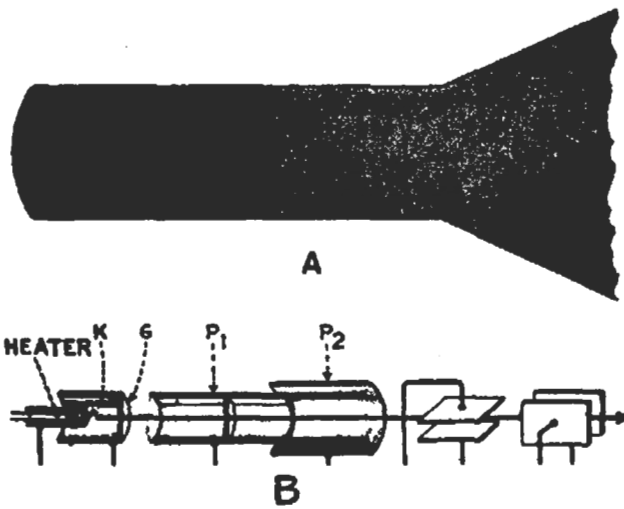

FIG. 1. The parts of the electron gun, arranged in the neck of the tube.

even more speed to the electrons which are emerging from the hole in the baffle. In addition, its electrostatic field, in combination with that of P_1 , produces curved lines of force which actually focus the moving electrons into a point at the screen, much in the way that a lens focuses light rays.

► Thus, as shown in Fig. 2, the electrons are emitted by the cathode, are controlled as to quantity by the adjustable negative potential on the grid, are accelerated and made to emerge from a small hole by the first anode, are further accelerated by the second anode, and are "focused" so that, after traveling the length of the tube, they come together in a small spot on the screen at the end of the tube. The potential on P_1 is variable so that an exact focusing of the beam at the screen can be obtained.

► The screen is coated with fluorescent chemicals which will produce light when struck by electrons. The greater the number of electrons striking a given point, the brighter the light produced there. Varying the voltage on

the element G controls the quantity of electrons in the stream, thus controlling the brilliancy of the spot of light on the screen.

Obtaining a Deflection. Now, with a stream of electrons striking the screen and producing a spot of light, we must deflect the stream up and down and to the right and left, to sweep the spot of light across the screen and get varied line patterns.

Two pairs of deflecting plates are used, the beam passing between the plates of each pair. (See Fig. 1B.) If one plate of a pair is made positive with respect to the other plate, the electron beam will be attracted toward this positive potential, since the beam is made of negatively charged particles.

► One plate of each pair, as shown in Fig. 3, is connected to anode P_2 so that the plates will normally be at the same potential as P_2 and thus not defocus the beam. Notice that it is the voltage difference *between* the plates which produces the deflection, not the fact that a connection is made to P_2 .

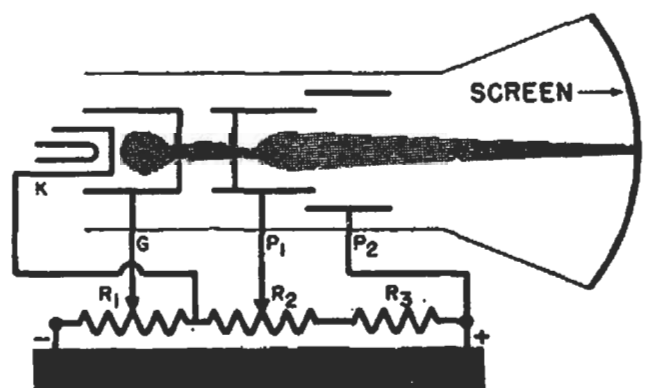

FIG. 2. How the electron beam is obtained.

Since this deflecting voltage will usually be found between chassis and some other point, it is convenient to ground the two plates connected to anode P_2 . This means that the high positive potential of P_2 is connected

to the chassis, which is different from the usual receiver practice, but does not affect the power supply operation.

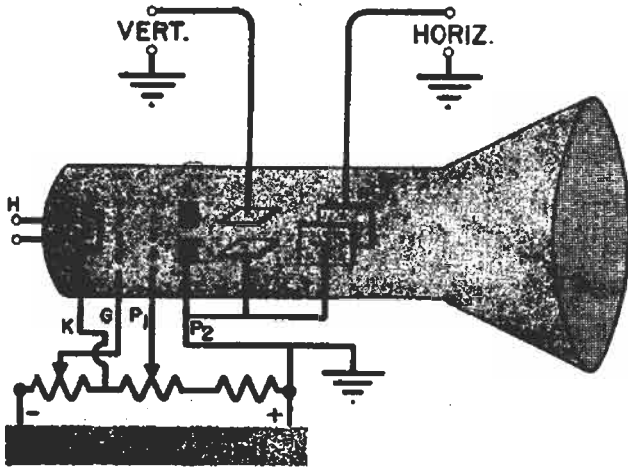

FIG. 3. The symbols used here are those commonly found on schematic diagrams representing the c.r.o. tube. Notice the connections to the deflecting plates.

► Fig. 4 shows how the position of the spot of light is affected for different deflecting voltages applied to the deflecting plates. At *A* you see a view of the tube as you would see it when looking right at the screen. (The deflecting plates are indicated on the drawing, although they cannot actually be seen from the front of the tube.) The spot here is in the middle between the vertical deflecting plates 1 and 2 which make up and down motions of the spot, and the horizontal deflecting plates 3 and 4 which cause side-to-side motion. (Notice the plates are named for the direction of deflection, not their physical position.)

A voltage on *V*, with none on *H*, making plate 1 positive, moves the spot up as shown in Fig. 4*B*. Reversed polarity sends the spot down as in Fig. 4*C*. An a.c. voltage applied to *V* will obviously keep the spot moving up and down in a line, as in Fig. 4*D*. If the spot moves faster than 16 times a second, the persistence of vision in the human eye makes us see a solid line instead of a moving spot.

Figs. 4*E*, 4*F* and 4*G* show what happens to the spot if the voltage is applied to the horizontal plates instead of the vertical plates. The solid line formed by an a.c. voltage is now from side to side rather than up and down. Since the length of this line is proportional to the peak of the applied voltage, the voltage can be measured by comparison with a known voltage, or by actual calibration in terms of the length of the line.

► The great value of the c.r.o. does not lie in measuring voltages, however, but in making visible the actual form of an a.c. wave. You might reason that we could apply the a.c. voltage to both sets of plates at the same time. This makes one plate of each pair positive at the same instant, as shown in Fig. 5*A*. The electron beam is pulled to the left and upward at the same time, so it moves along the diagonal to the

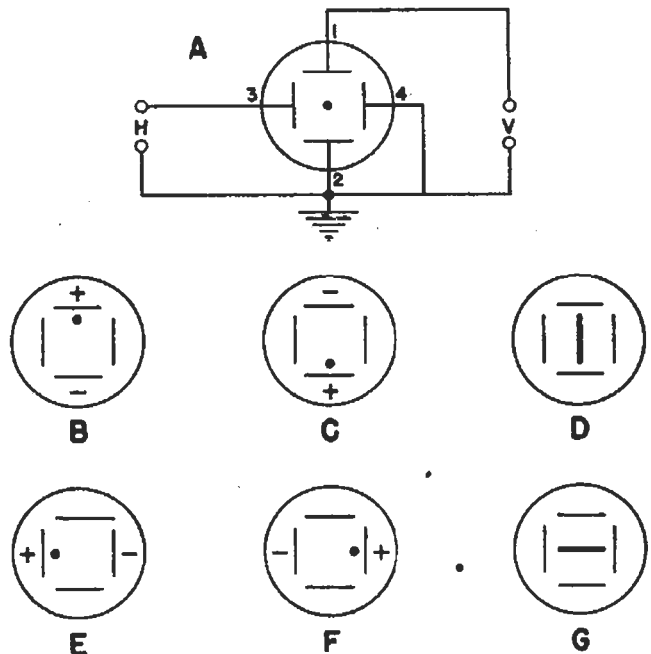

FIG. 4. The result of applying a voltage to just one set of deflecting plates.

upper left. When the polarities reverse, we have the condition shown in Fig. 5*B*. Thus, we have formed a diagonal line as shown in Fig. 5*C* instead

of getting a picture of the wave. This same line will be formed regardless of the wave shape, as long as the *same* voltage is applied to both sets of plates directly.

► Let us see what can be done to make the wave shape visible. Since we are trying to view the wave form, this gives a clue as to what is necessary.

When we draw a curve showing the form of a wave, we are actually showing how the variations (voltage, in this case) are increasing and decreasing *with respect to time*. That is, the line of our curve moves steadily from left to right, to indicate the passage of time, and *at the same time* moves up and down, to show how the voltage rises and falls *during that time*. The resultant of these two motions is the curve which traces the form of the wave.

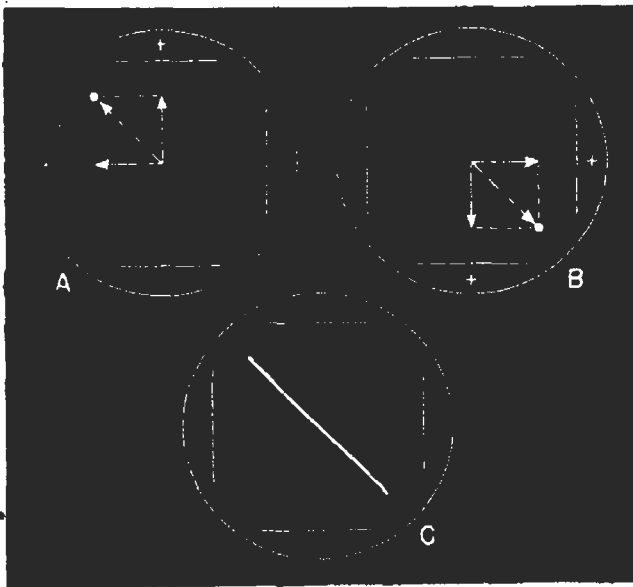

FIG. 5. Applying the same identical voltage to both sets of deflecting plates produces a tilted line.

Applying this to the c.r.o., we see that for the spot to trace the actual form of the wave, it must be moved steadily from left to right to indicate time, and at the same time must be moved up and down in response to the

voltage we want to "see." Therefore, it is customary to apply a "timing" voltage to the horizontal deflecting plates, and to apply the voltage that is to be analyzed to the vertical deflecting plates.

The resultant of these two movements will sweep the spot across the screen in the form of the a.c. voltage applied to the vertical plates.

► But one cycle of that wave would be swept across the screen and gone too quickly for the eye to see. Even the lowest audio wave, 20 cycles per second, would be gone before we had a chance to glimpse its shape. The c.r.o. makes the wave stand still by making it repeat itself over and over on the screen, for as long as we want to see it.

This repetition of the wave is accomplished by applying a "sweep" voltage to the horizontal plates. The sweep voltage carries the spot steadily across the screen from one side to the other, as the a.c. wave on the vertical plates is going through its cycle, and then the sweep voltage snaps the spot back to the beginning just in time to start the process over again, at the same point in the a.c. wave. Such a voltage is known as a "saw-tooth" voltage and is produced by a circuit like that in Fig. 6A.

Essentially, condenser C_1 is charged through resistor R_2 to the point where the voltage across C_1 equals the breakdown voltage of the special gas tube VT . When this critical voltage is reached, the tube begins to pass current, which ionizes the gas and reduces the tube plate-cathode resistance to a very low value, so the condenser discharges through the tube. The very low plate-cathode resistance causes most of the plate supply voltage to be dropped in R_2 , leaving too little for the tube to maintain ionization, so the tube ceases to conduct. At this point,

condenser C_1 is again charged from the **B** supply through resistor R_2 and the cycle is repeated. The frequency of the sweep voltage can be adjusted by varying condenser C_1 and resistor R_2 , as the frequency is dependent on the time constant of the R_2 - C_1 combination. The voltage developed across the condenser has the saw-tooth wave shape shown in Fig. 6B, and is taken from the output terminals through condenser C_2 . This condenser blocks the d.c. so that the desired saw-tooth a.c. voltage can be applied to the horizontal plates.

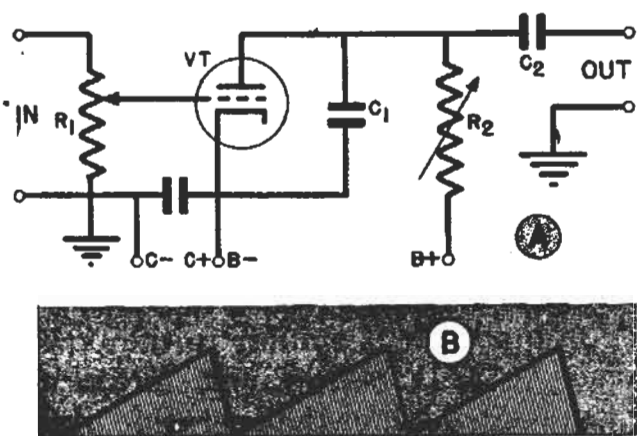

FIG. 6. A typical sweep generator and the wave form produced.

► The gas discharge tube VT , although it has a grid, does not work exactly like the ordinary vacuum tube. The amount of grid bias will set the voltage at which the tube will start conducting, after which the grid has no further control over plate current, until the plate current is stopped by the plate voltage dropping. This allows the grid again to assume control, repeating the cycle.

The grid is normally used as a means of synchronizing the saw-tooth frequency accurately with the voltage under study. By setting the sweep controls so that the saw-tooth frequency is just under that of the applied signal, and then applying a small voltage from this signal to the grid of the

sweep tube, the saw-tooth voltage is made to "lock in" with the signal under study. The tube is unblocked at exactly the right intervals by the control pulses making the grid less negative, forcing the R - C circuit to "jump" into step every cycle. This overcomes any frequency drift in the sweep circuit because of changes in plate voltage, etc., and forces the sweep and the applied signal to stay together, or to synchronize.

PRODUCING THE IMAGE

With this sweep voltage applied to the horizontal plates and an a.c. sine wave applied to the vertical plates, the resulting image can be plotted as shown in Fig. 7, to give a clear picture of how the two combine in producing the motion of the spot.

The sweep frequency B must exactly equal the sine wave frequency A to produce the image shown at C . Sup-

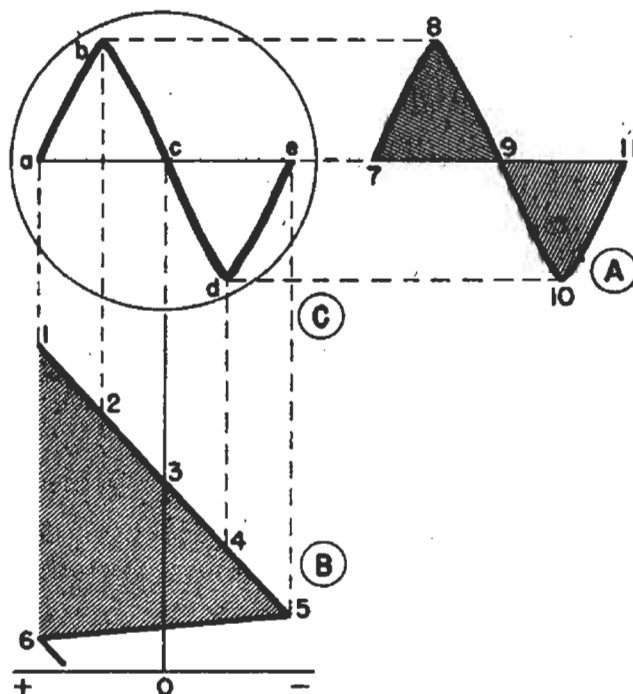

FIG. 7. Applying a sweep voltage to the horizontal deflecting plates and a sine wave to the vertical deflecting plates produces a sine wave pattern on the screen.

pose that point 1 on the saw-tooth wave represents a positive voltage on

the plate to the left, when looking at the face of the tube. Then the electron spot will be moved to position *a*. At this moment the sine wave is just starting from position 7.

As a saw-tooth wave changes from position 1 to position 2, the sine wave during the same time has moved from 7 to 8 so the spot will have moved to the position where the dotted lines intersect. This will be position *b*. Similarly, the spot is moved to positions *c*, *d*, *e* and then back to *a*.

The return of the spot from *e* to *a* is produced by the saw-tooth wave between points 5 and 6. The spot is being moved very rapidly across the face of the tube and, as a result, few electrons have time to hit any one point on the screen. This means that this back-trace is very faint; in fact, you may have to turn up the intensity control somewhat even to see it.

When the spot returns to *a*, the pattern is retraced and this action is repeated over and over again.

A Typical Commercial C.R.O.

We have now discussed the fundamental action of the c.r.o., and shown in detail the formation of an image on the screen by the combination of a sweep voltage and an a.c. signal. Before going on to explain the methods of using the c.r.o. in practical servicing, let us look at an actual commercial c.r.o., to see what controls are usually provided and how they affect operation. An understanding of this instrument will allow us to use most commercial instruments intelligently, since they are usually operated in a similar manner, even though the controls may have different names and positions.

THE C.R.O. CIRCUITS

Before studying the setting of the controls, we should have an understanding of the circuits in the c.r.o., so we can know just what the controls do.

Fig. 8 is the wiring diagram and Fig. 9 shows the controls and general appearance of the RCA 155, chosen as an example of a typical service instrument. The instrument has in it a cathode ray tube, a high-voltage power supply, amplifiers for the horizontal

and vertical voltages, and a sweep generator.

Power Supply. There are two complete power supplies in Fig. 8. The section using rectifier VT_2 is the low voltage supply. It is similar to the power pack in a large receiver, furnishing about 400 volts for the operation of the amplifiers and sweep circuit. As this is a rather high d.c. voltage, the filter condensers are in series, to increase the voltage rating. Thus, condensers C_{19} and C_{20} together give half the capacity and twice the voltage rating of a single condenser.

The c.r.o. tube requires about 1000 volts for operation. Such a high voltage from a single power supply would mean a special rectifier tube and expensive power transformer. Instead, here the high voltage pack, using tube VT_1 , furnishes 600 volts, and its output is connected in series with the 400-volt supply, thus furnishing the needed 1000 volts.

A single high-voltage power transformer winding is used, tapped for the low voltage supply. The rectifier VT_1 is connected in the *negative* side of its circuit, so the output voltages can be

added and this single transformer winding used.

As the d.c. current required by the c.r.o. tube is extremely small, resistor R_{13} can be used in the high voltage filter without appreciable d.c. drop. The filter condensers C_{12} and C_{13} are paper condensers, oil impregnated, capable of withstanding 1000 volts. Small capacities can be used here as the low drain does not appreciably discharge the input condenser and the R_{13} - C_{13} combination gives sufficient filtering.

► High voltages are dangerous—NEVER take an oscilloscope out of its cabinet for repairs until it is disconnected from the power line. DON'T WORK ON ONE WHILE IT IS CONNECTED TO THE POWER LINE. You can use an ohmmeter, with the oscilloscope OFF and disconnected from the power line, to find any ordinary trouble.

The C.R.O. Tube. The type 906 c.r.o. tube is shown as VT_6 , just to the right of the power pack. The elements, reading down, are: the filament, the cathode, the grid element, anode 1, anode 2, the vertical deflecting plates, and the horizontal deflecting plates. The d.c. potentials for the elements are obtained by tapping at different points on the voltage divider R_{14} to R_{21} inclusive, which is across the full output of the two power supplies in series. The c.r.o. grid is negative with respect to the cathode, and this voltage can be varied by adjusting R_{14} , the intensity control.

. Anode 1 is positive and R_{16} is adjustable for focusing. Anode 2 is near the positive end of the divider, and thus has nearly the full high voltage between it and the cathode.

The deflecting plates have one of each pair connected to anode 2, keeping them at the same potential as the

anode to prevent defocusing the beam.

Centering Controls. It is impossible to locate the tube elements in every tube so as to get the spot in the exact center of the screen when no deflecting voltages are applied. Controls R_{22} and R_{23} are included to permit accurate centering of the spot. Since the controls are connected across R_{20} and R_{21} , which are a part of the voltage divider, the controls have the same voltage across them. Anode 2 and the two deflecting plates connected to it are connected to the center of the divider section R_{20} - R_{21} . Thus, by moving the arms of R_{22} and R_{23} , which are connected to the other two deflecting plates, the potential on each of the "free" deflecting plates can be made either above or below that on the opposite one of the pair. This d.c. difference between the pair will move the spot toward the more positive plate; thus it is possible to make it move to the center of the screen.

After the beam has been centered and focused, and the intensity adjusted, we can apply voltages to the deflecting plates through C_2 and C_5 , thus developing a.c. voltages across resistors R_{24} and R_{25} .

Sweep Generator. The sweep generator is marked "timing" in Fig. 8 and uses the gas discharge tube VT_3 and a selector switch S_4 , which connects the proper condenser into the circuit for the frequency range desired. The condensers C_7 to C_{10} cover the range 15 to 22,000 cycles in four overlapping ranges. The chosen condenser is charged through R_{11} and R_{12} , the latter being adjustable to give a "fine" frequency control.

► The synchronizing transformer feeds the control signal into the timing tube grid through control R_8 . This control is set so locking is obtained but is not over-set—since too much con-

trol signal will distort the shape of the sweep voltage.

Vertical Amplifier. The signal to be viewed is usually applied to the vertical deflecting plates. The terminals are shown at the upper left in the diagram. When switch S_1 is set to the *OFF* position, the input signal is applied through C_2 directly to the vertical deflecting plates of the c.r.o. When S_1 is set to the *ON* position, the signal is fed through C_1 to the grid of the amplifying tube VT_4 . To obtain a flat response characteristic over a wide frequency band (excellent between 20 cycles and 35 kc., and usable to 100 kc.), the plate load is a combination of resistances R_3 , R_4 and inductance L_2 . The coil L_2 compensates for the normal high-frequency output drop (caused by plate-to-ground capacity) by acting as an increasing load with frequency, thus raising stage gain. The output is then fed through C_2 to the vertical deflecting plates.

Horizontal Amplifier. This stage is similar to the vertical amplifier. However, switches S_2 and S_3 need some explanation.

► In the position shown, S_2 and S_3 are set for an external synchronizing voltage. This voltage is applied from some standard frequency source to the *SYNC* terminals at the right of the diagram, going to the grid of the sweep tube through T_2 . The sweep output, thus controlled, is fed through R_{26} to the horizontal amplifier tube V_5 , and then through C_5 to the horizontal deflecting plates, the amplitude being controlled by R_5 .

► When switches S_2 and S_3 are set to the next position, 60-cycle a.c. is fed from the filament supply of VT_5 through S_3 to the input of the sweep, so the sweep frequency can be locked to this frequency or some multiple of it.

► In the next position of S_2 - S_3 , a part of the voltage under study on the vertical amplifier is fed to the sweep input and "locks" the sweep with it, as described in the basic discussion. This is the most used position of these switches.

► In the next position of S_2 - S_3 , the sweep is not in the circuit. Instead, an external signal can be fed into the *HORIZONTAL INPUT* terminals at the right, and through tube VT_5 to the horizontal plates.

► In the final position of S_2 - S_3 , the horizontal input terminals connect directly to the deflecting plates through C_5 , without the horizontal amplifier or sweep generator.

SETTING THE CONTROLS

The controls on different oscilloscopes may have different positions and names, so the manufacturers' instructions should be followed in all cases. However, suppose we wish to see the wave form produced by a 60-cycle power line, and intend to use the RCA 155 for this purpose.

Turning to Fig. 9, you will see that the controls on the front of the instrument are divided into four groups. Right underneath the tube, there are two controls labeled *INTENSITY* and *FOCUS*. Then there is a vertical group at the left, consisting of three controls and two binding posts. The head of this column is labeled *VERTICAL*.

Next to this is a group of three controls and two binding posts which are labeled *TIMING*. Then we have three controls and two binding posts which are labeled *HORIZONTAL*.

In order to put the instrument into operation, we should proceed to set these controls as follows:

Step 1. The *ON-OFF* switch is a part of the *INTENSITY* control. Turn the *INTENSITY* control until the

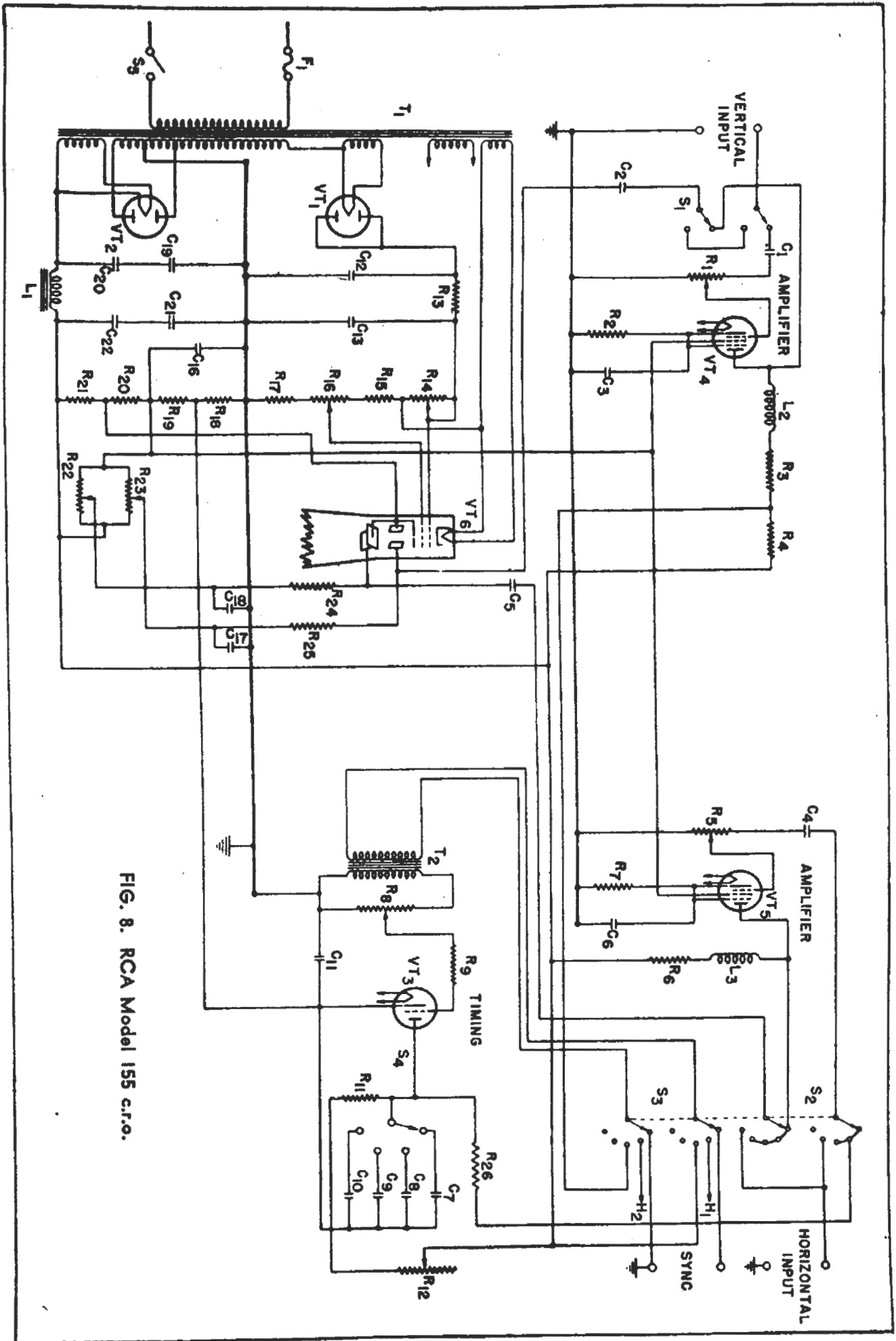

FIG. 8. RCA Model 155 c.r.o.

switch clicks *ON*, and wait for about a minute to permit the circuits to warm up. Then advance the *INTENSITY* control until a spot of light is seen on the screen. Don't turn the *INTENSITY* control too high, just turn it up so that the spot of light is barely visible. **THIS IS IMPORTANT—IF A BRIGHT SPOT OF LIGHT IS PERMITTED TO REMAIN AT ONE POINT ON THE SCREEN FOR AN APPRECIABLE PERIOD OF TIME, THE SCREEN CHEMICALS CAN BE BURNED AWAY, WHICH DESTROYS THE ABILITY OF THAT PARTICULAR SPOT ON THE SCREEN TO REPRODUCE LIGHT.**

Step 2. The spot focus should be adjusted, with both *GAIN* controls turned to zero to keep voltage off of the deflecting plates and thus eliminate any deflection of the spot into a line.

Rotating the *FOCUS* control will make the spot of light increase in size and spread into an irregular shape. The control should be adjusted so that the spot is as small as possible and perfectly round. If the spot is now too bright, turn back the *INTENSITY* control until the spot is just easily visible, being sure to eliminate any halo of light around the spot.

Step 3. The spot must now be centered, still with no voltages on the deflecting plates. The *VERTICAL* centering control (underneath the *INTENSITY* control) will move the spot up or down, and the *HORIZONTAL* centering control (underneath the *FOCUS* control) will move it to left or right. The spot should be moved by means of these controls to the exact center of the screen.

Step 4. As we will use the internal sweep, we must set the *HORIZONTAL AMPLIFIER* switch, S_2-S_3 on the schematic (at the lower right of the

front panel of the photograph) to *INT*, the position for control of the sweep by the voltage under study. This position is shown on the photograph. This connects the timing circuit input to the vertical amplifier, and its output to the horizontal amplifier.

Turn up the *HORIZONTAL GAIN* control (R_5 in Fig. 8) and the spot will turn into a faint horizontal line. Increase the intensity setting and the horizontal line will become brighter. When the spot begins to move, fewer electrons strike any given point on the screen in a given time, and brightness drops. It is safe to increase the number of electrons in the beam by adjusting the intensity control, since the spot does not stay in one position long enough to damage the screen. Adjust the *HORIZONTAL GAIN* control so that the line extends about two-thirds the distance across the face of the tube.

Step 5. To analyze a 60-cycle wave from the power line, the *RANGE* switch in the *TIMING* group must be set to the first range, which covers frequencies between 15 and 120 cycles. Remember, we want the sweep voltage frequency to be the same as our 60-cycle frequency.

Step 6. Now connect the voltage to be analyzed to the *VERTICAL* terminals, at the bottom left of the panel. You can get a voltage from the power line by using a step-down transformer, connecting the low-voltage winding to the c.r.o. terminals.

Step 7. Next, turn the *VERTICAL AMPLIFIER* switch to the *ON* position. Then advance the *VERTICAL GAIN* control until the line of light on the screen changes into some kind of pattern, most likely a series of rapidly moving lines or figures.

Step 8. Now rotate the *TIMING SYNC* control (R_8 in Fig. 8) to about mid position. We are now ready to ad-

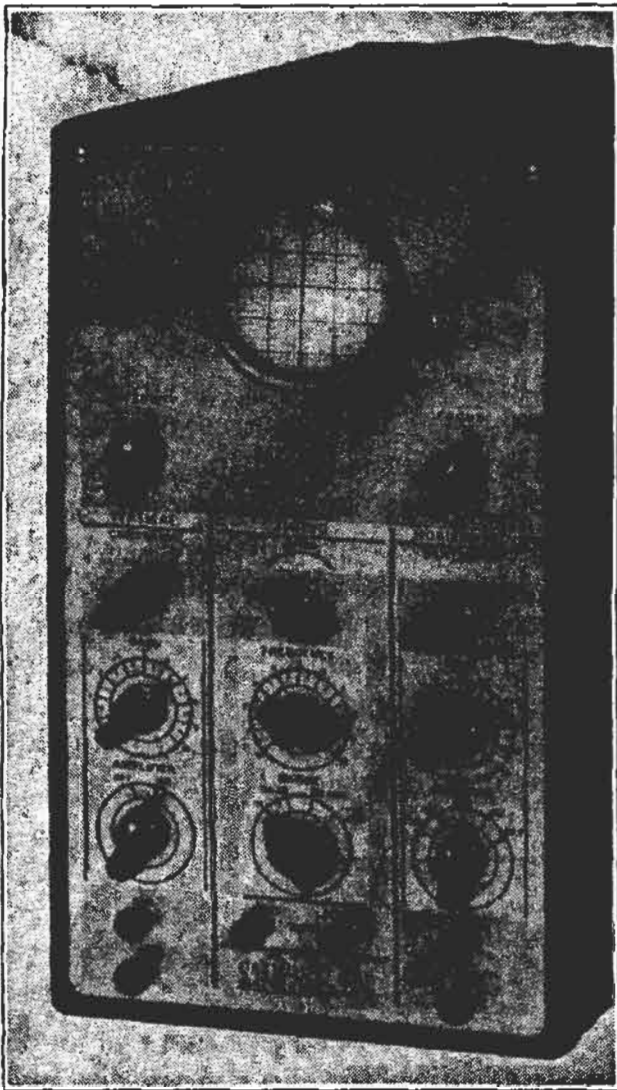

Courtesy HUA

FIG. 9. The controls on the RCA 155 oscilloscope—a typical service type instrument.

just the *FREQUENCY* control (R_{12}) in the *TIMING* group, so that the sweep frequency will be the same as that of the wave on the vertical plates. This is accomplished by turning the control until the pattern on the screen stands still, instead of moving about in a scramble. Several "stationary" points will be found within the range of the control, and the one should be chosen which gives on the screen a single complete cycle of the sine wave. The sweep circuit is now set to 60 cycles, and "locked" with the incoming wave.

The *VERTICAL GAIN* control will now vary the amplitude (height) of the sine wave, while the *HORIZONTAL GAIN* control will vary the

width of the image. These two controls should be adjusted so that the image is well within the dimensions of the screen of the cathode ray tube.

It now may be necessary to readjust the *SYNC* control until the image stands still. (It may still get out of step momentarily, causing the image to "jump" occasionally.) Use the least amount of *SYNC* voltage (knob turned farthest toward the left) which will give a stationary image, as too high a setting can distort the image by causing a non-linear sweep.

DISTORTION PRODUCED BY THE CONTROLS

Image distortion may occur if the signal amplitude is so increased that the image extends out near the edge of the screen. Since only a portion of the screen can be made useful without distortion, a large size screen is desirable, to permit a large image which does not reach the edge of the screen. Service oscilloscopes usually have screens of 3 to 5 inches in diameter. The 3-inch tube limits the useful image to about 2 inches in each direction.

Fig. 10 shows how the proportions between the horizontal sweep and ver-

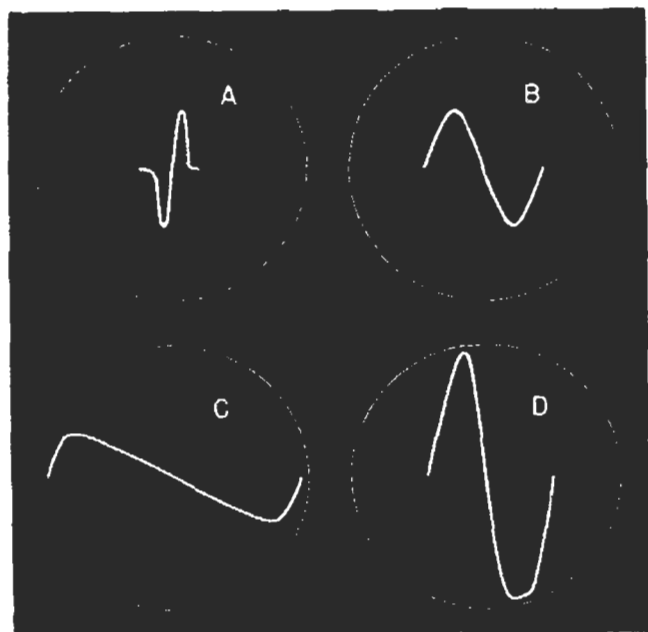

FIG. 10. Improper adjustment of the controls can distort the produced image as shown here.

tical amplitude affect the usefulness of the image. In 10A the sweep is turned too low; the horizontal gain control should be advanced to "pull out" the image lengthwise, to avoid the too-sharp peaks. In 10C, the image has been stretched too far, and in 10D it has been increased in height too much, producing a square shape at the bottom (distortion). Proper adjustment of horizontal and vertical gain controls produces the well proportioned image of 10B.

STRAY VOLTAGES

Stray voltages, in addition to those being studied, may be picked up by the c.r.o. and appear on the screen. Strays are most apt to be picked up in the neighborhood of industrial machinery, and when test leads are connected

to the vertical input terminals but are not connected to any source of voltage. Under these conditions, a straight vertical line will appear on the screen with no horizontal voltage applied. Should the sweep be on, you can even synchronize with a distorted pattern, particularly when the stray voltage is from a near-by power line.

If the test leads are touched together or connected to a source of voltage, the stray voltage will usually be minimized. If, however, the stray is very strong, it may come through even with the leads connected to a voltage source, and will appear as a series of humps that "crawl" around the stationary pattern. The only cure for this is to shield the test leads or move the instrument to another location.

Putting the C.R.O. to Work

So far, we have learned how the c.r.o. operates, and how to make it reproduce an image of the applied a.c. voltage. In order to show how this instrument is used on the service bench, we are now going to take up the actual methods of applying it to service problems, such as determining frequency, signal tracing, finding hum, oscillation or distortion, and determining phase relationships. Then we will show how high-fidelity alignment depends on this instrument. The c.r.o. is literally an instrument of a thousand uses, but the ones to be described here are those which the advanced serviceman is most likely to find of the greatest value in speeding up his work and making it accurate, efficient and professional.

FREQUENCY DETERMINATION

In the c.r.o. operations already described, we have obtained a stationary image of a single cycle on the screen by

adjusting the sweep frequency to be exactly equal to the incoming frequency. Actually, a stationary pattern will be obtained if the sweep is a sub-

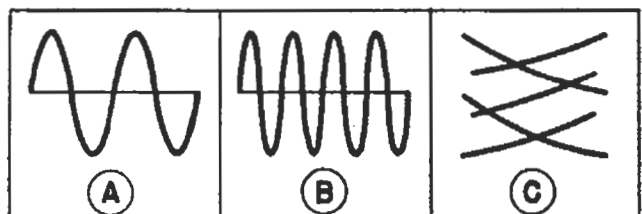

FIG. 11. Frequency can be determined by the number of cycles or lines in the pattern.

multiple of the incoming frequency, and the number of complete cycles in such a pattern immediately gives the relationship of the two. For example, if the incoming wave is 1000 cycles and the sweep is set to 500, we will get a 2-cycle pattern, as shown in Fig. 11A. Two cycles of the incoming wave occur during each sweep cycle. Similarly, a wave having a frequency four times

the sweep frequency makes four complete cycles, and so on up to 15 or 20, depending on the size of the screen.

► When the sweep is adjusted the other way, so it is *above* the incoming signal frequency, we no longer get an image of the incoming signal. Instead, there will be a series of more or less horizontal lines. When adjusted so that there are two lines stationary, the sweep frequency is twice the incoming signal. When there are three lines, the sweep is 3 times this frequency, etc. Fig. 11C shows five lines, so the sweep is five times the incoming signal. These patterns can be used only for frequency determination.

► In between these points where the sweep voltage and incoming frequency lock to produce a steady image, you will get various scrambled patterns. As these scrambled patterns are continually changing, they cannot be analyzed.

► The fact that we can get a number of patterns which do lock permits us to calibrate the sweep generator controls approximately, if an accurate signal can be fed to the vertical amplifier. Then, by making a chart of the setting of the sweep controls, we can use the settings as rough frequency determinants for unknown incoming signals.

For example, if we apply an accurate 1000-cycle signal and then adjust the sweep circuit to get a single sine wave, we have the sweep circuit set for 1000 cycles. When we adjust to where we get two sine waves, the sweep is set at 500 cycles, etc. Thus, by using one frequency we can find perhaps 10 or 15 points on the sweep controls accurately.

When an unknown signal is applied, we can estimate the frequency from the adjusting points on the frequency controls. Of course, this is not an extremely accurate method of determin-

ing frequencies, as the sweep frequency drifts, but it may prove entirely good enough for many purposes.

DETERMINING FREQUENCY BY USING LISSAJOUS FIGURES

If we apply a.c. voltages to both sets of plates, instead of a.c. to the vertical and a saw-tooth to the horizontal, a type of pattern known as a Lissajous figure is obtained which can also be used for frequency determination.

If exactly the same a.c. voltage is applied to both pairs of deflecting plates *in phase*, a straight slanting line is obtained, as you will recall from Fig. 5. Should the voltages be of the

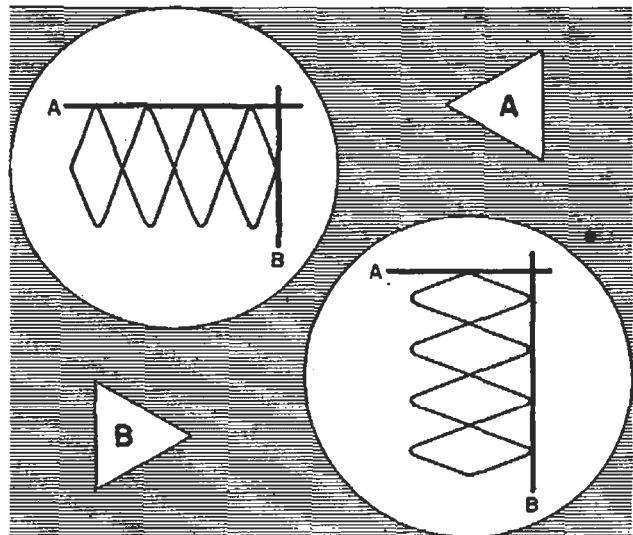

FIG. 12. Using imaginary lines A and B to determine frequency in a Lissajous figure.

same frequency, but out of phase, as may occur if they are from different sources, then a loop or circle will form. However, any pattern which is a single line, oval or circle shows that the two a.c. voltages have the same frequency. A series of closed loops means that the two frequencies differ, and the position and number of the loops gives the ratio of the two applied frequencies. Even fractional ratios can be determined in this way.

For example, suppose we find that we get the pattern shown in Fig. 12A. To determine the frequency ratio,

draw or imagine the lines *A* and *B*. Notice the number of times each line is touched by the image. The line *A* is touched four times, while the line *B* is touched once. Therefore, the frequency ratio is 4 to 1 and the frequency of the signal applied to the vertical plates is 4 times that of the signal on the horizontal plates in this case. Thus, if a 60-cycle voltage is applied to the horizontal plates, the vertical plate voltage has a frequency of 240 cycles.

It is possible for the image to turn around, as shown in Fig. 12*B*. Now the figure touches the line *A* once and the line *B* four times, so the ratio is now 1 to 4 and the horizontal signal frequency is 4 times the vertical signal

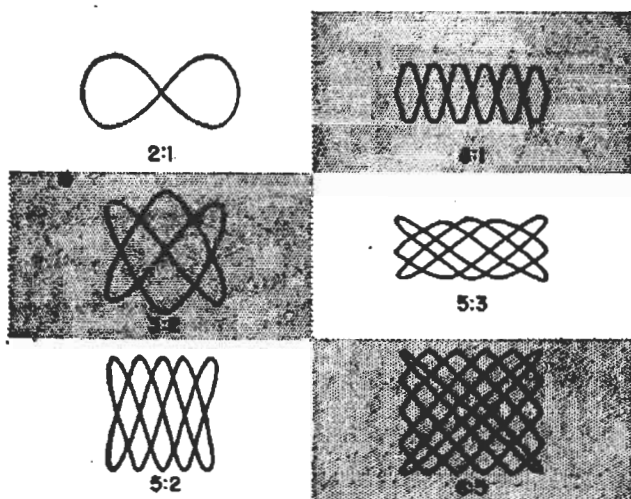

FIG. 13. Several typical Lissajous figures showing frequency ratios.

frequency. Thus, if the horizontal voltage is still a 60-cycle signal, the vertical voltage must be a 15-cycle signal.

A number of typical patterns are shown in Fig. 13. In all cases, counting the number of times the loops touch the imaginary lines *A* and *B* will give the frequency ratios.

Notice that Fig. 13 shows some of the fractional patterns for ratios such as 3 to 2, 5 to 3, etc. Should these patterns be turned around, the opposite ratios are indicated, such as 2 to 3, 3 to 5, etc. Using 60 cycles as the hori-

zontal voltage, a 5 to 3 ratio gives $5/3 \times 60$, or 100 cycles as the vertical frequency, etc.

By carefully studying the patterns, with one a.c. voltage from a source of known frequency, the frequency of the unknown a.c. wave can be determined.

PATTERN PECULIARITIES

Certain peculiar patterns become intelligible when the controls on the c.r.o. are adjusted. A good example of this is a case where the rapidity of movement of the spot at certain portions in the pattern makes those parts invisible until the intensity is brought up. The disappearance of the back trace in Fig. 7 is an example of this. In Fig. 14*A*, a disconnected pattern is shown which becomes Fig. 14*B* when the pattern is made brighter. The motion of the spot from *a* to *b*, from *c* to *d*, from *e* to *f* and *f* to *a* is so rapid that no line may be visible at low intensities. Square waves in general will have very thin vertical lines, since the spot moves very rapidly in such patterns.

Other examples are shown in Figs. 14*C* and 14*D*, with the faint lines being shown here as dotted lines.

SIGNAL TRACING

When signal tracing in dead receivers with a c.r.o., a signal generator is connected to the input of the receiver, and the c.r.o. vertical input is connected across the plate circuit of each stage in turn, working toward the output. The sweep can be set so that the image has some recognizable character, giving positive identification of the signal, and we can tell how far the signal gets through the receiver. Of course, the same can be done by using the signal generator and the receiver loudspeaker and working in the other direction—from output to input, so the c.r.o. is not a requirement in this case.

In the case of hum, noise, oscillation

or distortion, the c.r.o. is more valuable, as you can not only find the source of trouble—the wave shape gives a clue as to the exact nature of the trouble.

Hum. By setting the sweep to 60 cycles and moving the vertical input connections along from the second detector to the output, the presence and *exact location* of hum voltage is determined. Hum picked up from the wiring or due to cathode-to-heater leakage is 60-cycle hum and shows a single-cycle pattern. However, hum caused by defective filter condensers in a full-wave power supply is 120 cycles and would give a 2-cycle pattern. Of course, you would normally check filter condensers and for cathode-to-heater leakage before using the c.r.o. Then the c.r.o. can be used for those unusual cases where the hum arises in an audio stage.

Noise. A signal generator connected to the input may or may not be necessary to find noise, depending on whether the noise source requires a shock to produce it. Most noises arise in circuits carrying d.c. and are caused by electrolysis producing corrosion, which in turn causes a poor contact. These noises can be heard and found without a signal. Any noise occurring in a signal circuit, or which is dependent on a signal, requires the use of a signal for quickest location.

When viewing a signal pattern, an added noise voltage causes irregular tearing and breaks in the pattern, with high, sharp peaks. Thus, by moving along from the radio input toward the output, when you reach the stage in which the noise is produced a jagged signal with irregular peaks will appear, either added to the steady signal or as a separate pattern, if a generator is not being used.

Oscillations. Oscillation is also found by moving the vertical input

leads from stage to stage in the receiver. Oscillations may occur in either the r.f. or the a.f. sections. No signal source is necessary to localize the trouble.

An exception is an audio amplifier which has a response peak, so it favors strongly some particular frequency. This amplifier may not oscillate until a signal at or near the resonant frequency is fed to it; the signal can then usually be turned off. Using a variable frequency audio oscillator, the signal frequency can be varied until oscillations start, then steps can be taken to damp this oscillation, once the offend-

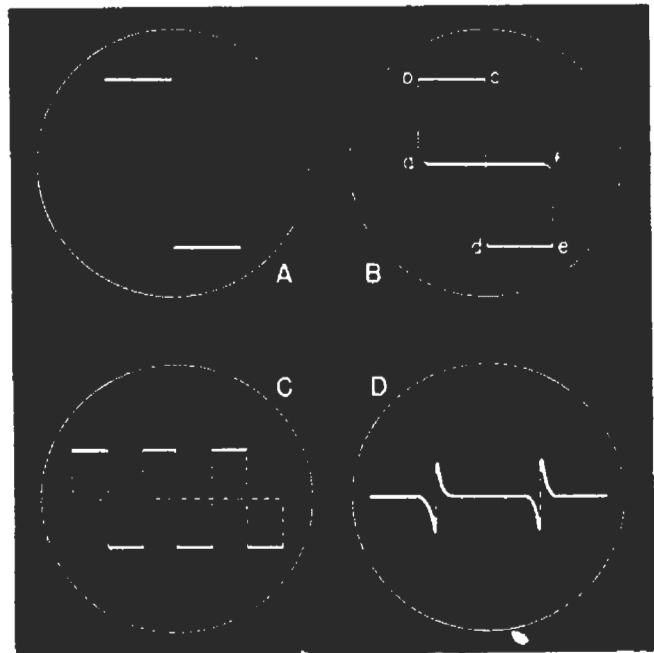

FIG. 14. Bring up the intensity enough to see the complete pattern so you won't be puzzled by disjointed images.

ing stage is discovered. When the signal generator is being used, the oscillation will appear as an interference to the generator pattern, or a sharp increase in image size.

Distortion. The c.r.o. is particularly useful for distortion complaints. Proper interpretation of the patterns seen will give a valuable clue as to just what is wrong with the amplifier.

Before beginning a search for distortion, it is necessary to understand that we are not going to try, in radio servic-

ing, to create perfect audio amplifiers. All amplifiers have a certain amount of distortion, and the human ear, in addition, is an imperfect instrument. A receiver which sounds good to one person may sound poor to another.

Thus, to the radio serviceman, distortion is any condition which makes a receiver sound worse than it normally does. It is only when something has happened to the receiver that a serviceman is likely to get a call.

Of the three types, amplitude, frequency and phase distortion, the radio serviceman is most interested in the first, since serious amplitude distortion is very offensive to the ear. Ordinary amounts of phase distortion cannot be heard at all and any defect producing a remarkable amount of frequency distortion will normally cause weak reception or hum also, which is easily located by other means. A television serviceman, on the other hand, is equally as interested in phase distortion because of its great effect on the picture. With these facts in mind, we can proceed to describe exactly how the c.r.o. is used to locate the different forms of distortion.

AMPLITUDE DISTORTION

With amplitude distortion, the shape of the wave is altered by the addition, in the amplifier, of harmonics that were not in the original signal.

Therefore, we can determine the amount of amplifier distortion by comparing the shape of the wave that goes into the amplifier with that which comes out of it. We can also determine the location of the distortion by moving along stage by stage to determine just where the wave shape changes.

A signal must be sent through the audio amplifier by an audio oscillator or the audio modulating tone from a service generator. The c.r.o. vertical input is connected across the generator

and the sweep adjusted until a stationary pattern of 1 to 3 cycles is obtained. The input should be a constant sine wave frequency, for easy comparison.

By connecting the c.r.o. as shown in Fig. 15, we can quickly shift the c.r.o. signal from that at the input to that at the output of the amplifier. The wave shape at the output can then be compared with that at the input, and any change, indicating distortion, will be apparent.

Because it may be difficult to remember accurately the input wave shape when the output appears on the screen, and due to the increase in amplitude of the output, it is convenient

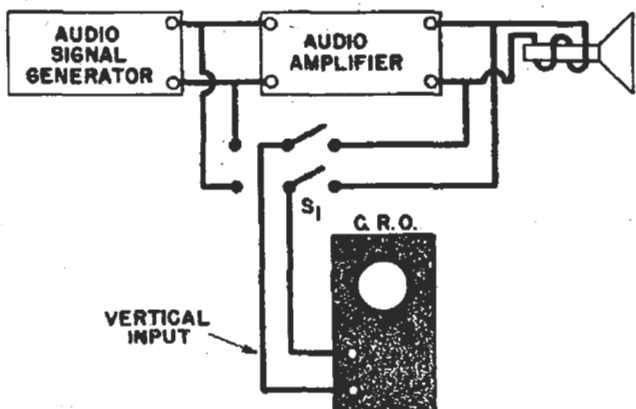

FIG. 15. How to connect the c.r.o. to an audio amplifier when checking for distortion.

to put a piece of tracing paper over the screen and trace the input wave form on it. This is easily compared with the output wave form, when the gain is adjusted so the tracing and output signal have the same amplitude (size).

Very small amounts of amplitude distortion cannot be determined by study of a sine wave. However, as pointed out, in radio servicing only rather large amounts of amplitude distortion will cause complaints, and such quantities are detectable on the c.r.o. screen.

CAUTION. When making the tracing, be careful not to punch or strike the end of the c.r.o. tube. These tubes are vacuum types and, due to their

size, are under terrific pressure. A scratch or puncture will cause an "implosion" (air rushing inward) which shatters the tube, blowing glass slivers about with great force.

Most modern c.r.o. units have a celluloid or plastic shield over the tube face for protection. This shield will be marked with convenient vertical and horizontal guide lines or scales, so the size of an image can be easily compared with another. There is no great danger when making a tracing over this shield.

► The oscilloscope has two important advantages in distortion complaints.

wave, but the lower section has been distorted. This immediately indicates that the tube in the stage in question is operating over a curved region of its characteristic. One-half the applied voltage is amplified normally but the other half is being cut off because of the operation over the curved tube characteristic. We cannot know whether this is the upper or lower tube characteristic, however, unless we know the direction of deflection of our c.r.o.

Determining the Direction of Deflection. The direction of deflection can be determined by using a battery. Turn off the horizontal amplifier, leaving a spot (or line if strays are picked up) of light on the screen,

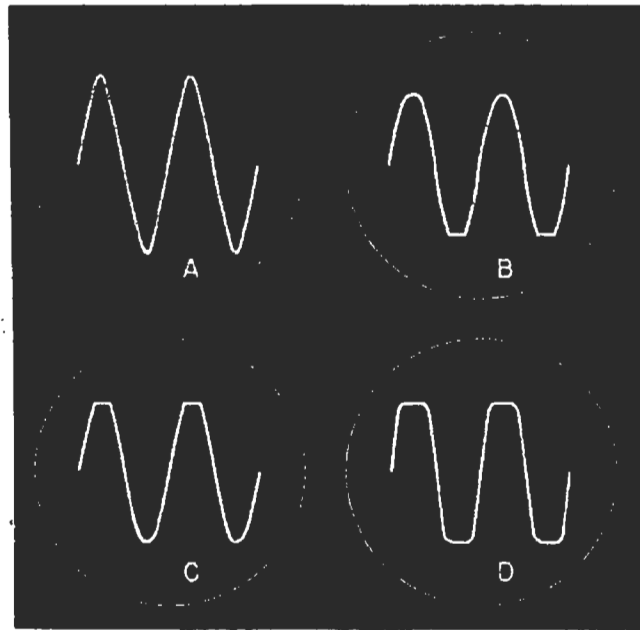

FIG. 16. Basic distortion patterns.

By moving the c.r.o. stage by stage through the receiver, the exact location of the distortion can be found. In addition, the shape of the distorted wave will often indicate the cause of the trouble.

For example, suppose we start with the sine wave shown in Fig. 16A. This should pass through the amplifier with no change other than an increase in amplitude. However, suppose that some stage produces a wave like that in Fig. 16B. As you will notice, the upper portion of the wave is still a sine

turn up the vertical amplifier, and touch the vertical test leads to a battery. The spot or line will jump up or down, returning slowly to its original position. The spot jumps because the battery causes a momentary charging current through the input blocking condenser, which is passed on like an a.c. signal.

After touching the battery, discharge the blocking condenser by touching the test leads together. Reverse the battery, and the spot should jump in the opposite direction.

The direction of movement of the spot depends on the number of stages in the c.r.o. amplifier and on the tube connections. Notice the battery polarity which causes the spot to jump up. Should the hot (or "high" lead on the RCA 155) lead go to the *negative* bat-

tery terminal, the c.r.o. has a negative input polarity; otherwise, a positive input polarity.

Causes of Distortion. If the signal shown in Fig. 16B is obtained right across the plate load in the plate circuit of the stage causing the distortion, it indicates that we have too much bias, too low a plate voltage or a weak tube, when the oscilloscope has a negative input polarity. Either condi-

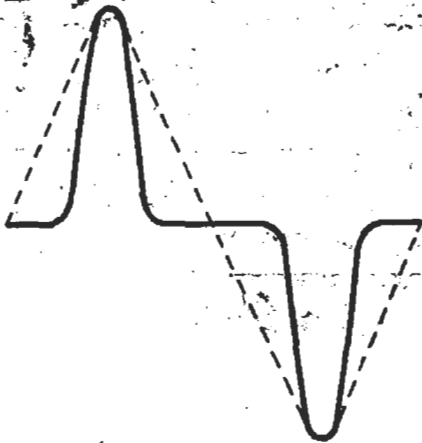

The solid line shows the wave form obtained when a push-pull stage is over-biased. Compare with the dotted sine wave.

tion causes a tube to operate over the lower curved portion of its characteristic.

If the signal is inverted, as at C, so the top half is distorted while the lower half is normal, then under the same input negative polarity condition, this would indicate that we are operating near the upper bend in the tube characteristic. A logical cause for this would be a lack of sufficient bias. In either case, look for the usual causes of these operating voltage changes and you will go right to the source of trouble.

► Should the oscilloscope have a positive input polarity, the exact opposite conclusions are to be reached in these two cases.

► We can reach these particular conclusions about the causes of the distortion of this wave only if we are in the plate circuit of the offending stage. If we get the distorted wave shape at the

output of an amplifier, you must remember that each stage is inverting the signal 180° , so the wave is inverted, once for each stage it passes through. Hence, if we connect to the output of an amplifier and get this kind of wave, we know only that some tube is operating over a curved characteristic and we must localize the distortion further.

► The wave shown in Fig. 16D has both halves distorted or chopped off. This at once is a sign of an overloaded audio stage. Either the signal fed to the stage is too high, or something within the stage is causing the tube characteristic to curve excessively, so that very little of the straight portion

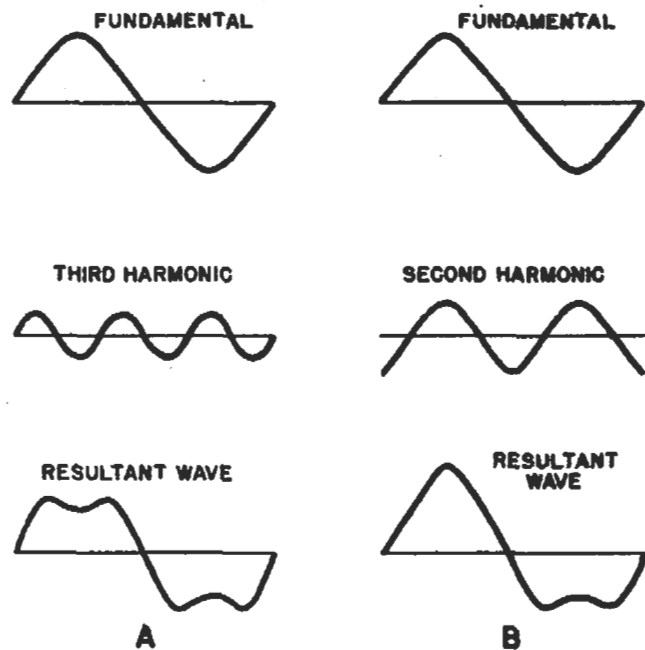

FIG. 17. Adding harmonics to a fundamental produces a wave shape change. Notice the difference between the resultant for odd harmonics and that for even harmonics.

is left. This condition is commonly the result of a poor tube, or lower than normal plate voltage, accompanied by a drop in bias voltage.

Even and Odd Harmonics. In studying such distorted sine waves to determine the source of the distortion, it is useful in addition to know whether the added harmonics are even or odd

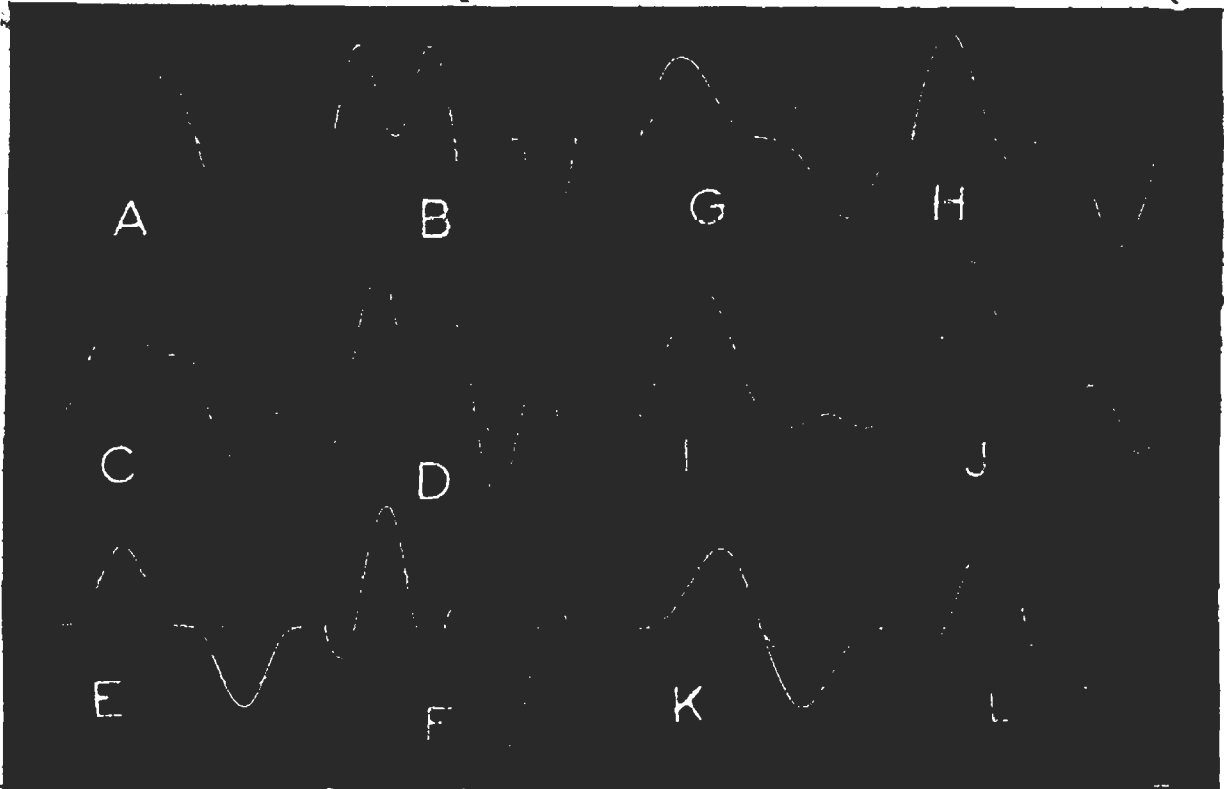

FIG. 18. Fundamental, harmonic and resultant waves superimposed on each other. The patterns A through F show odd harmonics, while G through L show even harmonics. The shape of the resultant depends on the amplitude and phase of the harmonics. Thus, A, B, G and H show harmonics in phase; C, D, I and J show a 90° phase shift between fundamental and harmonics; E, F, K and L show a 180° phase shift. Patterns A, C and E show the harmonic one-third the amplitude of the fundamental, while B, D and F show equal amplitudes. Similarly, G, I and K show harmonics with one-half the fundamental amplitude, and H, J and L show equal amplitudes. Regardless of the phase or amplitude, odd harmonics produce symmetrical resultants while even harmonics produce unsymmetrical waves.

harmonics, since this is often a further clue to the source of the trouble. Figs. 16B and 16C represent *even* harmonic distortion, because they result from the addition of the second, fourth, sixth or higher harmonics to the original sine wave. The wave shown in Fig. 16D, on the other hand, represents *odd harmonic* distortion, as it is primarily the result of combining a fundamental with the third, fifth and other odd harmonics.

Harmonic Combinations. Figs. 17 and 18 show graphically how various types of harmonics, of various amplitudes and phases, combine with a fundamental to make a complex wave. You will note that adding *odd* harmonics to a sine wave produces a *symmetrical* wave, that is, both halves of the cycle are exactly the same shape.

The lower half could be flipped up and would fit over the upper half.

On the other hand, when even harmonics are combined with the fundamental, the two halves of the waves are not symmetrical (not exactly alike). Of course, the actual shape of the wave will depend on the phase relationship and the relative amplitudes between the voltages, as shown in Fig. 18. Incidentally, when looking at some of the even harmonic waves of Fig. 18, you will find that the halves of the resultant waves are *mirror images*, that is, the lower half, if flipped up, would be a complete *reversal* of the upper half.

► Of course, it is perfectly possible to have a combination of even and odd harmonics at the same time. Then the resulting shape of the wave will de-

pend on the relative amplitudes and phases of the harmonics.

► As a bit of extra information, *even harmonic* distortion is not as noticeable to the human ear as is *odd harmonic* distortion. The even harmonic distortion may be as high as 10% before it is readily noticed, while odd harmonic distortion of 3% to 5% is usually noticeable.

FREQUENCY DISTORTION

Frequency distortion, the inability of the amplifier to amplify equally all frequencies in its operating range, is usually detected by sending sine waves of different frequencies but constant amplitude through the amplifier. The output is measured at each frequency, and a comparison of the outputs at different frequencies to a reference frequency output, usually by means of a curve, will show whether or not the amplifier is "flat" enough for the purpose for which it was designed. Fig. 19 shows a typical curve. Notice that the output is measured, as no change in the wave shape occurs, other than its size.

► Developing a response curve by

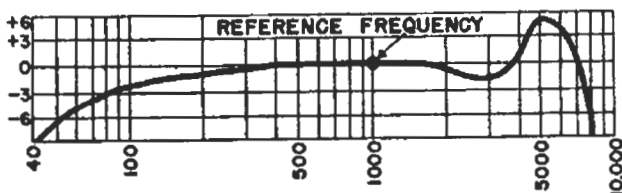

FIG. 19. A typical frequency response curve.

measuring output on a c.r.o. would be rather tedious, so it is usually not done in this way. A method of developing the response curve of the amplifier on the screen of the c.r.o. in a single pattern will be described later.

► Few defects in an amplifier change the frequency response without producing other changes in operation. An open coupling condenser would reduce the response to low frequencies, but would also result in an over-all lower-

ing of volume. A defective output filter condenser will affect the frequency response but will also introduce hum. A saturated transformer core reduces low-frequency response and will cause low volume as an additional symptom. A change in the characteristics of the loudspeaker is about the only defect which will produce frequency distortion without some accompanying symptoms leading you directly to the defect.

PHASE DISTORTION

Phase distortion is a shifting of the phase relationships between various frequencies, in passing through an amplifier. Voltage peaks of different frequencies do not emerge with the same

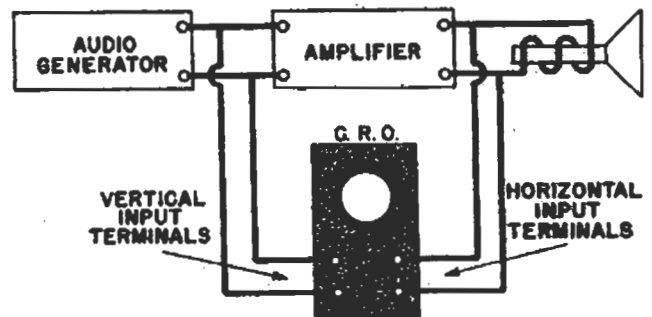

FIG. 20. The c.r.o. is shown connected here for determining phase shift.

time relationship they started with, so some peaks occur earlier or later than normal. This distortion is usually the result of some condenser-resistor combination, which delays or slows down the passage of some frequencies more than others. The extreme high and low frequencies are particularly affected this way.

For ordinary music, phase distortion is of relatively little importance. The ear cannot detect phase shifts unless these shifts become large with respect to the time taken by a musical note. The amplifier will tend to cut off the signal altogether before any such large phase shift can occur.

However, in television, phase shifts

are extremely important. The c.r.o. provides a ready means of measuring phase shift in an amplifier, and the television serviceman must understand thoroughly how to perform this measurement.

► The connections are shown in Fig. 20. The vertical amplifier is connected to the signal coming from the audio signal generator. Then, the horizontal amplifier input is connected to the output of the amplifier, instead of to the timing circuit.

If there is no phase shift, we should have the same signal at the output as we had at the input, so this is like feeding the same a.c. signal to both sets of deflection plates. As you will recall, this will produce a slanting line. However, remember that the line is produced only if the voltages applied to the two sets of plates are completely

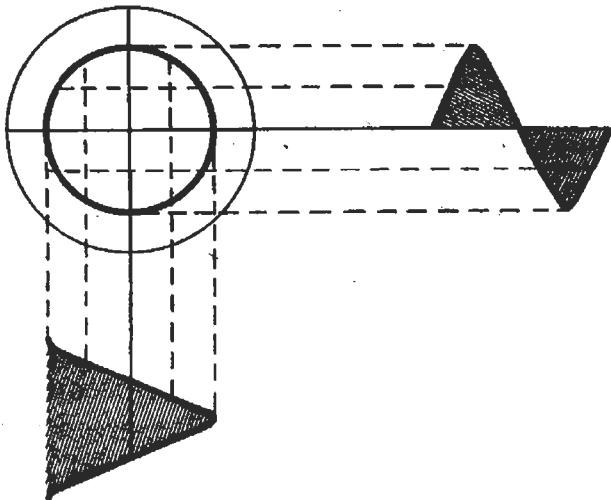

FIG. 21. Applying sine waves 90° out of phase to the c.r.o. produces a circular pattern.

in "step" or phase. Should there be a difference in phase, other patterns will be produced.

For example, if the voltages are equal, but are 90° out of phase, we will get a perfect circle as shown in Fig. 21. The two applied voltages are 90° out of phase as shown here, because one is at its maximum point while the other one is at zero.

Several typical patterns are shown

in Fig. 22 for different phase shift conditions. Notice that the pattern changes gradually from the slanting line through an ellipse to the circular pattern, then goes back to a slanting line pattern, tilted in the opposite direction.

► Of course, the exact shape of these patterns will depend upon the relative amplitude of the voltages. Usually, the amplitudes are adjusted to be ap-

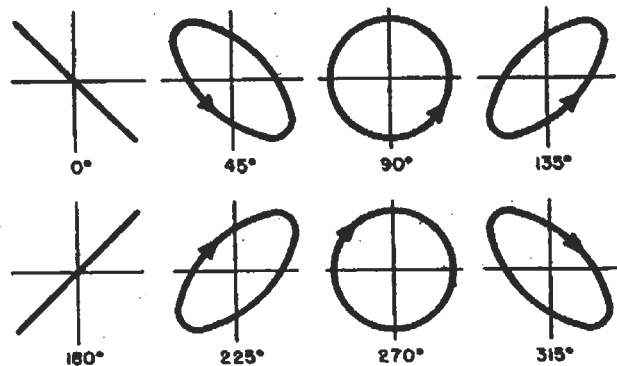

FIG. 22. The pattern changes from a slanting line to an oval, then to a circle, as the phase difference is changed.

proximately the same. To do this, turn off the vertical gain and adjust the horizontal gain to produce a line of some reasonable length, noting the horizontal gain control setting. This line is then measured. The horizontal gain is now turned off and the vertical gain turned up until a vertical line of the same length is formed. Then, the horizontal gain control is reset to the position which gave our first line.

When the figure is formed, its shape will indicate the phase difference. The pattern will form around the point where the horizontal and vertical scale lines on the screen of the tube cross, if the spot was originally centered at this point. Usually, we are interested only in finding whether a phase shift has occurred and are satisfied with a very rough approximation of the amount, as can be determined by comparison of the size and tilt of the oval patterns.

Should the exact value be necessary then we must use trigonometry. This method permits determining the phase angle, even when the amplitudes are not exactly equal. Measure the distance along the vertical line, represented by B of Fig. 23 and also the amplitude of the ellipse, which is A . Divide B by A and the result will be a number which is the sine of the phase angle. Then, by looking up this value in a trigonometric table, we can find the angle. For example, suppose we find that B is equal to $\frac{1}{2}$ inch, while A is equal to 1 inch. Then, dividing $\frac{1}{2}$ by 1, we get .5. A sine table shows this to be the sine of 30° , 120° , 210° and 300° . If the 0° line tilts as shown in Fig. 22, by looking at the direction of tilt of the oval, we can tell whether we have: a , 30° or 300° , or b , 120° or 210° . (The tilt will be similar to the 4t

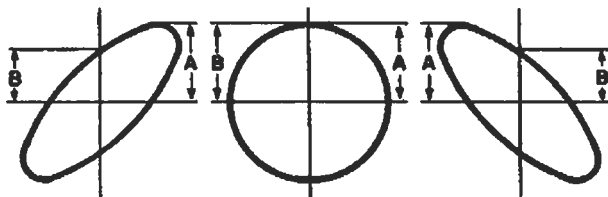
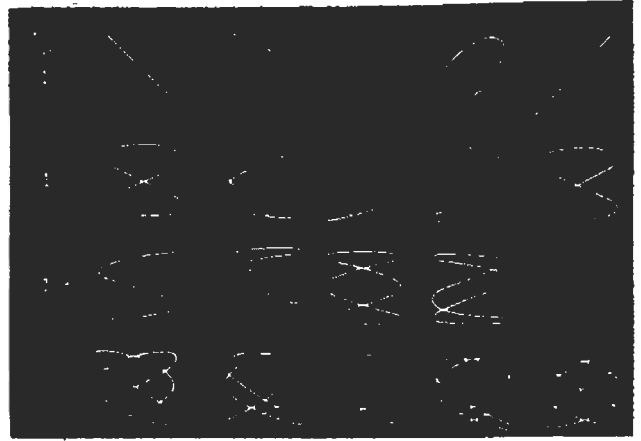

FIG. 23. Measure A and B to determine the phase shift.

and 315° , or 135° and 225° degree ovals shown in Fig. 22.) We cannot determine which one of group a or b it is, unless the direction of rotation of the spot can be determined, or we can increase the phase shift by a special circuit. Then, if the pattern becomes circular, we have either 30° or 210° , while if it changes to a line, we have either 120° or 300° . Thus a tilt to the left (as the 45° pattern in Fig. 22) which changes to a circle as the shift is increased indicates a 30° pattern.

The phase shift patterns shown in Fig. 22 depend on the actual connec-



The Lissajous figures we studied earlier are affected by phase shifts as shown here. The vertical columns from left to right show phase shifts of 0° , 45° , 90° , 135° and 180° . The patterns will drift from one form to another if the frequencies do not have exactly the ratios indicated. Hence, you can let the pattern drift to a shape where the ratio is easily found rather than worry about some of the intermediate forms.

tion of the plates of the c.r.o. tube. It is possible for the tube to be rotated itself 90° or for the plates to be connected differently. If so, the patterns will be interchanged. The pattern we have shown for 180° will be the zero pattern while the zero pattern will be that for 180° . Similarly, the other patterns will interchange, the 45° pattern becoming then the pattern for the 225° and vice versa. The only way you can determine which is the true zero for your particular oscilloscope is to connect the same voltage, from the same source, to both the vertical and horizontal plates and notice in which direction the line slants.

High-Fidelity Alignment

The c.r.o. finds one of its most important service applications in the alignment of high-fidelity receivers. The problem of alignment of such receivers is entirely different from that of the ordinary receiver, which requires only a standard signal generator and an output meter.

If the i.f. amplifier of a high-fidelity receiver is adjusted for maximum response at a single frequency, the band-pass characteristic will be destroyed and the receiver will lose the "fidelity" which it was designed to have.

The necessity for a band-pass i.f. in a high-fidelity receiver is plain if we remember that a modulated carrier consists of a *group* of frequencies, which extend *above and below* the carrier as far as the highest frequency to be transmitted. Thus, a 5000-cycle modulation range requires a band of frequencies 10-kc. wide, and this is the usual broadcast practice, entirely adequate for voice or dance music. Many stations now modulate to 7500 cycles, however, and some special ones go even higher. Such higher frequencies are necessary for true fidelity with fine music.

Receivers designed for distant reception cannot pass a band 15 kc. or 20 kc. wide which is necessary for high fidelity. Fig. 24A shows how such receivers are designed for a much sharper response, in order to eliminate interference between stations only 10 kc. apart in the broadcast band. Naturally, when frequencies only 5 kc. from the carrier are so sharply "cut" as shown in Fig. 24A, the high-frequency modulation will be practically eliminated and the receiver will heavily emphasize the bass frequencies. This may suit some "ears," but is not true fidelity.

In order to get the higher side band frequencies through the i.f. amplifier, high-fidelity receivers have the "flat-top" band-pass characteristic shown in Fig. 24B. This can be made wide enough to pass 5000 cycles without attenuation, as shown in Fig. 24B, or may be made even wider to obtain higher fidelity. Naturally, such receivers can be used on strong local signals only, since their wide response would permit serious interference from distant stations, if the sensitivity were also high.

► To align a band-pass circuit properly, we must adjust the response so that it is even over the whole width

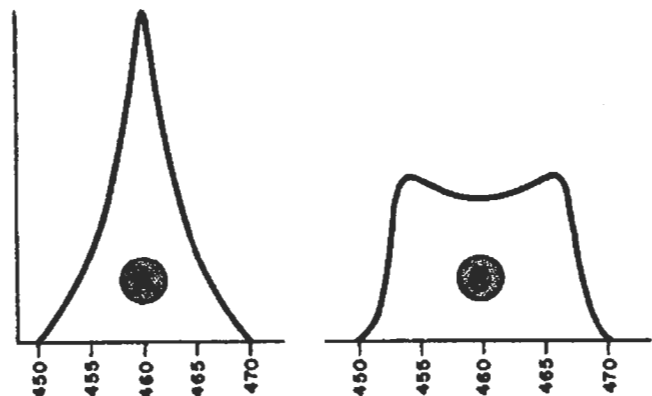

FIG. 24. Resonance curves. A shows a high-selectivity, high-sensitivity response, while B shows a broad pass-band for better fidelity.

of the pass band, and not "peaked" at one frequency, as in an ordinary i.f. circuit. This could be done by feeding different frequencies throughout the pass band into the amplifier, and plotting the various output levels as a response curve. This is a tedious process, however, and would have to be repeated each time the circuits were adjusted.

With the c.r.o., the response over the whole pass band can be made instantly visible on the screen, and the effect of adjustments will be apparent as they are made.

This is done by changing the frequency of the generator signal back and forth over the pass band at a regular rate, and at the same time applying a horizontal sweep on the c.r.o. which carries the spot across the screen and back at the same rate. If the input level is held constant, the *vertical* height of the spot above the center line will be proportional to the signal

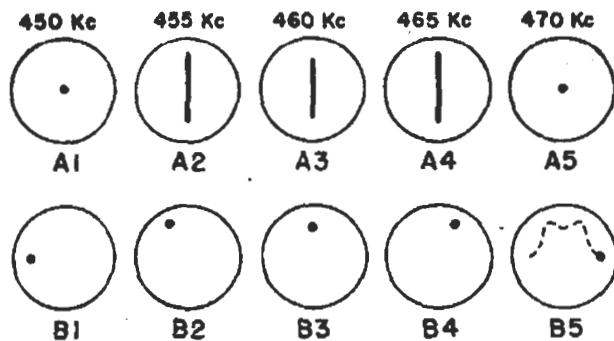

FIG. 25. The application of voltage to the vertical plates only will produce lines of varying length as in A1 to A5. By sweeping the spot as in B1 to B5, we get a trace of the wave as shown by the dotted line in B5.

output, and since the spot is also moving *horizontally* in step with the changing carrier frequency, it will plot a graph of the amplifier response over the band covered. Fig. 25B shows the spot at different positions in the sweep and in B5 indicates the curve that is formed.

► To use this system, we must vary the generator frequency over a wide band at a steady, rapid rate, and synchronize the c.r.o. horizontal sweep with these variations, to make the curve stand still. This is obviously impossible to do by hand, but there are two means of doing it, one mechanical and one electrical. Both systems, which use special signal generators known as "wobblers," use a variation rate of 40 to 60 times a second, and sweep the signal frequency over a band 20 or 30 kc. wide. As this is frequency modulation, such generators are also called f.m. signal generators. Both systems will be described.

MECHANICAL WOBULATION

Mechanical wobulation is obtained by placing a small variable condenser in parallel with the regular tuning condenser of the oscillator tank circuit, and driving this small condenser by means of a motor. The condenser is made so it rotates through a complete circle, its capacity going from maximum to minimum and back, once for each rotation. This carries the signal frequency up and back again in step with the rotation.

For example, suppose the oscillator is set at 1400 kilocycles and the trimmer, such as the one shown in Fig. 26, is being rotated. The circuit is set for normal frequency when this condenser is half in mesh, as shown at C. Then the motor is started, which rotates the condenser through its range 30 or 40 times per second. As it changes from maximum to minimum capacity, this signal frequency goes

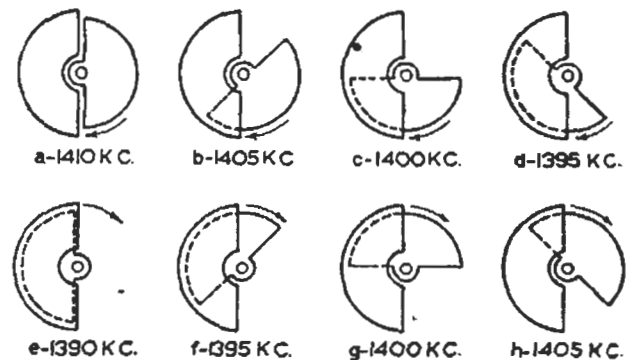

FIG. 26. Rotating the trimmer produces a frequency change with the change in capacity.

through a range of about 20 kilocycles, 10 kilocycles on each side of the normal or resting frequency.

As this condenser has a certain fixed capacity change, it will give a different band width as the main tuning condenser is adjusted for a different resting frequency, because this changes the ratio of the capacity *change* to the total capacity. As a fixed band width is desired, standard practice is to make use of a fixed oscillator. A frequency

of 700 or 800 kilocycles may be used by some manufacturers, while others may use 2000 kilocycles. In any event, the motor-driven condenser varies the frequency of the fixed-frequency oscillator, so the band width is fixed. Then, the output of this fixed-frequency oscillator is mixed with the output of a variable-frequency oscillator in a mixer-detector circuit. The resulting beat frequency is the output, so the resting frequency can be varied at will, but it is swept over a fixed band width. The dial on the signal generator is calibrated in terms of the frequency which actually comes out of it as a result of this mixing process.

Obtaining Synchronization. Various means of synchronizing the c.r.o. horizontal sweep with the rotations of the condenser can be used. A magnet on the condenser motor shaft,

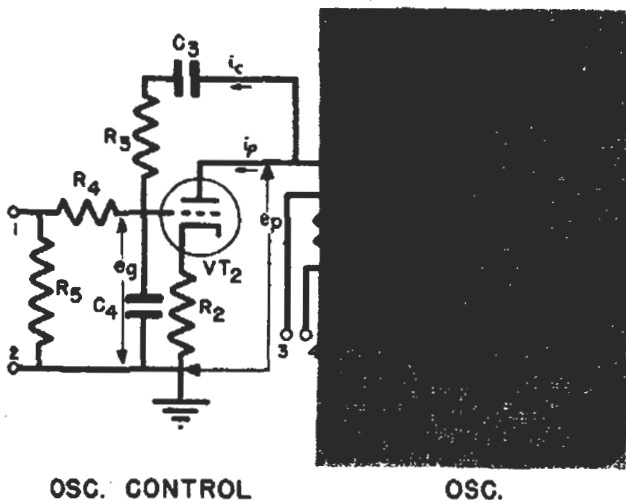

FIG. 27. The oscillator control circuit for electronic sweeping is just like the control circuit used in a.f.c. systems.

turning near a fixed pickup coil, will give a regular pulse for each rotation. The magnet can be shifted on the condenser shaft to give the pulses at just the right time. Or, an R-C sweep circuit can be built right in the wobulator and its output fed through the horizontal amplifier instead of using the c.r.o. built-in sweep. This R-C circuit can be connected to a shorting

switch on the condenser shaft, which allows the condenser voltage to build up and then discharges it every rotation.

ELECTRONIC WOBBULATION

The oscillator control circuit, which is the heart of the automatic frequency control system, provides a means of getting electronic wobulation. You will recall that by connecting a tube to

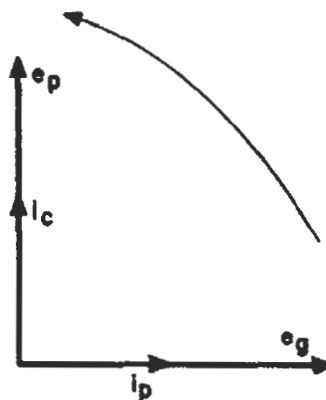

FIG. 28. The current and voltage relationships in the oscillator control circuit.

the oscillator circuit properly, we can make the tube act as an inductance coil. Then, by feeding a control signal to the tube, we can obtain an inductance which varies at a regular rate, thus varying the main oscillator frequency at the same rate.

The Oscillator Control. You will recall that one of the important characteristics of an inductance is the fact that the voltage leads the current by 90° . Therefore, any device which will exhibit this characteristic is acting just like a coil. As a review, refer to Fig. 27. Here we have a tuned-plate oscillator, connected so the plate current of the control tube must flow through tank coil L_1 . This plate current is made 90° out of phase with the plate voltage.

The phase shift in the plate current is obtained by using the network C_3 , R_3 and C_4 , which is connected across the tank circuit. As the resistance of R_3 is large compared to the reactances of C_3 and C_4 , the current i_c is in phase with e_p , as shown in Fig. 28.

As the current i_c flows through condenser C_4 , the voltage drop across this condenser

will be 90° behind the current i_p . This is the normal action of a condenser. Therefore, the voltage e_g lags current i_p by 90° .

The plate current flowing through tube VT_2 follows the grid voltage e_g . When e_g becomes positive, the plate current increases, and vice versa. Therefore, the plate current i_p is in phase with the grid voltage e_g . Since e_g is 90° out of phase with e_p , this means the plate current is likewise 90° out of phase with the plate voltage. Furthermore, it lags

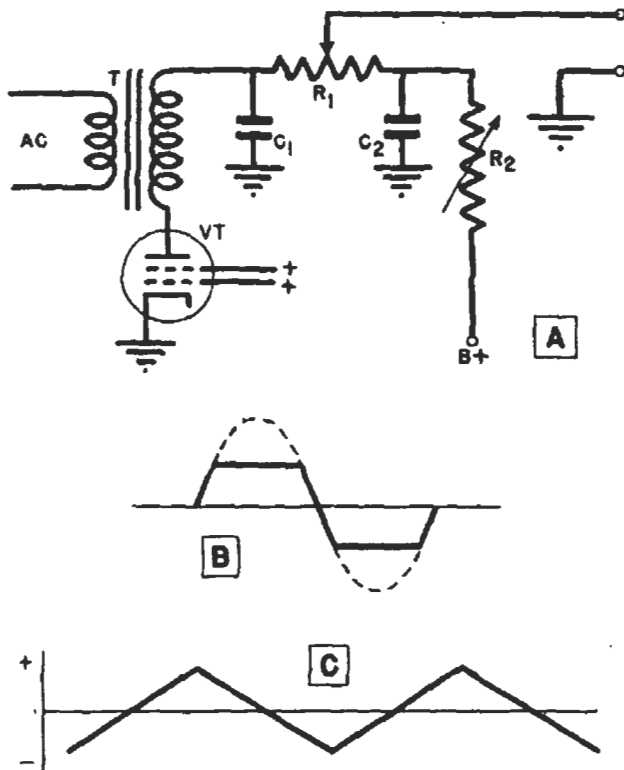

FIG. 29. A circuit for producing a triangular or pyramid wave shape.

behind the plate voltage, which is correct relationship for an inductance.

The value of resistor R_2 is chosen so that the tube draws some particular amount of current, so it acts as an inductance of a certain value. This inductance is in parallel with coil L_1 . This lowers the effective amount of inductance, but condenser C_1 is adjusted to where the proper frequency is obtained.

Control Pulses. Now, when we apply control pulses to the input of the oscillator control tube, the plate current drawn by the tube will vary according to these control pulses. When the grid becomes more positive, the tube draws more current, thus acting as a smaller inductance. This reduces the effective inductance of the tank

circuit so that the circuit is tuned to a higher frequency. On the other hand, when the control pulses add to the bias, this reduces the current, making tube VT_2 act as a larger inductance, and thus tunes the circuit to a lower frequency. By adjusting the value of the control pulse amplitude, we can get a fixed amount of swing about the normal or resting frequency.

For the purposes of drawing a characteristic curve, we want the frequency to be swept over this band of frequencies at an even and steady rate, first up, then back down over the same frequencies. This means the control pulse must swing gradually positive, then gradually negative. This form of change is produced by a voltage having a triangular or pyramid shape.

A circuit for producing this special wave is shown in Fig. 29A. Essentially, this is an amplifying tube, adjusted to operate on a characteristic having a short straight portion. Then a high value of a.c. is applied, so that the tops and bottoms of the swings are cut off by the characteristic curvature, pro-

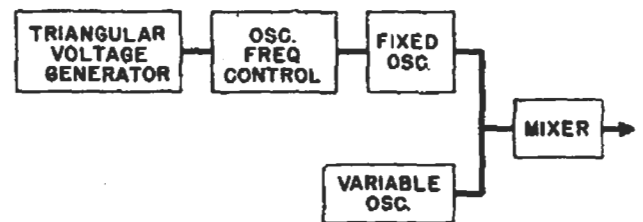

FIG. 30. This block diagram shows how the sections of an electronically wobulated oscillator are connected together.

ducing a square-wave shape as shown in Fig. 29B. These square-wave current pulses must pass through the filter $C_1-R_1-C_2$. As a result of the time constant of the filter, a wave shape which is like that shown in Fig. 29C will be obtained. This is the desired wave shape. The voltage can be varied by adjusting the slider on R_1 , which makes it possible to vary the range over which the oscillator frequency is

changed. Thus, the sweep can be adjusted to be any desired width from perhaps 5 kc. to 40 kc.; this is not possible with a mechanical system.

Complete Wobbulator. The triangular voltage generator is connected to the oscillator frequency control, which in turn varies the frequency of the fixed oscillator over the desired band. The output of the fixed oscillator is fed to a mixer-detector circuit, along with the output from a standard variable frequency oscillator, as shown in Fig. 30. The "mixing" action is exactly similar to that in the mechanical wobbulator already described, producing a signal that varies over the pass band at a regular rate.

This particular oscillator can be used for ordinary alignment, as well as high-fidelity alignment. However, most servicemen purchase a standard oscillator, then obtain a separate wobbulated oscillator when their high-fidelity business warrants. The reason for this is that the wobbulated oscillator, because of the mixing action, has in its output several frequencies, just as there are several frequencies in the plate circuit of a converter tube. The extra frequencies would prove very confusing if a receiver is far out of alignment. For such receivers, a standard signal generator should first be used to get the receiver approximately lined up, and the wobbulator can then

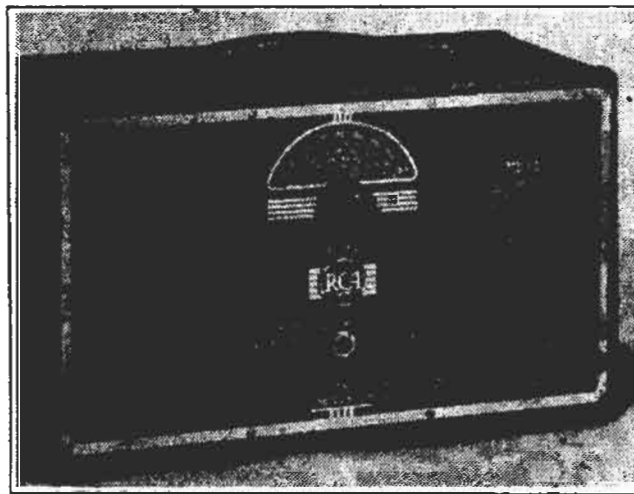

Courtesy RCA

FIG. 31. A typical electronic wobbulator. It looks like an ordinary signal generator except for having an adjustable sweep control and an extra position on the modulation switch.

► Fig. 31 shows the picture of an electronic wobbulator of this kind. The controls are not greatly different from those of a standard signal generator. However, in this particular case, there are two adjustments for attenuating the output, and the modulation switch has an extra position for frequency modulation or wobble. The control at the upper left varies the amount of the pyramid voltage fed to the oscillator control, and thus varies the width of the sweep.

be used for final alignment, in high-fidelity cases.

WOBBULATOR ALIGNMENT

Let's take a wobbulator and actually use it to line up a high-fidelity receiver. We would connect it to the first detector grid just as usual for i.f. alignment, through a blocking condenser. Then, assuming a diode second detector, the c.r.o. vertical input would be connected across the load resistor.

A connection must then be made from the wobulator to the sweep control circuit on the c.r.o. The receiver, oscillator and c.r.o. are turned on and allowed to warm up.

► Now, suppose the oscillator is set to the i.f., and the sweep frequency is ad-

460-kc. i.f. value (450 kc. to 470 kc.).

Each one of the humps on the screen will have a shape similar to the response characteristic of the amplifier. However, it is difficult to tell with this kind of curve just when the middle or resting frequency of the oscillator is at

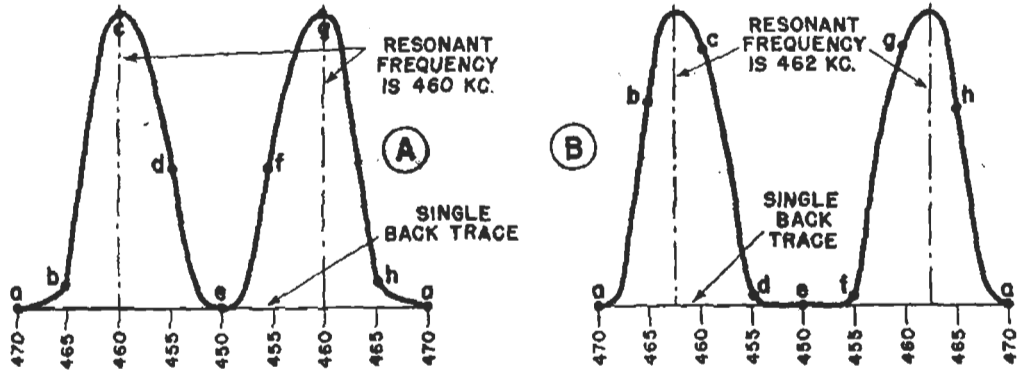

FIG. 32. The double hump resonance curve pattern is obtained when the c.r.o. sweep is set to the same rate as the wobulation. This pattern does not indicate clearly when the circuits are resonant to the resting frequency of the oscillator.

justed for a stationary pattern, at the same rate as the wobulation. The result will be a double-hump pattern as shown in Fig. 32A. You can see the reason for this if you will remember that the wobulator goes through the resting frequency twice for each cycle

the mid-frequency of the i.f. pass-band. For example, as shown in Fig. 32B, the oscillator has been moved to 462 kilocycles. Comparing A with B shows that there is very little difference in the appearance of these waves. ► The solution to our difficulty is to

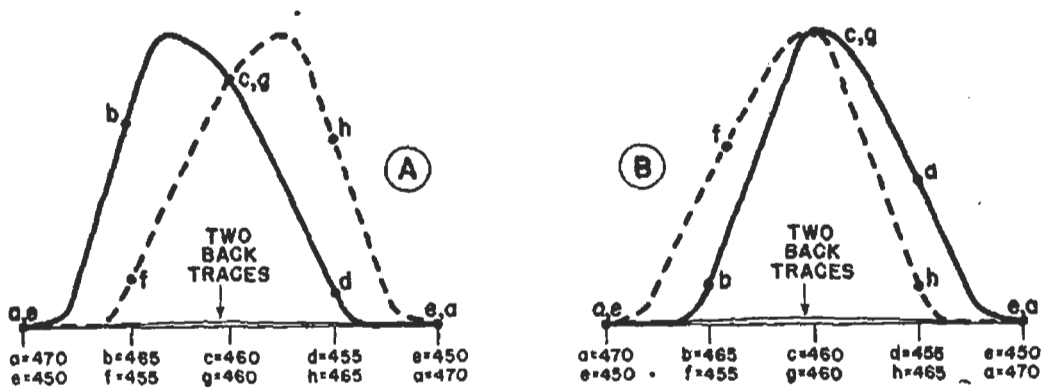

FIG. 33. This overlapped pattern is the one usually used for band-pass alignment. It is obtained by making the sweep frequency twice the wobulator rate.

of revolution of the revolving condenser, or twice for each cycle of the triangular sweep wave. In this particular instance, we have a wobulator sweeping over a band 20 kilocycles wide, 10 kilocycles on each side of the

adjust the sweep frequency of the c.r.o. to twice the wobulator rate. Then, we only have time for one of the variations for each cycle of the sweep, with the result that the two "humps" are placed one on top of the other, as

shown in Fig. 33. This overlapped pattern is the one normally used for high-fidelity alignment, so most mechanical and all electrical systems provide a controlling voltage twice the wobulator rate.

► Starting from point *a* and moving to point *b*, etc., you will find that the tracing is made through the resting frequency, then snapped back to the beginning and another trace is formed, apparently behind the first one. Notice the frequency goes up for one trace and down for the overlapped trace. This means the upper and lower halves of the band pass curve are overlapped, so we can see directly when both halves are alike.

► If we are not exactly in resonance, the tracings will separate to a position similar to that of Fig. 33A. As we tune to resonance, however, one tracing moves behind the other one. When we are exactly in resonance, the two peaks will exactly coincide, as shown in Fig. 33B.

Therefore, the receiver can be tuned to the proper resting frequency by making these peaks coincide. Now, the sides of the traces do not coincide until the proper alignment has been obtained. Therefore, the alignment of our band-pass, high-fidelity i.f. can now be made by causing the peaks to spread out to the proper flat-top shape, with the two humps exactly coinciding with each other. Therefore, we first must peak-align the i.f. amplifier, then must increase the capacity of one trimmer and decrease that of the other on each transformer, so the primaries and secondaries are tuned above and below the proper frequency, to get the band pass curve.

If you turn the adjustments too far, you will detune the circuit so the shape of the wave will change or the peaks may even separate. Typical distorted

waves are shown in Figs. 34A and 34B.

► When a band-pass circuit is perfectly adjusted, you will get a figure something like Fig. 34C. Incidentally, you can determine the amount of band-passing (an important adjustment), because the length of the back-trace line between points 1 and 3 of Fig. 34C corresponds to the sweep band width of the oscillator. The resting frequency is at point 2. If the sweep is adjusted for 30 kilocycles, the distance from point 1 to point 3 will be 30 kilocycles. Therefore, you will have to be sure that you have obtained the proper amount of band-passing by comparing the spacing of the sides of the image with the back-trace length. For ex-

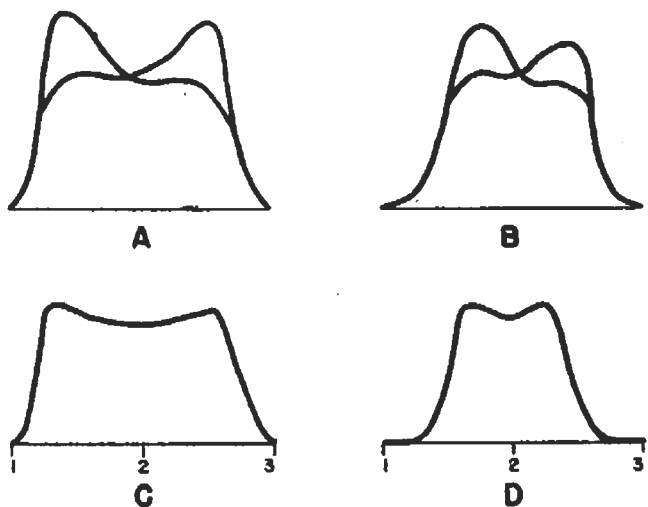

FIG. 34. Typical distorted patterns are shown in A and B. The band width of the pass-band can be determined by comparing the spacing of the sides of the pattern with the length of the back-trace line. Thus, C shows a circuit band-passed to the full limit of the wobulator range, while D shows a pass-band of about half as much.

ample, in 34D the circuit is band-passed, but only for a 10- or 15-kilocycle band width. This may be all the set is designed for. However, if the set should have a wider band width, the adjustments should be continued so the flat top is retained, but the sides are moved further apart.

Connecting the C.R.O. Practically all high-fidelity receivers will have a

diode second detector, using a resistive load, as in Fig. 35. The c.r.o. should be connected across resistor R_2 when band-passing the receiver. When the receiver uses A.F.C., the connection is made across the audio load. This is R_{24} in Fig. 36.

Should the receiver happen to use transformer coupling, or should the connection be made to an audio stage

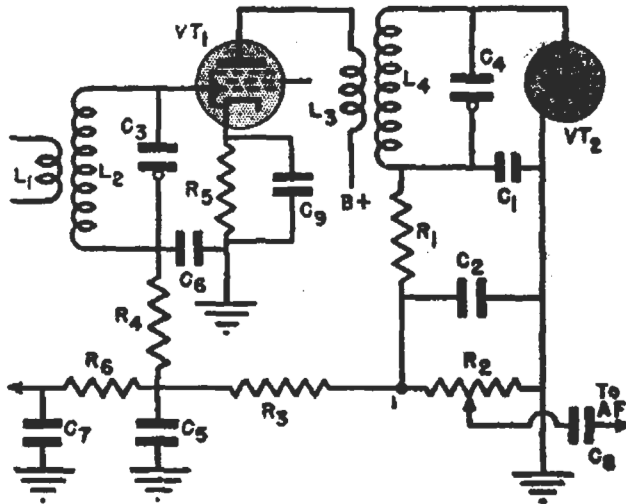

FIG. 35. Tube VT_2 is a typical diode detector of the type usually found in high-fidelity receivers. The c.r.o. should be connected across R_2 .

instead of the detector, phase distortion may occur. This causes part of the image to exist below the back-trace line as shown in Fig. 37. Phase shifts distort the wave to a useless form insofar as determining proper band-passing is concerned, so must be avoided. Where transformers are found, replace the primary temporarily with a 10,000- to 50,000-ohm resistor, or connect a 20,000- to 25,000-ohm resistor in parallel with the primary, with the c.r.o. connected across the resistor.

Interference Patterns. Several kinds of interference may develop, depending on set design and local conditions. Typical patterns are shown in Fig. 38. If an interfering signal comes in, patterns like *A* and *B* may be found. Tune the preselector to some frequency

causing no interference when this occurs.

Noise produces similar breaks and jagged patterns, but is usually more irregular than the patterns shown.

► Modulation of the wobulator with an audio tone, due either to a fault in the instrument such as hum modulation, or to having the amplitude modulation turned on, will produce patterns like *C*. Most wobulators now have a switching arrangement which makes this double modulation impossible except when defects occur.

► Ghost images as in *D* occur when harmonics of the wobulator get into the circuit. When aligning the i.f. amplifier, a harmonic may feed into the

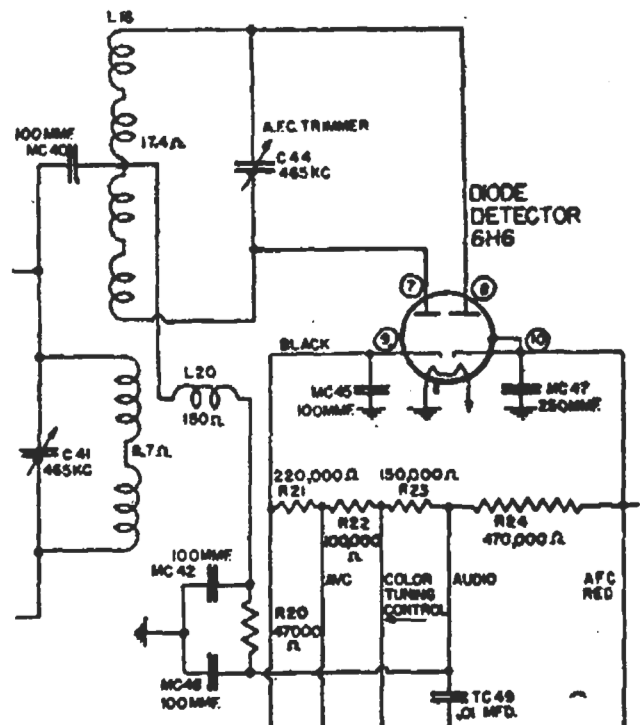

FIG. 36. The discriminator circuit of a General Electric receiver with a.f.c. The audio output is obtained across R_{24} , so the c.r.o. should also be connected across this resistor.

preselector and come through like an interfering signal. Tune to a different point on the dial or stop the receiver oscillator to clear this up.

► R.F. voltages in the detector load may produce a blurred image like *E*,

instead of the clear, sharp image shown at *F*. In a well-designed receiver, this occurs only when the detector r.f. filter is defective.

► Should regeneration occur in the i.f. amplifier, there may be a sharp peak at the resting frequency, with an unsymmetrical side condition. It may be impossible to get true band-passing until this trouble is cleared up, as the peak will remain sharp instead of broadening properly. This same pat-

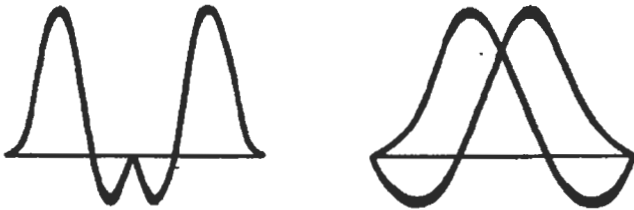

FIG. 37. Connecting the c.r.o. across a transformer or to an audio stage instead of the second detector produces a phase shift, pulling part of the pattern below the back-trace line and so distorting the pattern that it cannot be used.

tern would occur if the coupling between the i.f. transformers is changed in any way.

If oscillations develop, particularly at a frequency slightly different from the wobulator output, an interference pattern like that shown in Fig. 38C may be produced.

► From this section, you can see that the combination of wobulator and c.r.o. is necessary for the proper alignment of high-fidelity receivers, and will in addition indicate the presence and nature of a number of misadjustments and faults that could be difficult to find by other means.

PRACTICAL HINTS

Let us now review the basic procedure for high fidelity alignment, to be sure the proper procedure is followed.

► First, the receiver must be peak-aligned by following the standard pro-

cedure, particularly if any tampering has occurred. Then, the wobulator is connected to the grid of the first detector and the c.r.o. is connected across the second detector load. The preselector is tuned away from any interfering station frequency—usually to the low frequency end of the band.

The wobulator is tuned to the i.f. frequency, then the c.r.o. sweep is adjusted to give the double or overlapped trace, with a fixed image. Assuming the wobulator to be producing the correct i.f., the adjusters are varied to get coinciding peaks, then adjusted for a flat-topped, square-shaped band-pass characteristic, with the sides of both traces coinciding. The width of the pass band should be adjusted as is proper for the set, comparing with the length of the back-trace line, which corresponds to the band width for which the wobulator is set.

► To complete the high fidelity alignment procedure, the wobulator should be moved to the input of the receiver and a check of the overall response made. The c.r.o. remains connected to the diode load of the second detector.

The wobulator is now of course

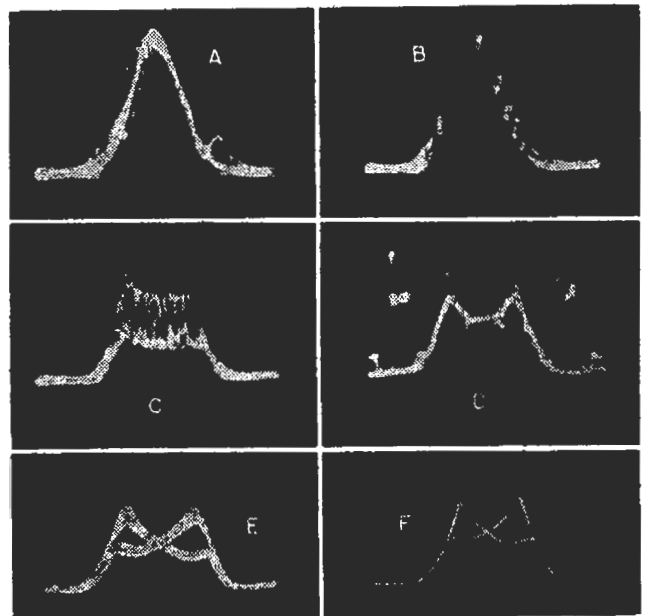

FIG. 38. Typical interference patterns.

tuned to some frequency within the broadcast band and the receiver is tuned to the same frequency. The output wave shape should be very similar to that attained through the i.f. amplifier alone. Normally, the preselector is not band passed, but is so broadly tuned that it does not appreciably affect the shape of the output wave. If any alignment adjustments are made on the preselector, it is important to see that the wave shape is not greatly changed.

► In some cases you may find that the band pass adjustments of the i.f. amplifier produce a wave having two rather pronounced peaks with a valley between. Check to be sure you are not trying to adjust for too wide a pass-band, as the receiver may be of limited fidelity. If the peaks are separated the proper distance for normal band passing, and the i.f. adjustments do not seem to make the top of the band pass wave more flat, then wait until the overall check has been made. You will usually find in such cases that the preselector selectivity is somewhat more sharp with the result that, when tuned exactly to resonance, it introduces a third peak between the two i.f. peaks. This peak "lifts" the valley, producing a more flat characteristic.

► Band pass adjustments normally will be made only on high fidelity receivers which are particularly designed for this purpose. However, you may get a request for improving the response characteristic of a receiver with variable selectivity, or some standard receiver. Let's see just what can be done in either case.

Variable Selectivity Receivers. These receivers have been covered elsewhere in the course. However, they are receivers where the selectivity and fidelity can be changed by introducing a variation of the i.f. amplifier band

width. The coupling between the transformers may be changed, loading may be introduced, or the primary and secondary may be detuned from the normal response frequency to give a flatter overall response. Two types of controls may be available, a switch type having two positions, or a continuously variable control.

► In any case, the normal adjustment is one of peaking the receiver with the control set in the maximum selectivity position. Ordinarily, the standard alignment procedure would be followed assuming the receiver is designed to



The wobblator at the left is connected to the receiver and a synchronizing connection is made to the horizontal input of the c.r.o. The vertical input is connected to the diode load of the second detector. As adjustments may be above the chassis, the connections to the set must be firmly made and of sufficient length to permit moving the set about. Hook-up wire is frequently more useful than test leads, as you can solder the wires to the desired points in the radio, thus being assured the connections won't jump off during alignment.

give reasonable fidelity in the broad selectivity-high fidelity position.

► Where there is any question about this, you can proceed with the use of a wobulator in the manner described in this lesson, with the control set in the high-fidelity position. In other words, first make the peak alignment, then move the control to its maximum fidelity position and proceed to band pass the amplifier.

Always remember that these two adjustments interlock. If you adjust to where you have the maximum in fidelity, you will probably find that when you return to the sharp tuning position you no longer have quite as much selectivity. It probably will be necessary to reach some compromise between selectivity and reasonable fidelity in these cases. Be sure the receiver owner understands this before you start this alignment procedure.

Standard Receivers. The ordinary receiver is usually designed to have high selectivity, so peak alignment is the only alignment which is practical in most instances. True band passing cannot be obtained unless the i.f. transformer windings are critically coupled. However, in some instances, the transformers have sufficient coupling to give somewhat broader response if the band pass alignment procedure is followed.

Obviously, it is a waste of time to band pass a receiver where the audio amplifier is incapable of better response. However, if the owner does desire better response, you can try band-passing.

In such cases, peak align the receiver as in the normal procedure. Then proceed to try to make a band pass adjustment (that is, decrease the capacity of one trimmer and increase the capacity of the other on the same i.f. transformer). In this case you are ac-

tually tuning one winding of each transformer above the proper frequency and the other winding of the same transformer below the proper frequency, so as to get a broader response. If the transformers are under-coupled, the sharp peak will drop, forming a broader, more rounded peak. Of course, this adjustment cannot be carried too far, for the loss in sensitivity and selectivity will be too great to permit anywhere near normal distant station response.

► Where the coupling is close to the critical value, more of a flat-topped, band-pass characteristic is obtained. Even so, it is rarely advisable to try to band pass such an ordinary receiver beyond the point where a pronounced valley begins to appear between the peaks. However, it is sometimes possible to load the i.f. transformer windings by placing resistors between 10,000 and 100,000 ohms across the secondary of each of the i.f. transformers. Use the *largest* resistor value which will give you the response you are trying to obtain. Smaller resistor values improve the response further, but at too great a sacrifice of selectivity and gain.

► Again, it is necessary to explain to the receiver owner the fact that more interference may exist, and fewer distant stations will be picked up when any kind of band pass adjustments are made on these sets.

F. M. ALIGNMENT

Although a high sensitivity meter is usually used as an indicator for F.M. alignment, it is possible to make use of the c.r.o. and a wobulator, giving a visual alignment method which will show the exact i.f. and discriminator response characteristics.

Suppose we have to align an F.M.

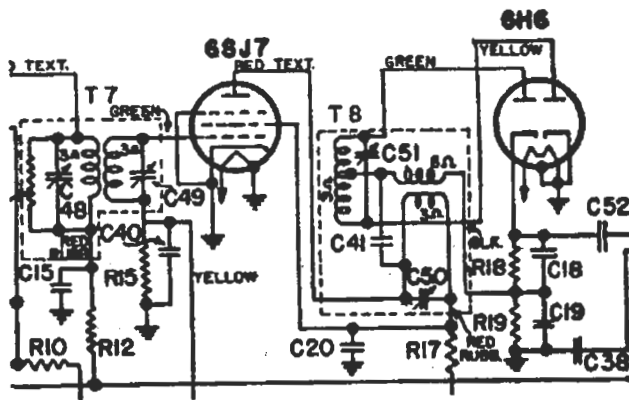

FIG. 39. The limiter-discriminator section of the General Electric Model GM-125 frequency modulation receiver.

receiver having a discriminator and limiter as shown in Fig. 39. Normally, the indicator is connected across the grid resistor of the limiter first. This is resistor R_{15} in the diagram. Then, after having aligned for a maximum indication here, the output indicator is moved to the output of the discriminator and the discriminator transformer adjusted. As you will recall from your study of frequency modulation, the

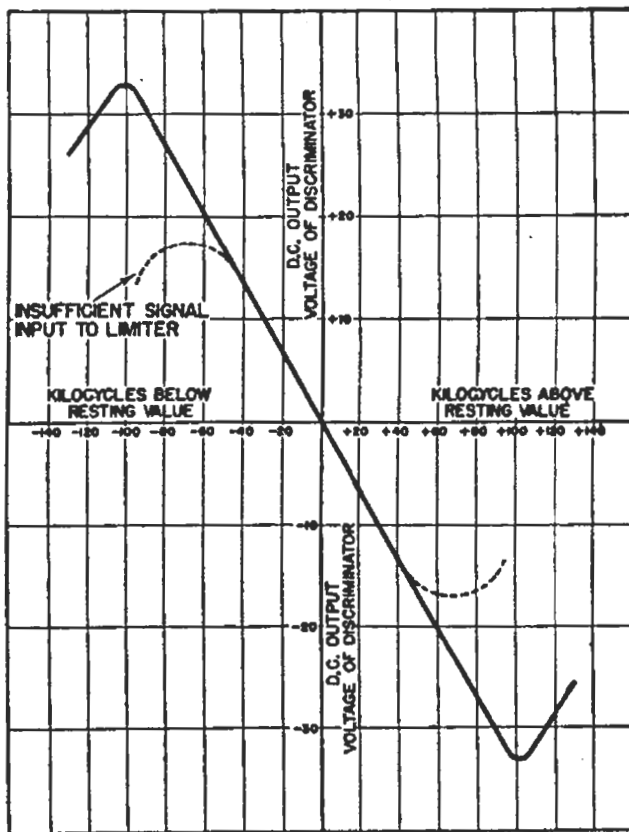

FIG. 40. The S curve shows how the output voltage of the f.m. discriminator varies with frequency deviation.

operating curve of this discriminator forms an S curve, when comparing frequency shift with the discriminator output. A typical S curve is shown in Fig. 40.

In order to use the c.r.o., the frequency modulated signal generator must be capable of covering the i.f. band width of 200 to 300 kc., which means that the sweep must be from 300 to 400 kilocycles wide. This requires a special frequency modulated oscillator, as the ordinary types previously discussed for A.M. radio receivers are incapable of going much beyond 40 kilocycles.

With this wobblator connected to the input of the first detector in the F.M. receiver, and set to the i.f. frequency of the receiver, the c.r.o. is then connected across resistor R_{15} . Usually a resistor of about 500,000 ohms is used in series with the c.r.o. lead to

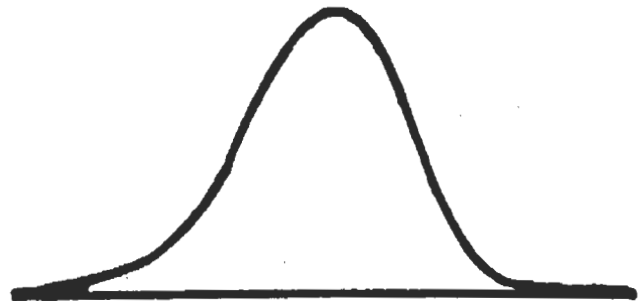

FIG. 41. The response curve of a typical f.m. receiver i.f. section. It does not look broad, but actually is, as the wobblator sweep is plus or minus 100 to 150 kc., so the back-trace line represents 300 to 400 kc. and the pattern is then 200 kc. or more wide. (Plus or minus 100 kc. gives a band width of 200 kc.)

keep the c.r.o. from affecting the circuit action.

With the c.r.o. connected to the grid circuit of the limiter, the i.f. adjustments are made for a maximum peak response as shown in Fig. 41. This may seem surprising until you consider the fact that the back trace now represents perhaps 400 kilocycles, so the sides of the image in Fig. 41 are from 150 to 200 kilocycles apart. This definitely is

a very broad pass band even though the overall shape of the curve does not appear to be as flat-topped as one might expect. However, remember the band-pass is obtained by connecting resistor loads across the transformers and this does not give a flat-top band-pass characteristic.

After this adjustment has been made satisfactorily, the c.r.o. connections are then moved to the output of the discriminator. Connect across both resistors R_{18} and R_{19} of Fig. 39. One lead goes to the C_{52} - R_{18} junction and the other to the chassis.

With the frequency modulated oscillator still connected to the first detector and tuned to the same frequency, you will now get a representation of the S curve. The c.r.o. sweep should be adjusted to where you get two of these curves, as shown in Fig. 42. Now, ad-

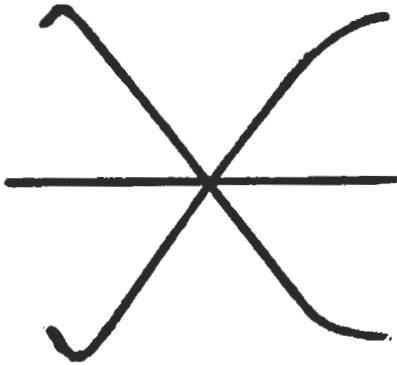

FIG. 42. This double S curve obtained at the output of the discriminator tells when the discriminator transformer is correctly adjusted.

just the trimmers on transformer T_8 . As you adjust trimmer C_{51} , the curves will cross each other at different points. The correct adjustment of this trimmer is indicated when the curves cross about midway in a vertical plane. (This position is indicated by the horizontal line in Fig. 42.) Proper alignment of condenser C_{50} is indicated when the sides of the curves near the cross-over point are nearest to a straight line.

It is important that sufficient signal

be fed in to saturate the limiter. This level can be determined by increasing the output from the signal generator to the point where the amplitude of the cross-over curves no longer increase in height.

► Should the receiver be a combination F.M.-A.M. receiver, each section would be aligned separately in the standard manner. A typical output for such a receiver is shown in Fig. 43. Connect across R_4 for aligning the amplitude modulation section and across the R_1 - R_2 combination for the F.M. discriminator alignment.

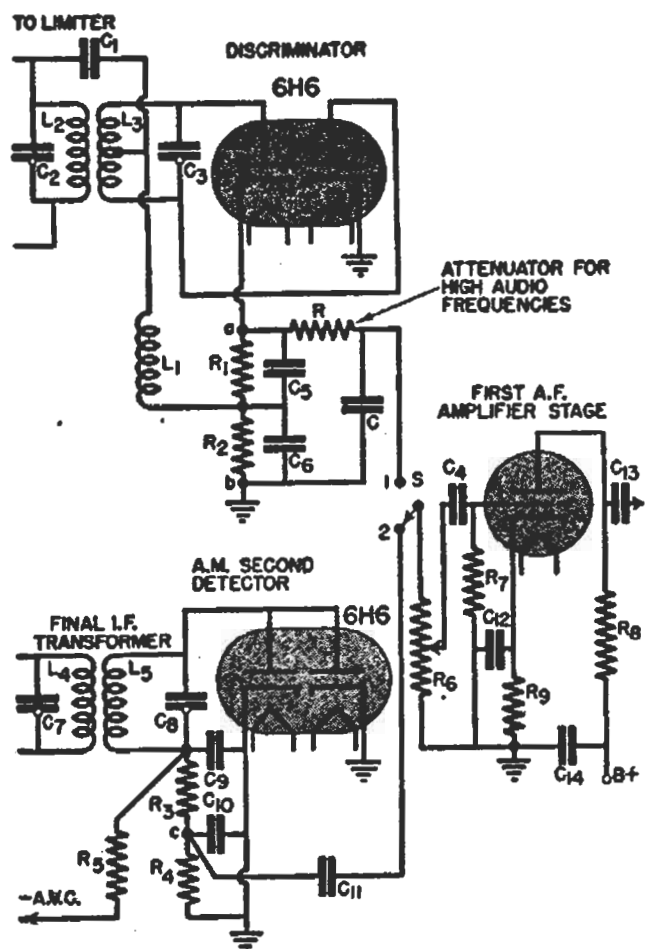

FIG. 43. The discriminator and second detector of a combination a.m.-f.m. receiver.

AUDIO RESPONSE CURVES

You will recall that an audio response curve like Fig. 19 requires a number of measurements over the frequency band. This tedious procedure can be avoided by using an f.m. oscil-



FIG. 44. How to connect a wobulated signal generator and a standard signal generator to a detector so as to obtain an audio sweep.

lator or wobulator to get an approximate curve.

The wobulator output is fed to the second detector, along with the output of another signal generator, as shown in Fig. 44. The two generators are adjusted for exactly the same frequency, so as to get a zero beat between them.

Now, as the wobulator output is varied over the sweep band, beat frequencies are produced by the detector between zero and half the sweep band width. If the sweep band is 20 kc., we will get audio frequencies from zero to 10,000 cycles.

As these frequencies are being swept over the audio band, synchronizing the c.r.o. will produce a tracing like Fig. 45. The wave runs from zero to 10,000 cycles, then repeats itself in reverse, so only half of the pattern is used. Also, the lower half (below line A-B) is ignored. The outline represents the audio response to a fair degree, provided the output of the wob-

ulator is reasonably flat and provided the detector does not introduce frequency distortion.

The response curve for low frequencies below about 10 times the sweep rate is not accurate. Thus, for a sweep rate of 60 times per second, frequencies between zero and 600 cycles are attenuated, because the amplitude does not have time to build up before the beat frequency has moved on to the higher frequencies. However, over the rest of the band, the response curve is fairly accurate.

► You, as a serviceman, should now realize that the c.r.o. is an instrument that can help you in many ways. The thorough knowledge of the c.r.o. which you have gained from this lesson will not only enable you to make the specific service applications described, but will give you a valuable basic understanding of the many, many uses of this wonderful instrument throughout science.

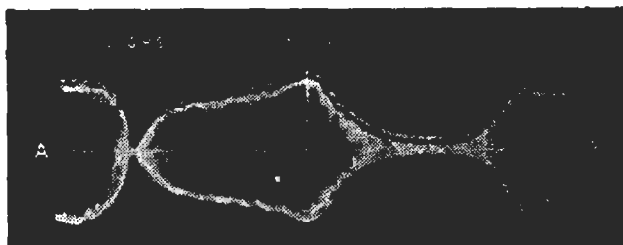

FIG. 45. By using the portion between zero and 10,000 cycles and ignoring the tracings below the A-B line, we have a pattern showing the frequency response of an audio amplifier. The pattern is not reliable below 600 cycles, but above this point is reasonably accurate.

THE N. R. I. COURSE PREPARES YOU TO BECOME A
RADIOTRICIAN & TELETRICIAN
(REGISTERED U.S. PATENT OFFICE) (REGISTERED U.S. PATENT OFFICE)

Lesson Questions

Be sure to number your Answer Sheet 40RH-2.

Place your Student Number on every Answer Sheet.

Send in your set of answers for this lesson immediately after you finish them, as instructed in the Study Schedule. This will give you the greatest possible benefit from our speedy personal grading service.

1. What is the purpose of varying the voltage on anode P_1 in Fig. 2?
So that the beam of electrons can be focused.
2. Is the voltage to be analyzed normally connected to the vertical deflecting plates, or to the horizontal deflecting plates?
3. Why should the synchronizing voltage (SYNC control) be adjusted so the least amount giving a stationary image is used? *To high a setting can cause distortion because of a non-linear sweep*
4. Suppose the sweep is set for 60 cycles, and as you trace for hum, you get a two-cycle pattern. Is the hum due to: a, cathode-to-heater leakage; b, pick-up from the filament wiring; or c, defective filter condensers?
5. Suppose only one-half a wave image is distorted. Does this show: a, even harmonic distortion; or b, odd harmonic distortion?
6. Which two of the following phase shifts will produce a perfectly circular pattern. (assuming equal amplitudes): 45° ; 180° ; 90° ; 0° ; or 270° ?
7. Is the c.r.o. sweep set to the same frequency as the wobulator rate, or is it set to twice this rate, to get an overlapped band-pass pattern?
8. If the peaks of the overlapped alignment pattern do not coincide, what condition is indicated? *The c.r.o. and the I.F. transformers are not in resonance.*
9. When the beam is not being swept, it is necessary to prevent the spot from burning the screen of the c.r.o. tube. Name the control used to do this, and tell how it is adjusted. *The intensity control. The c.r.o. is turned on and after warm up, the intensity control is advanced just enough.*
10. In what directions are the i.f. trimmers varied to get band pass response, after the initial peak adjustment has been made? *One trimmer must be increased and the other decreased on each I.F. transformer.*