

EX LIBRIS





THE THERMIONIC VALVE AND
ITS DEVELOPMENTS IN
RADIOTELEGRAPHY
AND TELEPHONY

Unit of
Columbus

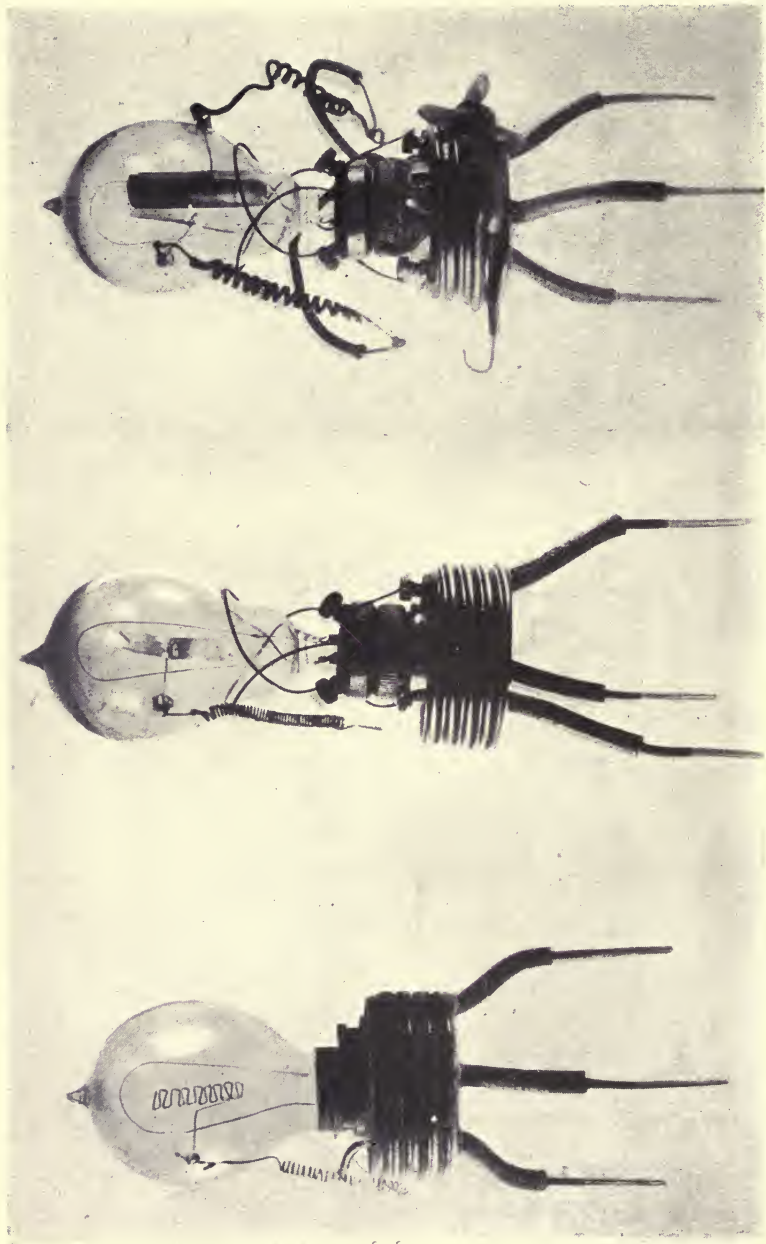

PHOTOGRAPHS OF THE OSCILLATION VALVES FIRST EMPLOYED BY DR. J. A. FLEMING, F.R.S., IN OCTOBER, 1904, FOR THE RECEPTION OF HIGH-FREQUENCY ELECTRIC WAVES AS USED IN WIRELESS TELEGRAPHY.

THE
THERMIONIC VALVE
AND ITS DEVELOPMENTS IN
RADIOTELEGRAPHY AND TELEPHONY

BY

J. A. FLEMING, M.A., D.Sc., F.R.S.,

*University Professor of Electrical Engineering in the University of London, Member of the
Institution of Electrical Engineers, Member of the Royal Institution
of Great Britain, etc., etc.*

AUTHOR OF

"THE PRINCIPLES OF ELECTRIC WAVE TELEGRAPHY AND TELEPHONY," "AN ELEMENTARY
MANUAL OF RADIOTELEGRAPHY AND RADIOTELEPHONY," "THE WIRELESS
TELEGRAPHIST'S POCKET BOOK OF NOTES, FORMULÆ AND
CALCULATIONS," "THE WONDERS OF WIRELESS
TELEGRAPHY," ETC., ETC.

LONDON

THE WIRELESS PRESS, LTD.

12 & 13 HENRIETTA STREET, STRAND, W.C.2

SYDNEY, N.S.W.: 97 CLARENCE STREET

MELBOURNE: 422/4 LITTLE COLLINS STREET

NEW YORK

WIRELESS PRESS INC.

25 ELM STREET

MADRID

LA PRENSA RADIOTELEGRAFICA

43 CALLE DE ALCALA

ROME

AGENZIA RADIOTELEGRAFICA ITALIANA

VIA GREGORIANA, 36

ROTTERDAM

NEDERLANDSCH PERSBUREAU RADIO

BOOMPJES 23A

1919

ERRATUM.

Footnote on p. 139 *should read,*
Figs. 75, 76, 77.

ALL RIGHTS RESERVED.

70 100 150
100 150 200

PREFACE

THE present extensive use of appliances in modern radiotelegraphy and radiotelephony based on the thermionic emission from an incandescent cathode in a vacuous bulb, of which the Fleming oscillation valve was the first representative, has given rise to much published information on the subject in technical journals as well as to numerous patent specifications. Since most of the recent great advances in wireless telegraphy and telephony are dependent on the employment of these inventions it seemed desirable to collect together in a single volume some of this literature for the assistance of radio-engineers. The author, therefore, accepted the invitation of *The Wireless Press, Limited*, to write a small book on the practical side of the subject.

It has not been deemed necessary to enter very fully into the purely scientific researches on thermionic emission from incandescent substances, because it has already been treated very fully by Prof. O. W. Richardson in his excellent monograph, *The Emission of Electricity from Hot Bodies* (Longmans, Green & Co., London).

The introductory chapter of the present volume, nevertheless, provides a brief sketch of the researches which led up to the practical applications described in subsequent chapters. The author has, however, felt it necessary to explain in rather full detail the history of this practical application by himself and others, and of the patent litigation which has taken place in the United States and in Great Britain in connection with it, on account of the efforts which have been made to depreciate the Author's work on this subject. The legal judgments in these actions are printed as an appendix, and will enable the reader to view the questions of priority of invention from the standpoint of unbiassed and competent judges.

One other matter calls for remark, and that is the question of nomenclature. The essential structure of all the devices described in the following pages is a bulb of glass or other

material more or less perfectly evacuated, and containing a filament of carbon or metal which can be rendered incandescent, and also used as a cathode for an electric discharge, the bulb also containing one or more cold metal anode plates or grids. To various forms of this instrument a very large number of names have been applied. The single anode bulb was originally named by the author an *oscillation valve*, and it has generally in Great Britain been since called a *valve detector*, *Fleming valve*, or *Thermionic valve*, but in the United States varieties of the two anode form of it have been christened *Audion*, *Oscillion*, *Kenotron*, *Pliotron*, *Dynatron*, *Pliodynatron*, *Ultraaudion*, *Tungar*, and by other trade names. Such plenitude of appellation is puzzling to the uninitiated, and the names are not very self-explanatory. All the instruments depend entirely for their radio use on the same physical fact—viz., the emission from an incandescent cathode of *ions* of some kind. Prof. O. W. Richardson has called these bodies *thermions*. For the most part, and at high temperatures, the thermions are the so-called electrons or ultimate negative corpuscles or atoms of negative electricity.

Since these thermions are not different in nature from the ions liberated by other agencies, such as ultra-violet light, radio-active substances or X-rays, it is permissible to raise the question whether a special name is really required for the ions liberated from incandescent bodies. Appliances depending upon this emission have, however, been rightly named thermionic appliances. The author has accordingly ventured to borrow Prof. Richardson's term and to use the word *thermion* occasionally as an abbreviated name for any radiotelegraphic instrument depending upon this thermionic emission, in place of the longer words thermionic valve, amplifier or oscillator. It is easy and self-explanatory then to speak of a high vacuum or low vacuum thermion, or of a two-electrode or three-electrode thermion, and such phrases are, perhaps, more descriptive than artificial words like Kenotron, Pliotron, Dynatron, etc.

Some agreement on this question of nomenclature seems desirable if only to prevent the too exuberant growth of strange words which are merely trade names for modifications of generically similar devices. The author submits, therefore, this suggestion tentatively to the radio-engineering fraternity.

RADIOTELEGRAPHY AND TELEPHONY

As considerations of the present cost of paper and printing in time of war have imposed severe limitations upon the size of the present book, it has not been found necessary to include detailed descriptions of every so-far devised circuit or scheme for using thermionic instruments as detectors or generators in radio work, nor mention of every patent specification taken out in connection therewith. Sufficient information has, perhaps, been given to enable the practical or incipient radiotelegraphist to understand the principles involved in the various stages of invention. The recent advances in radiotelephony are entirely based on the utility of the thermion as detector, amplifier, and generator of electric oscillations, and are due to the large number of inventive and scientific minds which have been brought to bear on the subject since the author made the pioneer invention (*see Appendix*). It is hoped that justice has been done to all contributors as well as to those authors on the subject from whom the present writer has drawn information.

The author is indebted for the use of diagrams and blocks to *The Wireless Press, Limited*, for illustrations taken from articles in *The Wireless World* and in *The Year Book of Wireless Telegraphy and Telephony*, many of them being from an article by Dr. W. H. Eccles on "Ionic Valves," and many others from excellent articles by Mr. J. Scott-Taggart which have appeared in *The Wireless World* recently. Also to the Editor and Proprietors of the *Proceedings of the Institute of Radio Engineers* of New York for many diagrams taken from papers in this journal, and to the Council of *The Institution of Electrical Engineers*, London. The author desires to record his obligations to the editorial staff of *The Wireless Press, Ltd.*, and especially to Lieut. G. M. Wright, of the Marconi Company's engineering staff for assistance in collecting information, particularly that on the thermionic apparatus made by Marconi's Wireless Telegraph Company, Ltd.

London, June, 1919.

J. A. F.

CONTENTS

CHAPTER I.

| | PAGE |
|--------------------------------|------|
| HISTORICAL INTRODUCTION | 1 |

1. The Development of Radiotelegraphic Detectors.—
2. Various Types of Detector. Coherers, Magnetic, Electrolytic, Crystal and Thermionic.—3. The Evolution of the Electric Glow Lamp, by Edison, Swan and Stearn. "Molecular Shadows" in Glow Lamps. The "Edison Effect." Investigations of it by Preece and the Author. Scattering of Carbon Molecules and Emission of Negative Electricity from the Glow Lamp Filament. The Author's Discovery of a Similar Effect in the Arc Lamp and in Air at Ordinary Pressure.—4. Relations of Heat and Electricity. Guthrie's Discovery. Work of Elster and Geitel.—5. Investigations of J. J. Thomson on Electric Discharge in Vacuum Tubes. Conveyance of Electricity by Ions. Laws of Electrolysis. The Electron.—6. J. J. Thomson's Work on the Conduction of Electricity Through Gases. Measurement of Ratio e/m . C. T. R. Wilson's Discovery of Condensing Power of Ions on Water Vapour.—7. Use of this Fact by J. J. Thomson to Determine the Value of the Electron Charge e . Ions Emitted by Incandescent Bodies. Thomson's Measurement of e/m for Thermionic Emission. Mass and Size of the Electron.—8. The Unit of Positive Electricity. Structure of the Atom. Electric Conduction. Electronic Theory of Electricity.—9. Experimental Study of Thermionic Emission by Richardson and others. Nature of the Ions Emitted. Thermionic Emission from Incandescent Tungsten. Richardson's Law Connecting Absolute Temperature and Thermionic Saturation Current.—10. Origin of the Ions Emitted from an Incandescent Wire. Wehnelt's Cathode. Emission of Negative Ions from a Nernst Glower. Emission of Positive Ions from Incandescent Wires.

CHAPTER II.

| | |
|--------------------------------------|----|
| THE FLEMING OSCILLATION VALVE | 46 |
|--------------------------------------|----|

1. Edison's Discovery of the "Edison Effect." Application of the "Edison Effect" by the Author to the Construction of an Oscillation Valve or Rectifier of High Frequency Currents. The U.S. Court of Appeals Judgment that this was not an Obvious Application. The Fleming Valve. Mode of Using it to Rectify Electric Oscillations. Measurement of the Rectifying Power or Efficiency.—2. Use of the Fleming Valve in Radiotelegraphy in 1905 as a Detector. Senatore Marconi's Mode of Use with a Telephone and Oscillation Transformer. Marconi-Fleming Valve Receiver Sets. Valves with Oxide-coated Cathodes. Experiments of Willows and Hill.—3. Study of the Characteristic Curves of Oscillation Valves. Differences

in the Behaviour of High and Low Vacuum Valves. The Author's Second Mode of Using the Oscillation Valve as a Detector Depending upon Change in Slope of the Characteristic Curve at Certain Points.—4. High Vacuum or "Hard" Valves and Low or "Soft," Valves.—5. The Work of Irving Langmuir on Production of High Vacuum Valves. Langmuir's Temperature and Thermionic Current Characteristic Curves for Tungsten Valves. Relation of P.D. of the Electrodes and the Thermionic Current. Effect of Minute Traces of Gas on the Characteristic Curves of High Vacuum Valves. Tests for High Vacuum in Valves.—6. General Electric Company's High Vacuum Valve or so-called Kenotron.—7. Other Forms of Rectifying Valve. Wehnelt Oxide-Coated Cathode Valve. Low Vacuum Valves. The Tungar Rectifier.—8. Testing Oscillation Valves. The Author's Method with Electromagnetic Induction Circuits and Tilting Secondary Coil.—9. Processes for Making High Vacua. Electric Vacuum Furnaces. High Vacuum Pumps. The Gaede Molecular Pump. The McLeod Vacuum Gauge. Langmuir's Vacuum Gauge. Sir James Dewar's Method of Making High Vacua by Charcoal Cooled with Liquid Air. The Boiling Mercury Pump. Irving Langmuir's High-Speed High Vacuum Mercury Pump. The Cosmos Mercury Pump.

CHAPTER III.

THE THREE-ELECTRODE VALVE 102

1. The Three-Electrode Valve. Structural Improvement Due to Lee de Forest. Controversy with the Author. The Development of the Three-Electrode Valve. Litigation in the United States on the Valve Patents.—2. Analysis of Lee de Forest's Valve Patents.—3. The Judgment of His Honour Judge Mayer on the Valve Patents. The Fleming Valve Patent Upheld as Fundamental and not Anticipated by any Prior Publication. Court of Appeals' Judgment.—4. Physical Operation of the Three-Electrode Valve. Its Characteristic Curve. The Work of E. H. Armstrong in Analysing the Valve Operation. Modes of Using the Three-Electrode Valve as a Radiotelegraphic Detector.—5. Difficulties of Manufacture of Three-Electrode Valves. Different Forms of Construction. Lee de Forest's *Audion*. Spiral and Cylinder Three-Electrode Valve. The General Electric Company's *Pliotron*. Langmuir's Investigations on High Vacuum Three-Electrode Valves. Three-Electrode Gas Relay of Lieben, Reisz and Strauss. Type of Valve Most Useful in Radiotelegraphic Work.—6. Regenerative or Amplifying Methods of Using Three-Electrode Valves. Armstrong's Mode of Coupling.—7. Audio- and Radio-Amplification. Mode of Connecting up Three-Electrode Valves for Various Purposes in Audio- and Radio- Amplification.—8. Use of Three-Electrode Valves in Cascade for Multiple Amplification.—9. Measurement of Characteristic Slope of Three-Electrode Valves. A Method of Measuring the Slope at Any One Point by a Single Observation, due to E. V. Appleton.

RADIOTELEGRAPHY AND TELEPHONY

CHAPTER IV.

| | PAGE |
|---|------|
| THE THERMIONIC VALVE AS A GENERATOR OF ELECTRIC OSCILLATIONS | 148 |

1. First Recognition of the Oscillation Producing Power of the Thermionic Valve. Arrangement of Circuits employed by Meissner for Oscillation Production. Use of Lieben Relay for this Purpose. Circuits of E. H. Armstrong, H. J. Round and C. S. Franklin for the Auto-Production of Oscillations by the Three-Electrode Valve. Analogy with the Singing Telephone and the Duddell Arc Generator of Oscillations.—2. Mode in which the Grid and Plate Circuits React on Each Other when Coupled. Relative Advantages of Low and High Vacuum Valves for this Purpose. Analogy Between the Action of a Steam Engine and that of the Oscillation-Producing Thermion. The Proper Phase Relations of Grid Potential and Plate Current.—3. Inductive Coupling of Grid and Plate Circuits by Armstrong for Amplifying Oscillations. Arrangements Devised by C. S. Franklin for Magnifying Received Oscillations by a Grid and Plate-Coupled Thermion. British Patent Specification of H. J. Round for Thermionic Oscillator.—4. Methods of W. C. White for the Generation of Oscillations of Low or High Frequency by the Thermion. Utilising the Reaction Principle. Conditions for Prolonged Successful Operation of the Thermionic Oscillator.—5. The Dynatron Oscillator. Work of A. W. Hull thereon. Construction of the Dynatron Compared with that of the Ordinary Three-Electrode Valve. Utilisation of the Secondary Emission of Electrons from a Bombarded Anti-Cathode. Theory of the Dynatron. Form of its Characteristic Curve. The Negative Resistance of the Vacuous Space Rendering Possible the Auto-Production of Oscillations.—6. Properties of the Dynatron when in Connection with Circuits Having Resistance and Inductance.—7. Conditions for the Production of Oscillations by the Dynatron.—8. The Plio-Dynatron as a Generator of Controlled Oscillations for Radiotelephony. 9. Theoretical Study by L. A. Hazeltine of the Criteria for the Production of Oscillations by Three-Electrode Valves or Thermions in Connection with Various Types of Circuits. Conditions under which Direct Current Power is Transformed into Alternating Current Power by the Thermion Oscillator. Study of Various Cases and Types of Circuit. Mathematical Expressions for the Conditions of Oscillation Production Thereby.

CHAPTER V.

| | |
|---|-----|
| THE THERMIONIC DETECTOR IN RADIOTELEGRAPHY | 176 |
|---|-----|

1. Advantages of the Thermionic Detector in Respect of Non-Injury by Atmospheric Discharges. Qualities of it which Enable it to be Used for Elimination of Atmospheric as a Current-Limiting Device.—2. Two-Electrode Form as a Simple Rectifier of Oscillations and, in Conjunction with Telephone Receiver, as a Detector in Spark Radiotelegraphy. Two Modes of Use of Two-Electrode Valve as Detector.—3. Use of Three-Electrode Valve as Rectifier and Simple Detector. Dependence of Sensibility on the Point of

Working on the Characteristic Curve. Differences of High and Low Vacuum Valves. Method of Use Depending upon Change of Curvature at Points on Characteristic Curve.—4. Three-Electrode Thermion as Magnifier of Oscillations. Use as Amplifier with Crystal or Other Rectifier. Examples of Arrangement of Circuit for this Method of Detection in Radiotelegraphy.—5. Franklin's Method of Incrementing Received Oscillation Energy by Use of Three-Electrode Valve and Grid and Plate Coupling. Arco and Meissner's Arrangements for Amplifying Reception. Scheme of Connection of Circuits for Amplifying Reception by Three-Electrode Valve. Practical Details and Precautions. Adjustments with Soft and Hard Valves.—6. Cascade Working with Several Thermion Amplifiers in Series. Combination of Cascade Working with Reaction Principle to Give Highly Sensitive Receivers. E. H. Armstrong's Methods of Connection. Arrangement of Thermionic Amplifiers in Cascade for Audio-Magnification.—7. The Three-Electrode Thermion as Detector for Continuous Oscillations. Theory of Heterodyne or Beat Reception. Explanation of Production of "Beats." Use of Three-Electrode Thermion as Generator in Beat Reception. Methods of H. J. Round for Beat Reception. Selectivity of the Arrangement. Arrangement of Circuits, by E. H. Armstrong, for Beat Reception. J. J. Hogan's Circuits for Heterodyne Reception with the Aid of the Thermion Oscillator. Hints for the Practical Working of Thermionic Beat-Reception Arrangements.—8. Use of the Thermionic Valve as a Current-Limiting Device to Reduce Atmospheric Disturbances. Methods of Reception Based on Balanced Valve or Crystal Detectors. Elimination of Loud Telephone Noises Due to Atmospherics by Balanced Valve Working. Current-Limiting Methods Employing the Thermionic Valve. Methods of G. M. Wright. Arrangements of E. H. Armstrong for Eliminating Atmospheric Disturbances in Continuous Wave Reception with Thermionic Amplifiers.

CHAPTER VI.

THE THERMIONIC OSCILLATOR AND DETECTOR IN RADIO-TELEPHONY 210

1. The Principles of Radiotelephony. Physical Characteristics of Human Speech. Consonant and Vowel Sounds. The Nature of the Vibrations of a Telephone Diaphragm.—2. The Production of the Undamped Oscillations in the Aerial Wire Necessary for Effecting Radiotelephony and Variation of Amplitude by a Microphone.—3. The Special Advantages of a Thermionic Oscillator for this Purpose. Proper Form and Possible Improvements in the Thermionic Generator.—4. Details of Circuits for Thermionic Transmitters in Radiotelephony. Methods of H. J. Round. Special Advantages of "Soft" Valves for this Purpose. Thermionic Transmitters for Radiotelephony Employing Two Valves or Thermions. The Mode of Controlling the Amplitude of the Oscillations by a Microphone. Marconi-Round Apparatus for Radiotelephony.—5. The Application of the Dynatron in Radiotelephony as a Generator of Undamped Oscillations. The Pliodynatron as a Microphone-

Controlled Generator for Radiotelephony. Practical Achievements With It.—6. Methods of Employing a Plotron as Controller of the Amplitude of Undamped Oscillations Created by an Alternator or Arc Generator. Various Types of Plotron Generator for Continuous Oscillations and Mode of Using in Radiotelephony. Complete Plotron Apparatus for Radiotelephony, and Practical Applications of It.

CHAPTER VII.

RECENT IMPROVEMENTS IN THERMIONIC APPARATUS 222

1. Improvements in Thermionic Apparatus during the European War, 1914-1918. Various Types of Thermionic Valve or Amplifier. Advantages of Very Hard Valves. Effect of Variations of Form and Kind of Grid. The Two Principal Characteristic Curves. Practical Precautions Necessary in the Working of Thermionic Valves.—2. Cascade Working of Valves. Types of Amplifying Valve and Arrangements in the Marconi Company's Valve Receiver Sets. Schemes of Connection.—3. Reactive Coupling of Valves. Various Modes of Valve Coupling Employed for the Reception of Damped or of C.W. Signals. Schemes of Connection in Practical Use.—4. Valve Reception in C.W. Systems. The Oscillating Thermion has Rendered Practical the Heterodyne System of C.W. Reception. Various Arrangements of Circuits employed in C.W. Reception.—5. Recent Advances in the Theory of Thermionic Amplifiers. Investigations of G. Vallauri, H. J. Van der Bijl, J. M. Miller, and Stuart Ballantine. Definition of the Terms Amplifying Factor and Valve Resistance. Methods of Practical Measurement of Amplifying Factor and Valve Resistance due to J. M. Miller. Van der Bijl's Theory of the Amplifier. Delineation of Valve Diagrams showing Characteristic Curves, Amplifying Factors, and Internal Resistances in Terms of Plate Voltage and other Variables. Conclusion.

APPENDIX.

THE TEXT of the Judgments of His Honour Judge Julius M. Mayer and of the United States Circuit Court of Appeals on the Valve Patents 256

EXTRACT from the Judgment of Mr. Justice Sargant in the matter of Fleming's Patent No. 24850 of 1904 274

INDEX 275

THE THERMIONIC VALVE AND ITS DEVELOPMENTS IN RADIOTELEGRAPHY AND TELEPHONY

CHAPTER I.

HISTORICAL INTRODUCTION.

1. The thermionic valve and its various derivatives, such as the three-electrode amplifier and also the thermionic oscillation generator, have become such valuable appliances in wireless telegraphy that it would seem to be an advantage to collect into a single volume a brief summary of knowledge and practice connected with them for the assistance of practical radiotelegraphists. An additional reason for endeavouring to present an unsophisticated description of the nature and mode of operation of these radiotelegraphic instruments is that much which has been written on the subject, especially in patent specifications, has had the effect of obscuring rather than elucidating the true scientific facts connected with the operation of this type of detector or generator.

Small modifications of the original instruments have been christened, especially in the United States, by many strange and fanciful names, and a vocabulary has been developed which makes it difficult for the uninitiated to discern the physical principles involved, although it may have some advantages in inducing Patent Office Examiners to accept as fresh contributions to invention implements or arrangements destitute of real novelty.

The statement of the various stages by which inventors have produced appliances of great sensitivity for the detection of electromagnetic waves forms a fascinating chapter in the history of electrotechnics. Although Maxwell

enunciated in 1865 his great epoch-making theory that electromagnetic effects must be propagated through dielectrics as a wave motion, and surmised that such electromagnetic radiation was identical in nature with light, the acceptance of his views was retarded by the want of experimental proof that such waves could be created and detected by purely electromagnetic methods. Hertz's invention of the ring resonator with micro-spark gap supplied the first means of detecting these space waves, which G. F. Fitzgerald had previously suggested might be created by the oscillatory discharge of a Leyden jar. The employment of Maxwell's electromagnetic waves to effect radiotelegraphy, involving the propagation of such waves over distances reckoned in miles, was fundamentally dependent on Marconi's key invention of the aerial wire or antenna, but it necessitated as well the possession of far more sensitive and certain means of detecting these waves than the ring resonator of Hertz.

In radiotelegraphy we make use of electromagnetic waves propagated over the earth's surface to set up in a receiving aerial wire feeble electric oscillations which are a copy on a very reduced scale of the strong oscillations created in the sending aerial wire. In modern radiotelegraphy the oscillations are generated in the aeri-als either continuously or else in uniformly time-spaced trains, the train or group frequency agreeing with that frequency for which the Bell telephone receiver, acting on the human ear, is most sensitive—viz., about 300-500 per second. These oscillations are then cut up into short and long periods or groups of trains to create the Morse-code signals.

In the ordinary language of wireless telegraphy we call any instrument a *detector* which is employed to detect or make evident by audible or visible means these groups or intermittencies of very feeble electric oscillations in the receiving aerial wire and associated circuits which convey the intelligible signals.

The signal-making instrument may be some form of telegraphic printer, such as the Kelvin syphon recorder or the Morse inker, or the more sensitive Einthoven galvanometer with photographic tape record. On the other hand it may be a Bell telephone receiver, making an audible sound and appealing therefore directly to the ear. In

any case the detector plays an intermediary part. It is operated upon by the feeble oscillations in the receiving aerial, and in turn it acts upon and operates the signal-making instrument.

2. If we leave out of account certain not very sensitive types of detector, such as the thermo-electric, the electro-dynamic or the vacuum tube, which have important uses in the laboratory, but are not sufficiently sensitive for radiotelegraphic work, we may say that five great types of detectors have so far been employed in radiotelegraphy.

These are, *first*, the imperfect contact or coherer type. Starting with the early forms invented by Branly and Lodge, and others, we have as the best representative of this class the nickel-silver filings coherer of Marconi.

The imperfect contact detectors are divisible into two sub-classes—viz., those which require tapping or moving to continually restore them to the sensitive condition, and those that are self-readjusting. The Marconi coherer is one of the first kind, and the Italian Navy carbon-mercury or Castelli coherer, and also the Walter tantalum-mercury coherer, represent the second or automatic sub-class.

In spite of the fact that the Marconi coherer did splendid service for at least five years in establishing radiotelegraphy on a practical basis, these contact detectors have all gone out of use at present. The numerous and delicate adjustments required in the tapper, relay, and Morse inker to obtain the best results, and the too ready response of the detector to atmospheric discharges, or to disturbances from the neighbouring transmitter and consequent variable sensitiveness, combined to bring about its antiquation and retirement from active service.

The *second* type of detectors comprises the magnetic detectors. Developed originally by Rutherford, E. Wilson and Marconi, we find again that the best practical representative of this type is the rotating iron band magnetic detector of Marconi.

This last detector employs a telephone receiver as the signal-making instrument. It has many virtues. It is robust, self-contained, and contains no supplementary or local battery. It is not put out of adjustment by atmospheric discharges or oscillations set up by the near-by transmitter. It is more constant in operation than the

THE THERMIONIC VALVE IN

capricious coherer, but it is not one of the most sensitive detectors. Nevertheless, for military or ship work it is still much valued, although not very light in weight.

The *third* class of detector comprises the electrolytic detectors in which the electrical oscillations to be detected are caused to alter the conductivity of an electrolytic cell by varying the ionic films on the electrodes. These detectors have never come into very extensive use in Great Britain.

The *fourth* type of detector, and until lately probably the most extensively used, are the rectifying contact or crystal detectors. Starting with Dunwoody's discovery of the rectifying property of certain crystals of carborundum and with the discoveries of Pickard and G. W. Pierce on the rectifying power of contacts between crystals of zincite and chalcopyrite and molybdenite and copper, there has been an immense amount of research on this type of detector, which depends either upon a true unilateral conductivity in the mass or at the contact or else upon sudden changes in curvature in the volt-ampere or characteristic curve.

The simplest mode of use of such crystal detectors is as rectifiers of the oscillation trains into gushes of electricity in the same direction, thus enabling trains of electrical oscillations to affect a telephone receiver. These detectors are rather easily put out of adjustment by strong atmospheric discharges, or by strong oscillations set up by the proximity of the transmitter. They therefore require somewhat frequent readjustment of contact to obtain the best results. Nevertheless, their sensitiveness, simplicity and cheapness made them very quickly a favourite detector. Their introduction was followed at once by an outburst of irresponsible radiotelegraphy at the hands of innumerable electrical amateurs and students which required the firm intervention of National and International legislation to keep it within bounds of reason and safety.

The *fifth* class of detector comprises those to the consideration of which this book is limited—viz., the thermionic detectors. These depend ultimately upon the emission from incandescent bodies of ions or electrons. They are or can be made highly sensitive and yet are not affected injuriously by atmospherics or by neighbouring electric sparks. They are easy of adjustment and always ready for use. The original of all these detectors is the now well-known Fleming

Valve. They have the remarkable property that they can be employed as generators of oscillations as well as detectors and have important uses as telephone repeaters and ordinary telegraph relays, in addition to services in wireless telegraphy. Hence their properties, construction and use have been widely studied, and we may without risk of contradiction call them the master weapon of the radiotelegraphist.

3. It will be advisable to begin the study of these thermionic detectors by a short historical sketch of certain investigations and their results. About 1880 Mr. Edison completed his solution of the problem of domestic electric lighting by giving to the world the carbonised bamboo filament incandescent electric glow lamp, and Sir Joseph Swan, aided by Mr. C. H. Stearn, had evolved the parchmentised cotton thread lamp on similar lines. This simple appliance, consisting of an hermetically closed and highly exhausted glass bulb, having in it a carbon filament welded to terminal platinum wires sealed through the glass, solved the problem of "dividing the electric light" which had engaged the attention of numerous inventors for a quarter of a century. In the early part of 1882 the public had the opportunity of seeing at the first Crystal Palace Electrical Exhibition incandescent lighting on a large scale. The author of this book was at the beginning of that year appointed scientific adviser to the Edison Electric Light Company of London, formed to operate Edison's inventions in Great Britain, and came therefore into a position to investigate carefully some of the problems connected with the physics of the incandescent lamp.

It was soon found that, apart from accidents, such lamps had a certain "life." The slightest inequality in resistance of parts of the filament caused unequal production of heat, and any minute crack or flaw in the filament caused local superheating at that point and hence an excessive rise of temperature.

Even if the filament was extremely uniform there appeared to be a slow volatilisation of the carbon, which in time blackened the inside of the bulb and reduced the candle power of the lamp.

Before long the author's attention was drawn to the fact that when a defect appeared at some point in the carbon filament on one "leg" of the horseshoe carbon, which caused

THE THERMIONIC VALVE IN

a great rise of temperature at that point, the blackening of the interior of the bulb was less or absent along a certain line in such fashion as to show that the scattered carbon molecules had been shot off in straight lines from the point of excessive heating. Thus was formed what the author

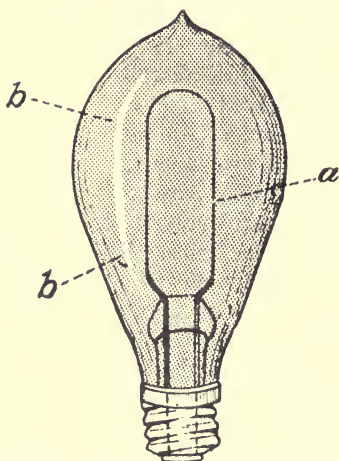

FIG. 1.—Incandescent Electric Lamp, showing the glass bulb blackened by the deposit of carbon or metal due to molecular scattering from point *a* on the filament, a shadow line of no deposit being formed at *b*, due to shielding effect of one leg of the horseshoe filament.

termed *a molecular shadow* on the bulb (see Fig. 1). If, for instance, a scent-sprayer is filled with ink and the spray blown on to a sheet of paper the latter will be darkened uniformly by minute drops of ink spray. If, however, a wire or rod is held in the path of the spray the paper will be protected from blackening along a region which corresponds to the shadow of the rod (see Fig. 2). Hence when we find in old carbon filament incandescent lamps a horseshoe filament broken at one spot and the bulb darkened all over the inside with the exception of a white or un-darkened line on the bulb

corresponding to the shadow of the unbroken part of the filament relatively to the point of rupture or overheating we can conclude that the chief part of the scattering of the carbon particles has taken place in straight lines proceeding from the point in the filament at which it has ultimately burnt through. This phenomenon of "molecular shadows" in incandescent lamps was described by the author in two papers read to the Physical Society of London in 1883 and 1885.¹

This effect clearly showed that from the incandescent

¹ See *Proc. Phys. Soc. Lond.*, vol. v., p. 283, 1883, "On a Phenomenon of Molecular Radiation in Incandescent Lamps," by J. A. Fleming; also *Proc. Phys. Soc. Lond.*, vol. vii., p. 178, 1885, "On Molecular Shadows in Incandescent Lamps," by J. A. Fleming.

filament there was a projection of matter in straight lines which was deposited on the interior of the bulb, except in those parts shielded by the "shadow" of the rest of the filament, thus leaving a white or unblackened line. This effect is obviously due to the fact that the residual air in the bulb is at such a rarefied condition that the mean free path of a molecule is comparable in length with the diameter of the bulb.

In air at ordinary temperature and pressure the mean free path of an oxygen or nitrogen molecule is about four one-millionths of an inch, but when the pressure is reduced in a bulb to one-millionth of an atmosphere it becomes increased to about

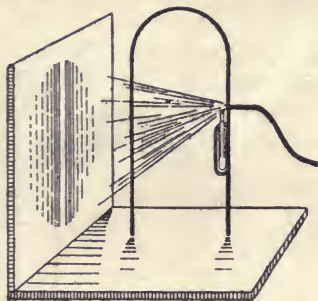

FIG. 2.—A "spray shadow" of a rod thrown on a cardboard screen by ink spray to illustrate the mode of formation of a molecular shadow in a glow lamp.

four inches. This means that a molecule of carbon projected in any way from the filament might travel on an average four inches before colliding with other residual air molecules and being deflected from its path.

The next important observation on this subject was made by Mr. Edison in 1883.¹ He was apparently examining the phenomena involved when carbon filament lamps are running at a high efficiency, and for that purpose he

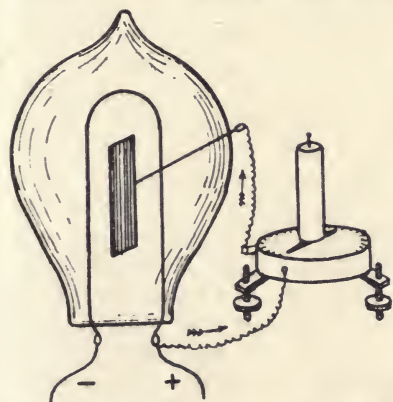

FIG. 3.—Incandescent Lamp with a Metal Plate sealed into the bulb and a galvanometer connected between the terminal of the plate and positive terminal of the filament to show the "Edison effect."

sealed into the bulb of a glow lamp a metal plate placed between the legs of the horseshoe-shaped carbon filament, the

¹ See *Engineering*, December 12th, 1884, p. 553.

plate being carried on an insulated wire sealed through the bulb (see Fig. 3). He found that, when the filament was rendered incandescent by a direct current of electricity, a galvanometer connected between the middle plate and the positive terminal of the filament indicated a current of a few milliamperes, but little or no current when connected between the negative terminal and the middle plate (see Fig. 4). He did not furnish any explanation of this effect

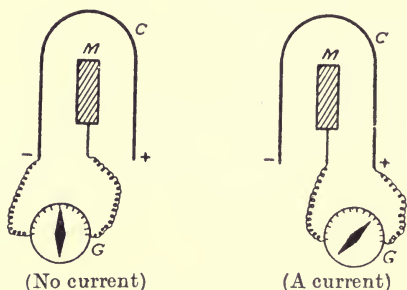

FIG. 4.—Mode of connection of the galvanometer, *G*, to metal plate, *M*, and to the terminals of the carbon filament of the lamp (+ and -) in the experiment of the "Edison effect."

at that time, but it became known then and after as the "Edison effect" in glow lamps.

Mr. Edison gave to Sir William Preece in October, 1884, certain incandescent lamps made with metal plates sealed into their bulbs or into tubular extensions of them, and in the following year, in March, 1885, Preece described to

the Royal Society of London experiments which he had made with these lamps.¹ Preece made quantitative measurements of the current flowing through the galvanometer when connected in between the positive terminal of the carbon filament and the middle plate at various voltages applied to the filament. He found that this current was independent of the nature of the metal of which the middle plate was made, but that it increased very rapidly with increase in the potential difference of the filament terminals. He found that for a given lamp voltage the Edison effect varied with the position of the plate in the bulb, but that it was still sensible when this plate was placed at the closed end of a tube opening out of the bulb, provided this tube was straight, but the current was found to vanish if that side tube was bent up at right angles (see Figs. 5 and 6).

¹ See *Proc. Roy. Soc. Lond.*, vol. xxxviii., p. 219, 1885, "On a Peculiar Behaviour of Glow Lamps when Raised to High Incandescence," by W. H. Preece.

Preece considered that this Edison effect was connected with the discharge or projection of carbon molecules or particles from the filament in straight lines, but he gave

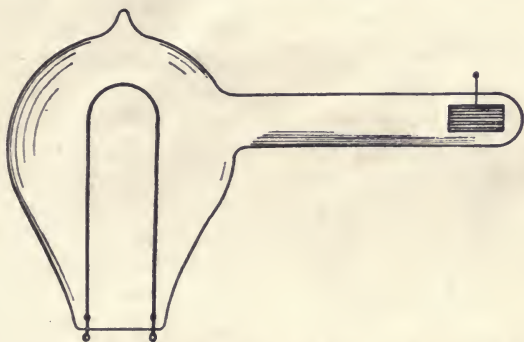

FIG. 5.—Collecting Plate placed at the end of a side tube opening out of the bulb of an incandescent lamp.

no full theory of the phenomenon, nor did he make any application of the facts. A year or two later the author of this book took up the investigation, being convinced that much yet remained to be discovered about it which had not been unravelled by Edison or Preece.

A number of special carbon filament glow lamps with middle plates were made for the author at the Lamp Factory of the Edison and Swan United Electric Light Company and researches were

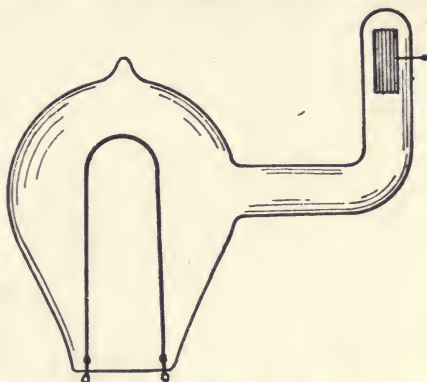

FIG. 6.—Collecting Plate placed at the end of an elbow tube opening out of the bulb of an incandescent lamp.

begun with them, and the results communicated to the Royal Society of London in 1889.¹ and in a Friday evening

¹ See *Proc. Roy. Soc. Lond.*, vol. xlvii., p. 118, 1890, "On Electric Discharge between Electrodes at Different Temperatures in Air and in High Vacua," by J. A. Fleming.

THE THERMIONIC VALVE IN

discourse on February 14th, 1890, to the Royal Institution.¹

One of the first new facts the author discovered was that the "Edison effect" was greatly diminished or entirely annulled by surrounding the negative leg of the carbon filament by a glass or metal tube, or by interposing a mica shield between the negative leg of the horseshoe-shaped carbon filament and that side of the middle or insulated plate facing the negative leg (see Figs. 7, 8 and 9). By negative leg is meant that side of the carbon horseshoe loop in connection with the negative pole of the battery which heats the filament. It was not annulled or much diminished

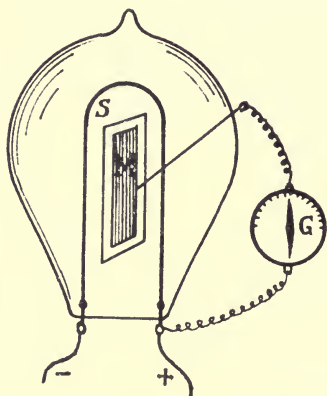

FIG. 7.—Incandescent Lamp having a mica shield placed between the metal plate, *M*, and the negative leg of carbon loop filament, thereby diminishing the "Edison effect."

when the tube surrounded the positive leg.

The author confirmed Preece's observation that the effect

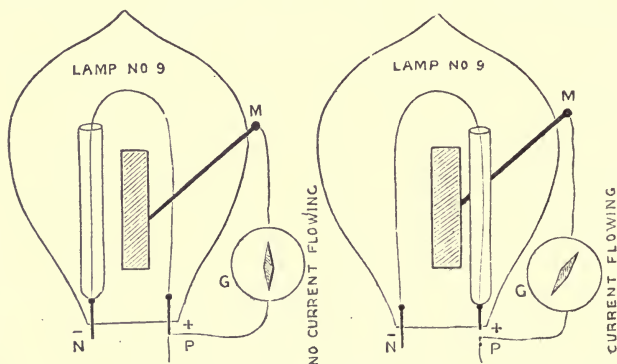

FIG. 8.—Glass or Metal Tube surrounding one leg of horseshoe carbon filament in a glow lamp to show the annulment of the "Edison effect" when it surrounds the negative leg.

¹ "Problems in the Physics of an Electric Lamp," *Proceedings of the Royal Institution*, February 14th, 1890.

was still visible when the collecting plate was placed at the end of a long straight tube opening into the bulb, but disappeared when the plate was placed at the end of a tube bent at right angles (see Figs. 10 and 11). The next fact discovered by the author was that a charged electric conductor or electric condenser if charged with positive electricity is instantly discharged when connected to the middle plate when the lamp filament is incandescent. If, however, the conductor or condenser is charged with negative electricity, then it is not in the least discharged by so connecting. On the contrary, it will be charged negatively by the incandescent filament.

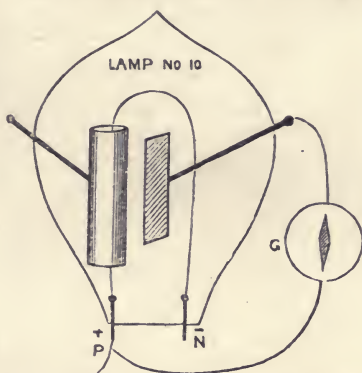

FIG. 9.—Incandescent Lamp with horseshoe carbon filament and metal cylinder surrounding one leg of filament to show the "Edison effect."

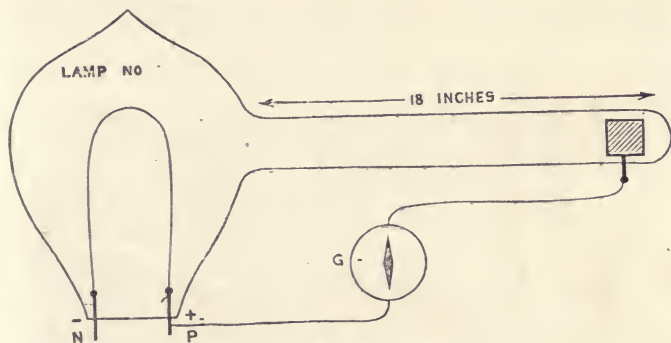

FIG. 10.

This fact may be most clearly proved by the following experiment. Connect a gold-leaf electroscope to the middle plate of the lamp, the filament being cold. Then charge the electroscope with positive electricity by means of a rubbed glass rod. Next, switch on the lamp and incandesce

THE THERMIONIC VALVE IN

the filament. The electroscope instantly loses its positive charge. Then repeat the experiment, charging the gold leaves negatively

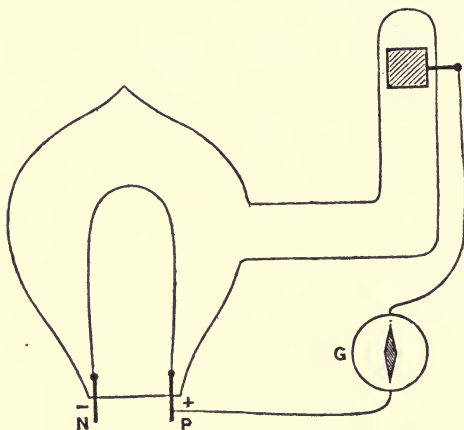

FIG. 11.

by means of a rod of sealing wax, and it will be found that switching on the lamp does not discharge the electroscope. These experiments show that the incandescent filament is giving off negative electricity in some manner.

The next experiment was arranged to prove that the space between the incandescent filament and the middle plate was conductive for negative

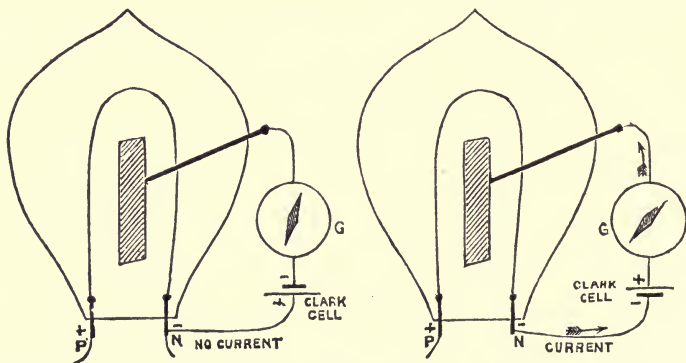

FIG. 12.—Incandescent Lamp with metal plate in the bulb and galvanometer, *G*, connecting plate and negative terminal. Clark cell inserted in plate circuit to show the escape of negative electricity from the incandescent filament.

electricity from the filament to the plate, but not in the opposite direction. For this purpose a single cell of a battery was joined in series with a galvanometer and one

terminal attached to the middle plate and the other (the negative) terminal of the battery to the filament (see Fig. 12). A current then flowed through the vacuous space between the filament and the plate under this feeble E.M.F. of about 1.5 volts. If, however, the battery was reversed no current flowed.

A variation of this experiment was then arranged as follows :

A lamp was constructed, having four horseshoe carbon filaments in it, two at each end (see Fig. 13). These pairs

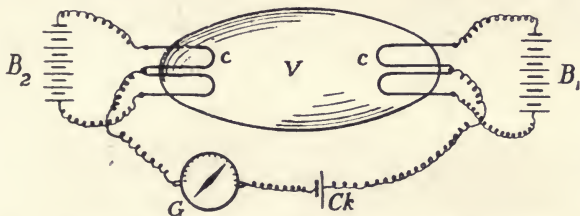

FIG. 13.—Exhausted Glass Bulb having terminal electrodes formed of carbon filaments kept incandescent by separate batteries to show the conductivity of a highly rarefied gas for currents of electricity under low electromotive force with an incandescent cathode.

could be joined in series outside the bulb, and each pair incandesced by its own insulated battery. When both sets of filaments were cold a small E.M.F., such as 8 or 10 volts or so, or even 100, would not send any measurable current across the vacuous space. If, however, the filaments at one end were made incandescent, then even a single cell can send a current of a milliampere or so through the vacuous space provided that this cell has its negative terminal in connection with that carbon filament which is incandescent. This fact had previously been discovered in another way by W. Hittorf¹—viz., that through a vacuum tube a very small E.M.F. will send a measurable current, provided the cathode terminal of the vacuum tube is incandescent or at a high temperature.

The author then discovered that the same effects exist in the case of the electric arc.

¹ See *Annalen der Physik*, vo. xxi., p. 90, 1884; see also *Physical Memoirs*, vol. i., p. 180, issued by the Physical Society of London, W. Hittorf, "On Conduction of Electricity in Gases."

THE THERMIONIC VALVE IN

If a direct current electric arc of some length is formed between carbon electrodes, and if a third carbon electrode is so placed as just to dip into the flame of the arc,

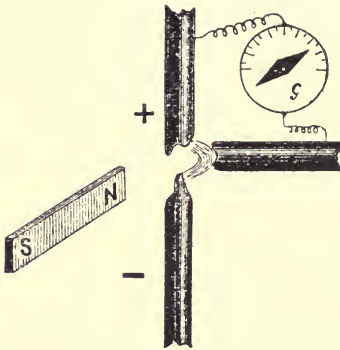

FIG. 14.—An electric arc projected by means of a magnet against a third carbon to show the "Edison effect" in the case of an electric arc.

is so placed as just to dip into the flame of the arc, or if the arc is deflected against it by a magnet, it will be found that a galvanometer or ammeter connected between the positive carbon and the third or lateral carbon indicates a current which may even be strong enough to ring an electric bell. If, however, the ammeter or bell is connected between the negative carbon of the arc and the middle

carbon, then no current passes (see Fig. 14).

Also, it can be shown by the same means that the space between the negative carbon of the arc and the middle carbon possesses a unilateral conductivity and will permit negative electricity from a battery to pass from this negative carbon to the middle carbon, but not in the opposite direction (see Fig. 15).

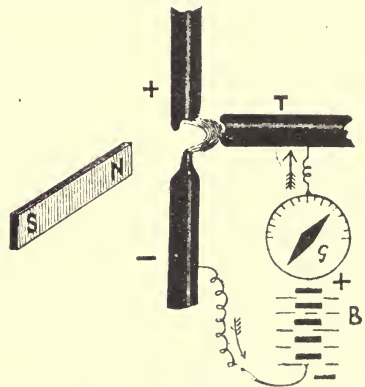

FIG. 15.—An experiment with the electric arc having a third carbon to show that a current of negative electricity can pass under low E.M.F. between the negative terminal of the arc and the third carbon electrode.

Finally, the author discovered that the same phenomenon can be demonstrated in the air at ordinary pressure. For if a thick carbon filament is rendered incandescent in air by passing a strong current through it, and if an insulated metal plate is held near to it, a galvanometer joined in between this metal

plate and the positive terminal of the carbon indicates a small current, but no current if joined in between the middle plate and the negative terminal of the carbon loop (see Fig. 16).

These same effects were the subject of a more extended investigation by the author, the results of which were communicated to the Physical Society of London in 1896, entitled, "A Further Examination of the Edison Effect in Glow Lamps."¹ In this research quantitative measurements were given showing the relation between the Edison effect current—that is, the current through a galvanometer connected between the collecting plate and the positive terminal of the lamp filament and the working voltage of the lamp or potential difference of the ends of the filament.

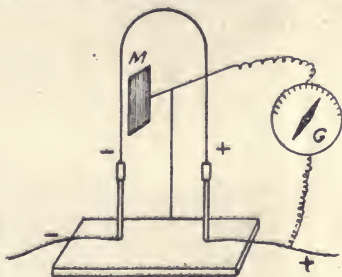

FIG. 16.—An experiment showing the "Edison effect" with a carbon filament rendered incandescent in the open air.

The curve delineating this ratio rises very steeply as the P.D. on the terminals of the filament (called the lamp voltage) increases (see Fig. 17).

The table below gives the results of one set of measurements which are represented graphically in Fig. 17 :

| Lamp Voltage. | Thermionic Current in Milliampères. | Lamp Voltage. | Thermionic Current in Milliampères. |
|---------------|-------------------------------------|---------------|-------------------------------------|
| 30 | 0.085 | 38 | 2.36 |
| 32 | 0.190 | 39 | 2.71 |
| 33 | 0.44 | 40 | 2.99 |
| 34 | 0.84 | 41 | 3.37 |
| 35 | 1.23 | 42 | 3.71 |
| 36 | 1.69 | 43 | 3.99 |
| 37 | 2.01 | 44 | 4.25 |

The galvanometer used to measure the current had a resistance of 6,372 ohms.

It will be seen that the thermionic current through

¹ See *Philosophical Magazine*, July, 1896; also *Proc. Phys. Soc. Lond.*, vol. xiv., p. 187, 1896.

THE THERMIONIC VALVE IN

the galvanometer, when connected between the collecting plate and the positive terminal of the filament, rises to several milliamperes in value. If the galvanometer is

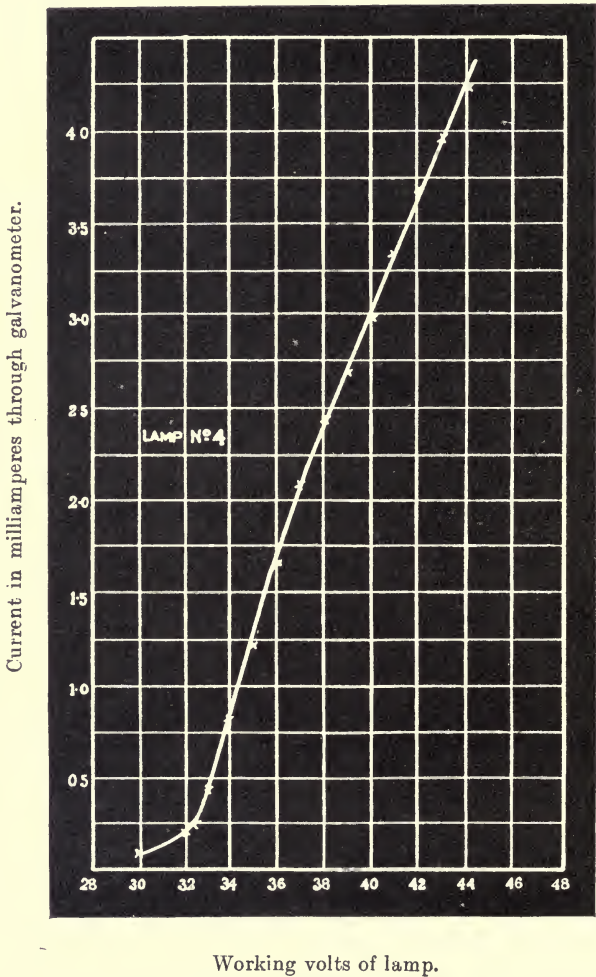

FIG. 17.

connected between the collecting plate and the negative terminal only a very small current of, perhaps, less than

·001 of a milliampere is found in the case of carbon filament lamps, but this current increases rapidly as the lamp voltage is raised just as does the thermionic current between the collecting plate and the positive lamp terminal. One very curious fact was soon discovered—viz., that the thermionic current may jump suddenly from one value to a much higher one, even though the lamp voltage or P.D. of ends of the filament is kept perfectly constant.

This is shown by the curve in Fig. 18, which delineates the result of one set of measurements of the thermionic current of a carbon filament lamp, with horseshoe-shaped filament, and collecting plate placed midway between the legs, as in Fig. 3.

Another set of observations were made with an electrostatic voltmeter which had its terminals connected respectively to the collecting plate and to the positive terminal of the lamp. It was found in all cases, when the filament of carbon was brought to full incandescence corresponding to 3·5 watts per candle-power, that the metal collecting plate was brought down to the potential of the negative terminal of the lamp so that the P.D. between the collecting plate and positive terminal of the filament was the same, or nearly the same, as the working voltage on the filament. Later observations made with lamps with tungsten wire filaments showed that the collecting plate may even be of rather lower potential than the negative terminal of the lamp, and hence a galvanometer joined in between the collecting plate and the negative lamp terminal may indicate in these cases a certain small current.

Finally, the author tried some experiments with a vacuum incandescent lamp having a filament made of platinum wire, and proved that the same effects exist as in the case of a carbon filament, though less in degree. The result of all the research work, therefore, conducted on this matter between 1883 and 1896 had made it perfectly clear that in the case of a carbon filament glow lamp, and also of an incandescent metallic wire, there is a projection of atoms, or molecules, from the incandescent filament, and also a projection of negative electricity as well.

4. Before considering the explanation which modern electrical theory gives of the above-mentioned facts with

THE THERMIONIC VALVE IN

regard to the incandescent lamp, we must briefly review certain earlier researches in connection with the loss of electricity from incandescent bodies.

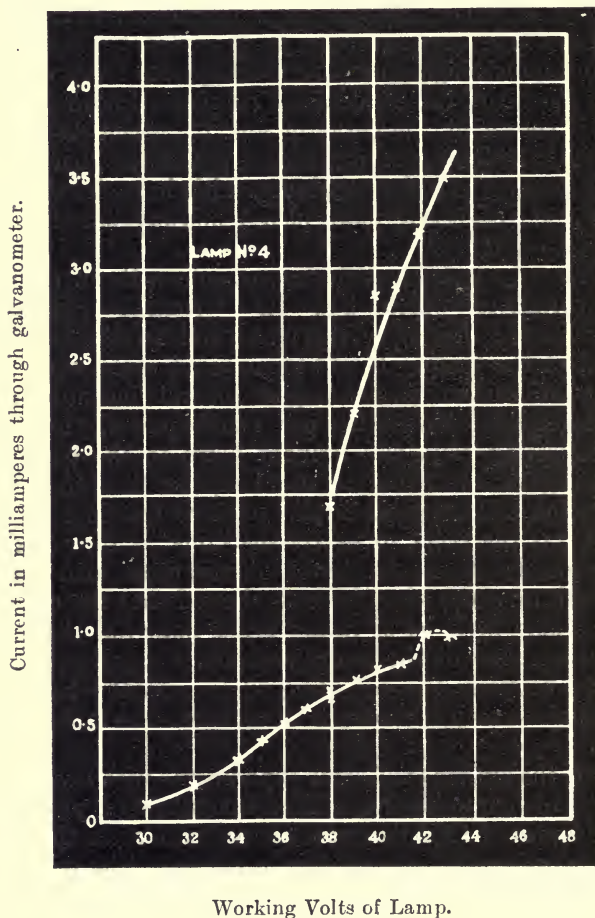

FIG. 18.

It had become known to the investigators of electrical phenomena in the middle of the eighteenth century that heat and flame cause a leakage of electricity from charged conductors.

In more modern times Becquerel discovered in 1853 that air at a temperature of about 1500° C. would conduct electricity even under an E.M.F. of a very few volts, and this was confirmed by Blondlot in 1881 and 1887.

An important discovery was, however, made by F. Guthrie in 1873.¹ He first found that at a *red* heat an insulated iron ball could retain a charge of negative electricity but not a charge of positive.

At a *white* heat it could retain neither a positive nor a negative charge.

From certain measurements given by him we may roughly estimate that at temperatures between about 750° C. and 1000° C. an iron ball rapidly loses a charge of positive electricity, and at 1200° C. or 1300° C. and above it immediately loses either a positive or negative charge. Guthrie also showed that a platinum wire spiral heated to a dull red heat by an electric current rapidly discharged a gold leaf electroscope which had been given a negative charge when held near it. If the said platinum wire was heated white hot it discharged the electroscope whether the latter was charged positively or negatively.

The same experiment can be carried out with an iron poker the tip of which is heated to a very bright red heat in a blacksmith's forge. The red hot poker discharges immediately a gold leaf electroscope which has received a negative charge of electricity, but does not discharge it if it has received a positive charge, when held near to it.

These researches were continued about the year 1880 on rather different lines by Elster and Geitel, and their method consisted in heating by an electric current either a metallic wire or a carbon filament included in a glass vessel which could be exhausted or filled with different gases. Near this heated filament was fixed a metal plate carried on a wire sealed through the glass (see Fig. 19). This plate was connected to an electroscope. It was found that the plate became charged to a certain potential when the wire was heated.

Generally speaking, it was found by Elster and Geitel that a metallic wire gave off positive electricity at a temperature near or below a red heat, but at higher temperatures it evolved negative electricity, which increased rapidly in

¹ See *Phil. Mag.*, 4th Series, vol. xlvi., p. 257, 1873, "On a Relation between Heat and Static Electricity."

quantity as the temperature was raised, and therefore gave a negative charge to the insulated plate. Carbon filaments, however, were found to give off negative electricity at all temperatures.

As some references later on will be made to the published papers of Elster and Geitel we give here the titles (in English) and references to the principal papers which concern us in this subject.

(1) "On the Electricity of Flames," *Wiedemann's Annalen*, vol. xvi., p. 193 (1882).

(2) "On the Generation of Electricity by the Contact of Gases and Incandescent Bodies," *Wied. Ann.*, vol. xix., p. 588 (1883).

(3) "On the Unipolar Conductivity of Heated Gases," *Wied. Ann.*, vol. xxvi., p. 1 (1885).

This paper deals with the unsymmetrical conductivity of flames.

(4) "On the Electrification of Rarefied Gases and Electrically Heated Wires," *Wied. Ann.*, vol. xxxi., p. 109 (1887).

In this paper Elster and Geitel describe experiments made with an exhausted glass bulb having stretched across it a platinum wire which could be heated electrically. Above the wire was a metal plate carried on a platinum wire sealed through the glass (see Fig. 19). The bulb could be exhausted or filled with various

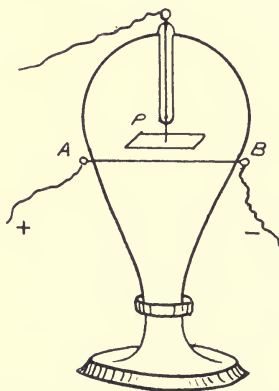

FIG. 19.—Exhausted bulb with incandescent wire, *AB*, in it, and metal plate, *P*, used by Elster and Geitel to show the emission of electricity from incandescent wires.

gases. There is no mention of the use of a carbon filament.

(5) "On the Generation of Electricity by Contact of Rarefied Gas and Electrically Heated Wires," *Wied. Ann.*, vol. xxxvii., p. 319 (1889).

In this paper (dated March, 1889) Elster and Geitel mention the unilateral conductivity for direct currents of rarefied gases in tubes with one hot and one cold electrode.

They employed for some experiments a carbon filament lamp with a plate sealed into the bulb, and mention that the filament emits negative electricity. There is no mention of the use of such a tube or lamp for rectification of alternating currents.

This last paper of Elster and Geitel was only published a few months before the paper sent (in December, 1889) by the author to the Royal Society, to which reference has already been made.

The work of Elster and Geitel was purely scientific and had no technical application for the rectification of alternating currents or the use for any practical purpose of a carbon filament vacuum lamp having a metal plate sealed into the bulb.

5. One characteristic of all the investigations on this subject, as above mentioned, was that none of their authors had been able to put forward any satisfactory explanation of the facts thus discovered. The ordinary two-fluid or single-fluid theory of electricity and likewise Maxwell's electromagnetic theory failed to give any reasons for these striking differences between the behaviour of positive and negative charges on hot bodies.

In 1897 Sir J. J. Thomson made the first publication of the remarkable investigations which enabled him to demonstrate that negative electricity is always associated with masses at least 1,800 times smaller than the mass of an atom of hydrogen and that under certain conditions these electric corpuscles are emitted from hot bodies.

Faraday long ago proved that in the electrolysis of liquid conductors the passage of a certain quantity of electricity through the liquid is always accompanied by the movement to, or liberation upon, the electrodes of a fixed quantity of matter or products of decomposition of the electrolyte.

It was then and after recognised that electricity is conveyed through electrolytes only in association with atoms, or groups of atoms, called *ions*, in a fixed ratio, and that every such ion carries with it an electric charge which is an exact integer multiple of a certain unit charge.

In the case of the hydrogen atom or ion resulting from the passage of electricity through aqueous solutions of salts the quantity of electricity carried by the whole number of atoms of hydrogen which together weigh 1 gram (called the gram-

THE THERMIONIC VALVE IN

atom of hydrogen) is 96,500 coulombs, or very close to it. Hence, since one coulomb is equal to one-tenth of an electromagnetic unit (E.M.U.) of electrical quantity, we can say that for the hydrogen ion or atom, the weight of which is taken as unity, the ratio of charge (e) to mass (m) is 9,650.

According to Faraday's Law of Electrolysis the same quantity of electricity passed through various electrolytic cells will liberate on the electrodes masses of ions which are in the ratio of the chemical equivalents of these substances.

Exhaustive experiments have shown that a current of one ampere flowing for one second—that is, one coulomb—deposits in a silver voltameter 0.001118 gram of silver on the cathode. The atomic weight of silver is 108 and its valency is unity. Hence 108 is its chemical equivalent, that of hydrogen being unity. Accordingly a current of one ampere liberates from a water voltameter in one second a mass of hydrogen equal to 0.00001035 gram. In other words, 96,500 coulombs, or 9,650 E.M.U. of electric quantity, liberates one gram of hydrogen and 108 grams of silver at the cathodes of electrolytic cells.

Now 3×10^{10} units of electric quantity in electrostatic measure (E.S.U.) are equivalent to the electromagnetic unit. Accordingly $2895 \times 10^{11} = 3 \times 10^{10} \times 9,650$ E.S.U. will liberate at 0° C. and 760 mm. pressure 11,200 cubic centimetres of hydrogen gas which weighs one gram.

Modern researches on the kinetic theory of gases have shown that in one cubic centimetre of any gas at 0° C. and 760 mm. there are most probably 2.7×10^{19} molecules. As the molecule of hydrogen contains two atoms there are $11,200 \times 5.4 \times 10^{19}$ atoms of H. liberated by the passage of $2,895 \times 10^{11}$ electrostatic units of electricity. Hence each hydrogen ion or atom must be associated with

$$\frac{9,650 \times 3 \times 10^{10}}{11,200 \times 5.4 \times 10^{19}} = 4.77 \times 10^{-10}$$

electrostatic units (E.S.U.) of electric quantity.

This charge of the hydrogen ion is denoted by e and is a negative charge. Hence we have

$$\begin{aligned} e &= 4.77 \times 10^{-10} \text{ electrostatic units.} \\ &= 1.59 \times 10^{-20} \text{ electromagnetic units.} \end{aligned}$$

This very small quantity of electricity is Nature's unit of electricity and it is the quantity of negative electricity

carried by one hydrogen ion in electrolysis. It is therefore a very important unit and was named by Dr. G. Johnstone Stoney in 1891 *an electron*, the importance of such designation having been indicated by him as early as 1874.¹

The mass of a hydrogen atom is 1.662×10^{-24} gram, and therefore the ratio of charge to mass or e/m for the hydrogen ion is 9,650 when e is measured in electromagnetic units.

The study of the phenomena of electrolysis had already convinced some physicists that electricity, like matter, most probably exists in small indivisible units which may be called *atoms of electricity*. The charge of the hydrogen ion is this electric atom or electron, and all ions carry this unit or else some exact integer multiple of it in electrolysis.

6. Meanwhile evidence had been accumulating that in the case of conduction through gases electricity was moved in association with masses or matter of some kind.

The discharge or conduction of electricity through the very rarefied gas in a high vacuum had been shown by Sir William Crookes to be accompanied by the projection of particles from the cathode or negative terminal which had all the properties of material particles in motion. When they impinged on small paddle wheels mounted in the vacuum tube they caused these wheels to rotate and they also produced intense phosphorescence when falling upon certain substances, whilst other solid bodies placed in the path of the discharge cast shadows in their wake.

These particles also behaved as if they carried charges of negative electricity, being deflected by magnetic or electric fields.

Approaching these known effects from a new point of view, Sir J. J. Thomson devised experimental methods of extraordinary ingenuity and power which enabled him to measure the ratio of charge to mass in the case of these cathode ray particles in a high vacuum tube.

It will not be necessary to describe these methods in detail because the reader can obtain all information about them either from Thomson's book, *Conduction of Electricity through Gases* (see chap. v.), or from any advanced text-book on modern physics. Suffice it to say that the method depends upon the deflection of a cathode ray particle from

¹ See *Transactions of the Royal Society of Dublin*, vol. 1., p. 582, 1891; also *Phil. Mag.*, 1881, p. 385.

its path by the simultaneous action of an electric field and a magnetic field at right angles to each other and to the

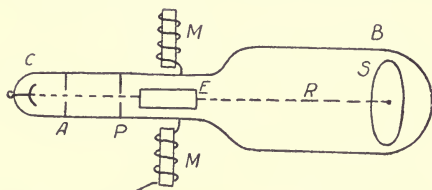

FIG. 20.—Cathode ray tube, having internal deflecting plates, E , and external deflecting magnets, M , and phosphorescent screen, S , to show the deflection of cathode rays by electric or magnetic force.

direction of motion of the particle (see Fig. 20). The charge carried by the cathode particle is denoted by e and its mass by m and the experiments give the ratio e/m where e is measured usually in electromagnetic units. A

brief outline of the theory of the action as given by Sir J. J. Thomson is as follows :

Let a particle of mass m , carrying a charge of electricity e , be moving in a straight line with velocity v , and let a magnetic force H act on it at right angles to its line of motion. Let e be in electrostatic units and H in electromagnetic units. Then the mechanical force acting on the particle is $\mu H e v$, where μ is the magnetic permeability of the medium. Hence if we take the dielectric constant K of the medium to be unity, since $\mu K = 1/c^2$ where $c = 3 \times 10^{10}$, we have the force f acting on the particle given by $H e v / c^2$ and the acceleration $= H e v / m c^2$ and the space moved over in a transverse direction in a time t is $\frac{1}{2} \frac{H e v}{m c^2} t^2$.

Let this displacement be called δ . Then during the same time the particle moves a distance l in the original direction, where $l = vt$. Hence $\delta = \frac{1}{2} \frac{H e v l^2}{m c^2 v^2} = \frac{1}{2} \frac{l^2}{c^2} H \frac{e}{m} \frac{1}{v}$. Now δ , l and H are capable of measurement, and hence $\frac{e}{m} \frac{1}{v} = A$, say, becomes known.

Again, suppose we subject the particle to the action in a transverse direction of an electric force E at right angles to its line of motion. The mechanical force exerted on it is $E e$ and its acceleration is $e E / m$ and its displacement in a time t is

$$\delta^1 = \frac{1}{2} \frac{e E}{m} \left(\frac{l}{v} \right)^2 = \frac{E}{2} l^2 \frac{e}{m} \frac{1}{v^2}$$

Hence, if δ^1 , l and E are measured, we obtain $\frac{e}{m} \cdot \frac{1}{v^2} = B$, say,

If then we adjust matters so that the two displacements δ and δ^1 are equal and observe E , H and l we have $v = A/B$
 $= c^2 \frac{E}{H}$ and $\frac{e}{m} = 2 \frac{c^4}{l^2} \cdot \frac{E}{H^2} \delta$.

If the particle carrying the charge is a cathode ray particle then we can observe the deflections due to the electric and magnetic forces by allowing the particle to strike against a screen covered with phosphorescent material and there causing the appearance of a bright spot of light. The displacement of this spot enables us to measure δ and δ^1 . The details of the apparatus required for this purpose will be found described in Thomson's book *Conduction of Electricity Through Gases*, chap. v., or in his book *The Corpuscular Theory of Matter* (Constable & Co.).

Thomson's most important experimental result was that the ratio e/m was quite independent of the nature of the residual gas in the high vacuum tube and of the material of which the cathode was made. His early numerical measurements were found subsequently to be rather too low, but the measurements being repeated by him and many other physicists have led to the conclusion that for the cathode ray particle the ratio e/m is very nearly 1.77×10^7 when e is measured in electromagnetic units, and is 5.31×10^{17} if e is measured in electrostatic units.

Now this number, 1.77×10^7 , is at once seen to be more than 1,700 times greater than the ratio $e/m = 9,650$ for a hydrogen ion, and the question at once arose, is this due to e being greater or m being less in the case of the cathode particle? To settle this question, Thomson devised other experiments of very great ingenuity, based on the following principles :

If air at ordinary temperature and pressure is saturated with moisture any sudden expansion or enlargement of the vessel containing it, which increases the volume in a ratio of about 5 to 4, will not cause any cloudiness to appear in the vessel, provided the air is quite free from dust. Dust particles act as nuclei for condensation of water-vapour into water particles forming clouds. Hence dust free from air may be cooled by expansion to a certain degree, and

will remain supersaturated with water-vapours uncondensed into cloud.

It was, however, shown by C. T. R. Wilson, in 1897, that gaseous ions in air—that is, atoms or groups of atoms having a positive or negative electric charge—could act like dust particles and cause precipitation of water vapour into white clouds, when the air was suddenly increased in volume in the ratio of not less than 4 to 5, or by about 20 to 25 per cent. It had also been found that Röntgen or X-rays could create gaseous ions in air, and these, like dust particles, have the property of condensing water vapour round them so as to form a cloud of water spherules, when air supersaturated with water and containing gaseous ions is suddenly expanded in volume in about the ratio 5 to 4.

7. J. J. Thomson applied this discovery of C. T. R. Wilson in a highly-remarkable way to determine the electric charge on a gaseous ion produced by the action of X-rays or any other means.

A glass vessel has in it a tightly-fitting piston which can be suddenly displaced so as to expand some air saturated with water vapour. If this air is dust-free and expanded to not more than 1.25 times its original volume, no cloud will be formed.

If the air is ionised by exposing it to Röntgen or X-rays, some of the air molecules will acquire a positive and some a negative charge. These act as nuclei and condense round them water molecules, so that when the air is expanded suddenly a cloud forms in the vessel. If the expansion ratio is between 1.25 and 1.8 only negative ions are caught, and condense water vapour molecules round them. If this cloud is left to itself it subsides in the vessel, because each little droplet of water very slowly falls through the air.

If the radius of each spherical droplet of water is a , and if c is the coefficient of viscosity of the air, then the drop in falling soon attains a final constant velocity, v , which Sir George Stokes had previously proved was given by $v = \frac{2}{9} \frac{a^2}{c} g$, where g is the acceleration of gravity.

The proof of Stokes's formula is rather long, but it is given in Lamb's treatise on *The Motion of Fluids* (chap. ix.,

p. 226), and also in Stokes's original paper in the *Cambridge Philosophical Society's Transactions*, vol. ix., p. 48. Stokes showed that the falling sphere is losing potential energy at a rate $6 \pi a c v^2$, and hence the moving force is $6 \pi a c v$.

But this must also be equal to $\frac{4}{3} \pi a^3 g (\sigma - \rho)$, where σ is the density of the sphere and ρ that of the medium. In the case of a water sphere falling in air, ρ is negligible compared with σ . Hence we have $v = \frac{2}{9} \frac{a^2 g}{c}$.

Accordingly, when the cloud of vapour sinks, we can observe the rate at which the upper surface, which is well defined, falls, and this gives us the value of v .

Maxwell found that the viscosity (c) of air, not very highly rarified, is independent of the density, but proportional to the absolute temperature, and for air at t° the value of c is

$$c = 0.0001878 (1 \times 0.00366 t^\circ).$$

A drop of rain of $\frac{1}{1000}$ th inch in diameter, therefore, falls at the rate of only $\frac{3}{4}$ inch per second in still air. This explains how it is that the white clouds of water particles seen in the sky appear to float in the air. They are in fact falling to earth but very slowly.

If, then, in the Thomson experiment there are n negative ions in each cubic centimetre and each forms the nucleus of a spherical drop of water cloud of radius a , the whole volume

of water per c.c. is $q = n \frac{4}{3} \pi a^3$.

Let ρ_1 be the density of the water vapour after expansion, but before condensation begins, and ρ the density at the final temperature t° , then $\rho_1 - \rho = q$. If L is the latent heat of water vapour, then Lq is the heat given out in this condensation. During the sudden expansion the air will be cooled from $T^\circ C$ to $t_2^\circ C$, but the evolution of the latent heat by condensation raises the air to a temperature, t° . If S is the specific heat of air and M the mass per unit volume, we have

$$Lq = SM (t - t_2).$$

Hence $\rho = \rho_1 - \frac{SM}{L} (t - t_2)$.

In this equation ρ is a known function of the temperature, t , and this is given in hygrometric tables. If T is the

temperature at the beginning of the experiment, and P the pressure of the gas in millimetres of mercury, then since 1 c.c. of air at 0°C and 760 m.m. weighs 0.00129 gram, we have

$$M = \frac{.00129}{x} \cdot \frac{273}{273+T} \cdot \frac{P}{760}$$

where x is the ratio of final to the initial volume of the gas.

Also,
$$\rho_1 = \frac{\rho^1}{x}$$

where ρ^1 is the density of water vapour at $T^{\circ}\text{C}$ before expansion. This can be obtained from the hygrometric tables.

Now, in adiabatic or sudden expansion of air the relation between volume v and pressure p is given by the equation $pv^{1.41} = a \text{ constant}$; whilst for slow expansion we have $pv = R\theta$, where R is the so-called gas constant, and θ is the absolute temperature. Therefore, for adiabatic expansion,

$$v^{0.41} \times \theta = a \text{ constant}$$

or
$$\log_{\epsilon} \frac{\theta_1}{\theta_2} = 0.41 \log \frac{v_1}{v_2}$$

or
$$\log_{\epsilon} \frac{273+T}{273+t_2} = 0.41 \log x.$$

From this equation we can find t_2 , when x and T are given. Then we have :

$$\rho = \frac{\rho^1}{x} - \frac{SM}{L} (t - t_2)$$

and we can substitute the value of t_2 and x from the previous equation. This last equation can be solved by substituting various values for t , and finding the corresponding value of ρ , until we reach values of t and ρ , which agree with the corresponding values in the hygrometric tables.

Having then found ρ and ρ_1 we know q , and also having found a from Stokes formula we find $n = 3q/4\pi a^3$, which gives us the number of drops and therefore of negative ions in the cloud.

By this very ingenious method Thomson weighed the cloud of water spherules and counted the drops of water forming the cloud and therefore determined the number of ions round which the drops were formed. He had then to

determine the whole electric charge contained in this miniature thundercloud. To do this the cloud was formed between a metal plate connected to one terminal of an electrometer, the other terminal being joined to the water surface which supplied the water vapour. If the electrometer is charged to a potential difference V and if the capacity of the whole system is C , then $\frac{Cdv}{dt}$ denotes the rate at which electricity is lost or gained by each terminal.

When so placed between two surfaces at potential difference V and distance apart d the ions are subject to an electric force $E=V/d$, and if A is the area of the plate and u the velocity of the ions per unit potential gradient or electric force, then $neuEA$ is a measure of the electric current represented by the slow migration of all the ions under the action of this electric force E .

Sir E. Rutherford had determined the velocity of a negative ion in air at normal pressure to be 1.5 centimetres per second per potential gradient of 1 volt per centimetre.

Hence in electrostatic units $u=1.5 \times 300=450$.

Accordingly if we determine the loss of electricity per second corresponding to a certain reduction in deflection of the electrometer and so find the value of the decrease expressed as a current in electrostatic units, we have the value of $neuAE$, and hence of e the ionic charge, when all the other quantities are known.

In this way Thomson first found a value for e the electric charge in a hydrogen ion to be $e=6.5 \times 10^{-10}$ electrostatic units. But subsequent measurements by Thomson and others, and especially recent work by Prof. R. A. Millikan, have given a corrected value $e=4.774 \times 10^{-10}$ (E.S.U.).

The above-described experiment repeated with various moisture-saturated gases ionised in various ways, by Röntgen rays or by radium, always gave the above value for the ionic negative charge e , and it will be seen that it is exactly the same as the charge of the hydrogen ion obtained from electrolysis of aqueous solutions.

Hence it is more than probable that we are here concerned in all cases with the same natural unit of electricity—viz., the electron.

We have, however, seen that in the cathode ray tube the ratio of e/m for the cathode ray particle is 5.31×10^{17} , when

THE THERMIONIC VALVE IN

e is reckoned in electrostatic units, and accordingly the mass m of the cathode ray particle must be

$$\frac{4.77 \times 10^{-10}}{5.31 \times 10^{17}} = 9 \times 10^{-28} \text{ gram} = m.$$

But we have seen that there are most probably in 1 c.c. of hydrogen at 0° C. and 760 mm. 2.7×10^{19} molecules or 5.4×10^{19} atoms, and this volume of gas weighs 1/11,200 gram. Hence the weight of an atom of hydrogen is 1.66×10^{-24} gram. Therefore the cathode ray particle has a mass which is 54/100,000, or about $\frac{1}{1850}$ th of that of a hydrogen atom.

This astonishing experimental achievement of Sir J. J. Thomson revealed therefore that in these cathode ray particles or corpuscles we have masses nearly 2,000 times smaller in mass than atoms of hydrogen, up until then supposed to be the smallest masses in Nature.

8. Sir J. J. Thomson then directed his attention to two other cases in which electricity passes through gases, one of which particularly concerns us here.

If an insulated plate of zinc is charged with negative electricity and is illuminated by ultra-violet light the charge rapidly leaks away to an earth-connected grid or grating placed parallel in front of the zinc plate. Electricity must therefore pass through the air from one surface to the other.

Suppose then that we have two metal plates placed parallel to each other and that we bring them to different potentials. There is then an electric force acting in the space normal to the plate surfaces. If a uniform magnetic field of strength H is created with its lines parallel to the plate surface we shall have electric and magnetic forces perpendicular and parallel respectively to the metal surfaces.

Let an ion start from one of the plates which we shall suppose to be the negative plate and move towards the other positively charged plate under the action of the electric force E . Let d be the distance between the plates, and let them be at a difference of potential V ; then $E=V/d$. Let H be the magnetic force parallel to the plates and let e be the ionic charge. Then Ee is the mechanical force on the ion perpendicular to the plates. The ion, however, experiences a deflecting force equal to the product of He and its velocity at that instant and perpendicular to the direction of that velocity.

Suppose that the place from which the ion starts is taken as the origin and that the axis of x is taken perpendicular to the plates and that of y parallel to the plates. Then dx/dt and dy/dt are the axial component velocities of the ion.

The resultant force on the ion along the x -axis is then $Ee - He \frac{dy}{dt}$, and that along the y -axis is $He \frac{dx}{dt}$. Accordingly by the Second Law of Motion we have the equations

$$m \frac{d^2x}{dt^2} = Ee - He \frac{dy}{dt}$$

$$m \frac{d^2y}{dt^2} = He \frac{dx}{dt}$$

or using the Newtonian notation in which a dot over a letter signifies differentiation with regard to time, and two dots double differentiation, we have the equations,

$$\ddot{x} = E \frac{e}{m} - H \frac{e}{m} \dot{y}$$

$$\ddot{y} = H \frac{e}{m} \dot{x}$$

These equations show that the path of the ion is a cycloid.

A cycloid is the curve described by a point on the circumference of a circle which rolls on a straight line.

Let OPQ be a circle (see Fig. 21) rolling on a straight line OA . Let P be any point on the circle, and let the radius of the circle $OC = r$. Let x and y be the co-ordinates of P , and A the origin or contact place from which the circle starts to roll.

Then let $AN = y$ and $NP = x$, and let the angle through which the circle has turned $= OCP$ be denoted by pt , where p is angular velocity, and $t =$ time of rolling. It is then obvious that

$$x = r - r \cos pt$$

$$y = rpt - r \sin pt$$

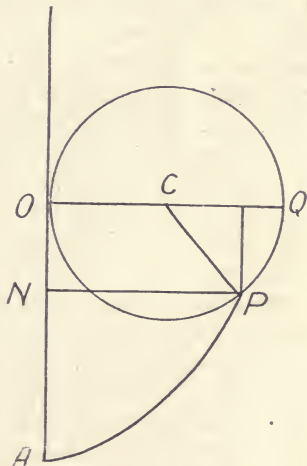

FIG. 21. — Generation of a Cycloid.

THE THERMIONIC VALVE IN

Differentiate these equations twice with regard to t , and we obtain

$$\ddot{x}=rp^2 - p\dot{y}, \quad \ddot{y}=p\dot{x}.$$

If we compare these two last equations with the above equations of motion of the ion, we see at once they are identical provided we put $p=H \frac{e}{m}$ and $r=\frac{E}{H^2} \frac{m}{e}$. This proves that the path of the ion must be a cycloid.

Hence, if the ion starts from one plate under the action of the two forces due to the electric and magnetic force, it will curl round in a cycloidal path. If, then, the distance between the two plates exceeds twice the radius of the circle, or $\frac{2 E m}{H^2 e}$, the particle will never reach the second plate.

Thomson applied the above theorem to the case of the ions emitted by an incandescent carbon filament. He stretched a filament close in front of a metal plate, and placed at a certain distance, d , from it a second parallel metal plate. These plates and filaments were included in a glass vessel very highly exhausted. The filament was connected to the plate just in contact with it, and a difference of potential, V , made between the plates.

Hence the electric force $E=V/d$. Coils of wire were placed outside the tube, and through them a current was sent, so as to make a magnetic force, H , of known and adjustable value parallel to the plates. When the carbon filament was made incandescent it emits, as we have seen, negative ions, and by adjusting the magnetic field it was possible just to prevent these ions reaching the second plate. From measurements of H , V , and d it was then possible to solve the equation $d=\frac{2 E m}{H^2 e}$, so as to obtain the value of e/m .

Thomson's experiments made by the above method in 1899 led to a value of e/m for the negative ions emitted by an incandescent carbon filament which was not very different from that obtained from experiments on the cathode ray corpuscle, but in absolute value were too low. More recent measurements by Professor O. W. Richardson gave values $e/m=1.45 \times 10^7$ and 1.49×10^7 , and more recent work still by Bestelmeyer, who used an improved method, has given the

value $e/m=1.766 \times 10^7$ in E.M. units, and this is very close indeed to the best results for the cathode ray corpuscle, which, as we have seen, gives $e/m=1.77 \times 10^7$ in E.M. units. For full details of the latest and best work on this matter we may refer the reader to the book by Professor O. W. Richardson, *The Emission of Electricity from Hot Bodies* (Longmans, Green & Co.), in which the theoretical and physical side of the subject is most fully treated.

Summing up the results of twenty years' physical discovery on this subject, we may say that an exceedingly strong body of proof has been built up supporting the following statements :

1. The agency we call Negative or Resinous Electricity is atomic in structure, and the atom or smallest indivisible unit of it is called an electron ($=e$). The electron charge is equal to 4.774×10^{-10} of an electrostatic unit of quantity of electricity, or to 1.591×10^{-20} of an electromagnetic unit, or to 15.91×10^{-20} of a coulomb. It is the quantity of electricity conveyed by a hydrogen ion or atom of hydrogen in electrolysis, and is Nature's unit of electricity. A current of 1 ampere flowing for one second is equivalent to the passage of six million million million electrons across any section of the circuit.

2. This electron has a certain mass ($=m$) which is approximately $1/1,800$ of that of a hydrogen atom, and is close to 9×10^{-28} of a gram.

The question has been much discussed whether the electron is anything else but a point-charge of electricity, and whether its mass is due to anything but the electrical properties of a moving charge of electricity.

7. If we consider a small sphere charged with electricity to be at rest, it exerts radial electric force which at a point at distance r from its centre is e/r^2 , where e is the electric charge. When the sphere is at rest the lines of electric force are everywhere radial to the sphere. If the sphere is set in uniform motion with a velocity, v , then the moving charge is equivalent to an electric current, and it creates in surrounding space a magnetic force distributed in circles whose centres lie on the line of motion and planes are perpendicular to it. At a point at distance r , the radius vector making an angle θ with the line of motion, the

magnetic force, H , due to the moving charge, has the value

$$H = \left(1 - \frac{v^2}{c^2}\right) \frac{ev \sin \theta}{r^2 \left(1 - \frac{v^2}{c^2} \sin^2 \theta\right)^{\frac{3}{2}}}$$

where $c = 3 \times 10^{10}$ cms. per second, and e is the charge of the sphere. The proof of this formula is difficult, but has been given by Sir J. J. Thomson in his book *Recent Researches in Electricity and Magnetism*, p. 19, and also by Mr. Oliver Heaviside in his *Electrical Papers*.¹ It has been somewhat simplified by the author for his own University lectures.

If the velocity of the sphere is small compared with that of light ($=c$), then the above formula reduces to the formula of Ampère: $H = \frac{ev \sin \theta}{r^2}$ for the magnetic force of a current element, ev , at a point r , θ . If the sphere moves quickly, then the lines of electric force do not remain uniformly distributed round the sphere, but crowd up towards the equatorial plane, assuming that the direction of motion is that of the polar axis.

The sphere creates a magnetic field whilst it moves, and a magnetic field of strength, H , implies that there is energy equal to $H^2/8\pi$ per unit of volume in that field.

If we consider the velocity of the sphere is small, so that v^2/c^2 can be neglected in comparison with unity, then

$$\frac{H^2}{8\pi} = \frac{e^2 v^2 \sin^2 \theta}{8\pi r^4}$$

To obtain the energy of the whole magnetic field, we have to integrate this expression throughout all space external to the sphere, which latter we shall suppose has a radius a . Calling this energy T , we have

$$\begin{aligned} T &= \frac{e^2 v^2}{8\pi} \int_a^\infty \int_0^\pi \frac{\sin^2 \theta}{r^4} 2\pi r^2 \sin \theta \, dr \, d\theta \\ &= \frac{e^2 v^2}{4a} \int_0^\pi \sin^3 \theta \, d\theta = \frac{e^2 v^2}{3a} \end{aligned}$$

¹ See J. J. Thomson, *Phil. Mag.*, 5th Series, vol. xi., p. 229, 1881; also Oliver Heaviside, *Phil. Mag.*, 5th Series, vol. xxvii., p. 324, 1889.

Accordingly, the whole kinetic energy of the sphere is

$$\frac{1}{2} mv^2 + \frac{e^2 v^2}{3a} = \left(m + \frac{2}{3} \frac{e^2}{a} \right) v^2$$

The mass of the electrified moving sphere may therefore be regarded as increased by an amount $2e^2/3a$, due to its electrification. In the case of the electron the question which arises is, whether there is any other mass than that due to the magnetic field?

Kaufmann measured, in 1901, the ratio of e/m for certain cathode ray corpuscles moving with high velocity and, later on, of others emitted by radium and has found that this ratio, e/m , is reduced in value as the velocity of the particle is increased; and from this Sir J. J. Thomson and others conclude that the mass of the moving electron may perhaps be wholly due to the energy stored up in its magnetic field. If this is a fact, and if we assume a spherical form for the corpuscle, we can find its radius, a , for we have found the mass, m , of the corpuscle to be 9×10^{-28} gram, and its charge, e , to be 1.59×10^{-20} E.M. units. Therefore,

$$\frac{9}{10^{28}} = \frac{2}{3} \frac{e^2}{a} \text{ or } a = \frac{2}{27} \frac{(1.59)^2}{10^{12}} = 1.85 \times 10^{-13}$$

Hence the radius of an electron is of the order of one ten-billionth of a centimetre. The radius of an atom of matter is of the order of one hundred-millionth of a centimetre, and therefore the electron has a diameter of about one hundred-thousandth of that of a chemical atom.

The dome of St. Paul's cathedral is about 110 feet in diameter, and that of St. Peter's at Rome about 170 feet.

The diameter of an ordinary small pin's head is about $\frac{1}{16}$ th of an inch. If we imagine a great balloon having a diameter five times that of the dome of St. Paul's, or three times that of St. Peter's, then such a sphere would be as much larger than an ordinary pin's head as an atom of hydrogen is possibly larger than an electron.

These conclusions as to the volume of an electron are not, however, established with the same degree of certainty as is the case with its mass. Mr. A. H. Compton (see *Journal, Washington Academy of Science*, vol. viii., p. 1, Jan. 3rd, 1918; also *Science Abstracts*, vol. xxi.a, May, 1918, abs. 549) has given reasons for thinking that the electron cannot be a charged sphere of so small a diameter as 10^{-13} , but

may be a charged ring of a radius of about 2×10^{-10} cms. capable of rotating about any axis. If this is so, we may come back to some kind of Vortex-ring theory of electron structure as originally propounded by Lord Kelvin for the chemical atom.

8. Then, as regards positive electricity, there is evidence that this also is atomic in structure. The ratio e/m has been measured for positively charged corpuscles in a high vacuum tube, and it is found to be of the order of e/m for a hydrogen ion in electrolysis—viz., about 10^4 . Hence positive electricity is associated with masses of the size of atomic masses.

The generally-held view at present is that an atom is a sort of solar system in miniature. The nucleus of the atom is a charge of positive electricity concentrated in a very small space, which may consist of one or more positive electrons.

The gravitative mass of the atom is chiefly due to this positive nucleus. Around this nucleus circulate a group of negative electrons like planets round the sun. If the number of negative electrons is sufficient to equilibrate the positive charge, then the atom is in a neutral electrical condition.

If the neutral atom is deprived of one or more negative electrons it is positively charged and constitutes a positive ion. If the neutral atom gains or takes up one or more negative electrons it becomes negatively charged and forms a negative ion. Chemical atoms have certain loosely-held or detachable electrons, which are called the valency electrons, and the view is very widely held that chemical attractions and combinations are due to electric forces acting between atoms, or groups of atoms, which have respectively gained or lost electrons.

In a solid metallic conductor, or conductor such as carbon, it is supposed that there is a continual exchange of negative electrons between neighbouring atoms. Electrons are, so to speak, jumping from atom to atom, and during their time of passage they constitute what are called the "free" electrons.

These motions take place in all directions, and the temperature of the body is determined by the kinetic energy of these free electrons. If an electromotive force

acts on the conductor it applies a definite electric force to these free electrons, and over and above their indiscriminate motions a certain steady drift of electrons in one direction then takes place, which constitutes an electric current. These free electrons may be regarded as the molecules of a kind of gas existing in between the chemical atoms of the conductor. It has been, therefore, assumed that they obey the ordinary gas laws. The free electrons have a certain "mean free path" and a certain "mean square velocity," like gas molecules.

They do not at ordinary temperatures escape from the conductor because if any did, it would leave the conductor positively electrified, and this would tend to prevent the escape of more electrons.

But if the temperature of the conductor is raised the electrons may acquire such velocities that some are flung out beyond the attractive range of the positive ions left behind. This escape of the free electrons rises very rapidly with temperature, and constitutes what is now called the *thermionic current* from the incandescent wire. This current is measured by the quantity of electricity escaping per square centimetre per second from the surface of the incandescent wire or body.

9. The study of the nature, variations and magnitude of this thermionic emission has been the subject of much investigation from a purely physical point of view.

As the chief purpose of the present volume is to direct attention to the technical applications of this phenomenon, we shall not occupy space with descriptions or discussions of the physical problems more than is necessary to explain the general principles involved. The experimental examination of the effect has been chiefly conducted by means of a simple apparatus, consisting of a straight metallic wire or carbon filament which is attached to platinum electrodes and sealed into a glass cylindrical bulb in an axial position.

Surrounding the filament is a tubular electrode made of metal, generally platinum, and this cylinder has a metallic connection made to it by a platinum wire welded to the cylinder and sealed through the glass (see Fig. 22).

The glass vessel can be exhausted to various pressures through a side tube or filled with various gases. If the surrounding metal cylinder is not employed, and if the wire

THE THERMIONIC VALVE IN

or filament is heated by an electric current passed through it, then the ions or electrons given off by the wire would accumulate to a certain extent in the space, vacuous or gas-filled, round the wire and create a *space electric charge* which would soon prevent any further emission. This explanation of the limitation to the increase of the thermionic emission was first given by Mr. C. D. Child in 1911 (see *Physical Review*, vol. xxxii., p. 498, 1911).

By employing the metal cylinder we can make a definite difference of potential between the heated wire and the cold cylinder, and, therefore, an electric force so directed as to urge the ions from the wire to the embracing cylinder. The arrangement has also the convenience that we can determine the temperature of the incandescent wire by measuring its resistance or ratio of volt-drop down the

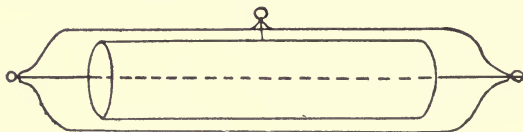

FIG. 22.—Exhausted tube having in it a metal cylinder and concentric incandescent tungsten wire to show the thermionic emission from the wire.

filament to current through it, or else by making the filament one arm of a Wheatstone's Bridge arrangement.

If we have previously determined the resistance of the filament at several standard temperatures we can by interpolation or extrapolation determine its temperature corresponding to other resistances.

Such an apparatus is a convenient modification of the lamps used by the author or by Sir William Preece in examining the Edison effect.

As soon as experiments began to be made with the above apparatus it was found that the observed effects were complicated and depended upon a great many factors, such as (1) the material of the wire or filament heated, (2) its temperature, (3) the gases or impurities occluded in it, (4) the nature of the gas surrounding it, (5) the pressure of this gas, and (6) the previous treatment of this wire as regards heating and exhaustion.

Broadly speaking, we may say that when the pressure of

the gas in the bulb is not extremely small—that is, when the vacuum is not extremely high—the effects will be complicated by the ionisation of this gas by the electrons emitted by the wire or filament, and this will give rise to positive and negative ions in the surrounding gas.

It soon became clear that to simplify the phenomena the removal of all gas round the heated wire and all gas films from the interior surfaces in the vessel and occluded gases from the materials was essential. This can only be done by prolonged heating of the whole apparatus and most careful exhaustion.

For this purpose very perfect mechanical vacuum pumps, such as the Gaede pump, must be employed and the exhaustion completed by the use of chemical means or by Sir James Dewar's method of absorption of residual gases by charcoal, particularly cocoanut charcoal fragments, cooled in liquid air (see chap. ii., sect. 9).

It is also necessary to heat the experimental vessel in an electric furnace, or by other means, during the exhaustion, and to prevent the collapse of the glass tube this may have to be done in a vacuum electric resistance furnace. The greatest difficulty is to eliminate occluded air or gas from the metal collecting cylinder.

As these precautions are equally necessary in the construction of thermionic detectors used in radiotelegraphy a few more details may be given. It is an extremely difficult matter to heat a metal collecting plate which is sealed up inside an exhausted glass vessel sufficiently to expel occluded gas by mere external heating. It is easier to do it if the collecting plate is formed of a wire coiled into a close spiral with turns nearly in contact, because then both ends of this wire can be welded to platinum wires which are sealed through the glass, and we have then access to the terminals of the spiral wire and can heat it intensely by an electric current passed through it.

We can then aid the exhaustion by the method of Sir James Dewar, connecting the glass vessel to a glass bulb filled with crushed fragments of cocoanut charcoal (see chap. ii., sect. 9). This bulb has to be hermetically sealed to the thermionic vessel. When the vacuum has been made as high as possible by the pump the charcoal bulb can be immersed in liquid air and will absorb the residual gas. By

long-continued heating and pumping it is possible to reach a state in which the pressure of the residual air does not exceed 10^{-6} , or even 10^{-8} , of a millimetre of mercury. As the diffusion of the rarefied air along connecting tubes is slow the exhaustion and simultaneous heating of the bulb to about 60° C. may have to be continued for several days. At the same time an electric current must be passed through the wire or filament of carbon to heat it and to expel from it all absorbed gases or volatile material.

Tungsten forms a very suitable material for the incandescent wire. This metal has a very high melting point (3270° C.), vastly higher than that of platinum (1755° C.) and higher than the temperature at which carbon begins to volatilise rapidly. Tungsten is very non-volatile and can be heated for long periods to a very high temperature without change. It is possible therefore to obtain from it very large thermionic emission, as much as a coulomb or more per second per square centimetre of surface. A thermionic current of the above strength implies the emission of 6×10^{18} electrons per square cm. per second. We shall presently discuss the origin of these electrons.

If in such an apparatus as above described we pass a current through the wire and heat it to a known absolute temperature T , and if we apply a battery of known voltage to send a negative current from the hot filament to the cold cylinder and measure the thermionic current we can plot out in the form of a curve the relation between thermionic current and potential difference (P.D.) between the filament and cylinder. If the vacuum is very high so that secondary ionisation effects are avoided we find that the curve so delineated resembles in form the magnetisation curve of iron. The thermionic current increases at first slowly, then more quickly, but finally attains a nearly constant value, which is not exceeded provided no secondary ionisation takes place (see Fig. 23).

When this point is reached the current is said to be *saturated*, and it has been found that this saturation current has a definite relation to the absolute temperature T of the hot body.

Proceeding on certain physical hypotheses, Professor O. W. Richardson¹ has deduced the following formula for

¹ See *Phil. Trans. Roy. Soc. Lond.*, vol. cci., p. 516, 1903.

the saturation current I per square cm. in terms of T and certain constants C and b : $I=C\sqrt{T} \epsilon^{-b/T}$, where ϵ is the base of the Napierian logarithms. We can also reckon I in its equivalent in number of electrons per second per square centimetre N , and write $N=A\sqrt{T} \epsilon^{-b/T}$.

By multiplying N by the electronic charge $e=4.8 \times 10^{-10}$ and then dividing by 3×10^{-6} we reduce to milliamperes per square centimetre of surface ($=i$).

The value of the constants A and b have been determined for various materials.

For a *platinum* wire Richardson found $A=7.5 \times 10^{25}$, $b=4.93 \times 10^4$; for a *carbon* filament he found $A=10^{34}$, $b=7.8 \times 10^4$; whilst for a *tungsten* wire Langmuir has

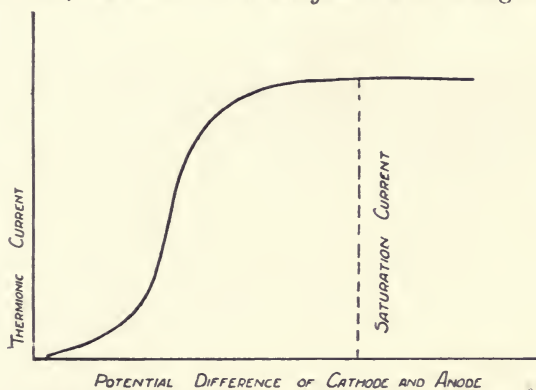

FIG. 23.—Characteristic or Volt-ampere Curve of a highly rarefied gas or nearly perfect vacuum space.

found $A=1.55 \times 10^{26}$, $b=5.25 \times 10^4$; and for *tantalum* $A=7.45 \times 10^{25}$, $b=5 \times 10^4$.

The constant b seems in all cases to be of the order of 50,000, but A is very variable.

Either of the above formulæ for I or N gives results in very fair agreement with observation.

It will be seen that the electronic emission from the heated wire rises up very rapidly with increase of temperature, and hence the advantage in technical applications of employing a material like tungsten which can be heated without alteration to a high temperature.

Sir J. J. Thomson has shown (see *Conduction of Electricity Through Gases*, p. 166) that from the known values of the

THE THERMIONIC VALVE IN

constants A and b in the Richardson formula we can determine the number of free corpuscles or electrons (N) per unit volume of the metal or material used for the heated filament, and also the work (w) required to drag or force an electron out of the metal. Thus from experiments on a platinum wire by Richardson which gave $A=1.5 \times 10^{26}$, $b=4.93 \times 10^4$, Thomson deduces $N=1.3 \times 10^{21}$ and $w=8 \times 10^{-12}$ erg.

Broadly speaking, it appears that the number of free electrons in a conductor in any volume is of the order of the number of atoms in the same space.

10. A matter which has been very much discussed is the origin of these negative ions or electrons emitted by a highly-heated metallic wire or carbon filament.

It was found by H. A. Wilson that the thermionic emission from an incandescent platinum wire was greatly increased by admitting hydrogen gas into the vessel, and similar effects have been noticed for heated palladium and sodium. Langmuir, however, found a great reduction in the emission from tungsten when hydrogen was present in the vessel, which he ascribed to secondary chemical actions. Some observers have attributed the thermionic emission from carbon to the action of gases occluded in the material, and stated that when the carbon is freed from these gases the thermionic emission is greatly reduced.¹ O. W. Richardson has, however, criticised these conclusions and shown that the reduction of electronic current in the case of the experiments of Pring and Parker can be accounted for by the deflection of the electrons due to the magnetic field of the current itself, causing incandescence in the carbon conductor (see Richardson, *The Emission of Electricity from Hot Bodies*, pp. 65 and 130). Richardson concludes from very careful experiments that there is no certain proof that the thermionic emission from metals or carbon is the direct result of chemical action, but that it is a thermal phenomenon when carried out with pure materials in a high vacuum. Nevertheless, the emission is enormously affected by the presence in or around the incandescent wire of other substances.

Thus, A. Wehnelt in 1903 and 1904 investigated the

¹ See J. N. Pring, "The Origin of Thermal Ionisation from Carbon," *Proc. Roy. Soc. Lond.*, vol. lxxxixA, p. 344, 1913; see also Pring and Parker, *Phil. Mag.*, vol. xxiii., p. 199, 1912.

thermionic emission from platinum wires coated with oxides of calcium, barium or strontium, and found that in vacuo such oxide-coated wires emit far more corpuscles or electrons per sq. cm. per second than a pure platinum wire at the same temperature (see *Phil. Mag.*, vol. x., p. 80, 1905). He found that otherwise the thermionic saturation current from these oxide-covered wires was related to the absolute temperature in accordance with Richardson's exponential formula already given. There is a very copious emission of negative ions from the glower of a Nernst lamp, which glower consists of oxides of rare earths. This has been investigated by G. Owen.¹

It is easy to show this effect with a Nernst glower heated by a direct current. If a Nernst glower is supported with the bare glower in a horizontal position placed within a few millimetres of the bottom of a metallic insulated vessel kept cold by being full of water, and if one terminal of a galvanometer is connected to the positive terminal of the glower and the other to the cold vessel, a considerable thermionic current will be found passing through the air even at ordinary pressures.

It has been stated that Langmuir found heating a filament containing thorium in the neighbourhood of a tungsten wire increases the thermionic emission of the latter a million-fold (see *Nature*, vol. xcviii., p. 146, Oct. 26th, 1916).

Apart from the effect of such admixtures or surface coatings on the thermionic current from a wire, we have to note the effect of the surrounding rarefied gas upon it when the difference of potential between the incandescent filament and the collecting plate is made sufficiently great. In that case the ions or electrons projected from the filament ionise the gas molecules, and the negative ions so produced are carried by the electric force up to the collecting plate and will then increase the apparent thermionic current. This is generally represented by that stage in the curve connecting P.D. between hot wire and plate and the thermionic current at which the curve begins to rise very quickly. The curve in Fig. 24 shows the results of some experiments by McClelland in 1902 on the emission of positive electricity from a wire which exhibits a third

¹ See G. Owen, *Phil. Mag.*, vol. viii., p. 230, 1904, "On the Discharge of Electricity from a Nernst Filament."

THE THERMIONIC VALVE IN

stage in the characteristic curve when the thermionic current begins to increase again after one saturation stage has been reached.¹ This appears so be due to the production of fresh ions from the surrounding gas. The result of exhaustive experiments has, however, shown that in the highest possible vacua, when using carefully prepared and long-heated tungsten wires as heated filaments, the thermionic emission is entirely due to electrons coming from the metal, and at a sufficiently high temperature may reach even 3 or 4 amperes per square centimetre of surface of the incandescent wire.

A question, then, which has peculiar interest, is the source of these emitted electrons. O. W. Richardson has conducted and described special experiments, made with the object of obtaining an answer.² A very carefully

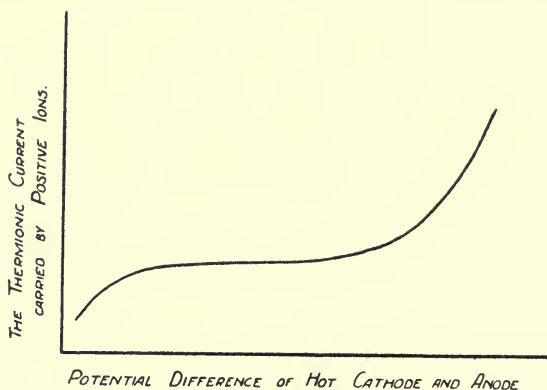

FIG. 24.—Characteristic curve for vacuous space not very highly exhausted. The final rise in the curve is due to gas ionisation by the applied voltage.

prepared tungsten filament was used, heated in a high vacuum, in which the pressure was less than 10^{-7} of a millimetre of mercury. The filament gave out an electronic current of 0.5 ampere for 30 minutes or 1,800 seconds, equivalent to 900 coulombs. This implies the total emission

¹ See J. J. Thomson, *Conduction of Electricity through Gases*, 1st Edition, p. 186.

² See O. W. Richardson "On the Emission of Electrons from Tungsten at High Temperatures," *Phil. Mag.*, vol. xxvi., p. 345, 1913 also his book, *The Emission of Electricity from Hot Bodies*, p. 133.

of 54×10^{20} electrons or 3×10^{18} electrons per second. Richardson carefully discusses in this paper, in the light of numerical values, the possibility of these electrons having come from the atoms of the tungsten evaporated, or from the ionisation of the residual gas, and shows that both these suppositions are inadmissible. In one experiment 984,000 electrons were emitted per atom of tungsten evaporated. He came to the conclusion that these electrons could only have come into the tungsten from other portions of the electric circuit, of which it formed part; in other words, that the electrons emitted are the "free" or conductivity electrons of the metal.

11. The subject of the emission of positive ions from incandescent wires has no such great practical interest at present as that of the emission of negative corpuscles or electrons, but reference must briefly be made to it.

We have seen that when a platinum wire is heated to a red heat in vacuo it gives off, at first, positive electricity, and this is quite distinct from any subsequent production of positive ions in the surrounding gas. This positive emission is, however, a short-lived effect. It does not remain constant, but rapidly decays away with time. A wire which has lost the power of positive emission will regain this power if heated in air or in a Bunsen flame. It is clear from measurements made of the ratio, e/m , for these positive ions that they are masses of atomic magnitude and appear to owe their origin to gases occluded in the heated wire or resulting from interaction between the atoms of the heated wire and the surrounding gas. The reader desiring to make a further study of this portion of the subject will find a valuable collection of experimental results in Professor O. W. Richardson's book, and in latest editions of Sir J. J. Thomson's book on *Conduction of Electricity through Gases*, and in his smaller book, *The Corpuscular Theory of Matter* (Constable & Co.).

A very readable account of the electron theory of electricity is given in Mr. G. W. de Tunzelmann's book, *A Treatise on Electrical Theory* (C. Griffin & Co.). In Thomson's book on *The Corpuscular Theory of Matter* will be found a particularly full discussion of the electron theory of electric and thermal conduction.

CHAPTER II.

THE FLEMING OSCILLATION VALVE.

1. From the brief sketch of thermionic phenomena which has been given in the previous chapter it will be seen that the emission of electricity from incandescent filaments of carbon or metal had attracted the close attention of many eminent physicists in Europe and the United States during a period of about twenty years between 1884 and 1904.

It is nevertheless remarkable that with the exception of one small application made of the "Edison effect" by Mr. Edison himself, disclosed in a United States Patent Specification, No. 307,031, filed November 15th, 1883, and patented as from October 21st, 1884, in which he proposed to employ it as a means of notifying any change in potential difference of the mains of an electric light supply system, no technical use or practical application of these thermionic effects was made by anyone until the subject was taken up again in 1904 by the author of this book. The writer was the first to apply the thermionic emission from an incandescent filament of metal or carbon contained in an exhausted glass vessel having in it a metal collecting plate carried on a wire sealed through the glass, for the technical purpose of rectifying high frequency alternating currents and so detecting the feeble electric oscillations in a wireless telegraph receiving circuit by some form of galvanometer, or by a telephone, and thus making a new and sensitive form of radio-detector, since known as the Fleming Valve.

For the purposes of litigation or in depreciation of the author's work it has been contended by more recent utilisers of these effects in electrotechnical fields that no inventive power was required to make this application of an already known appliance—viz., an electric glow lamp having a metal plate sealed into the bulb. The question of novelty in

application is one that frequently comes up in connection with patent litigation.

In this case it so happens that the author is not dependent upon himself or any private person for an opinion on this point. It has been given with authority by the unanimous judgment of three Judges in the United States Circuit Court of Appeals for the Second Circuit on May 9th, 1917, in an appeal from a judgment of His Honour Judge Mayer in an action brought by the Marconi Wireless Telegraph Company of America against the De Forest Radio Telephone and Telegraph Company of the United States for infringement of the author's United States Valve Patent No. 803,684 of 1905. In that action, to which additional reference is made in the next chapter, one argument of the defendants was that no invention was required to apply the Edison lamp with metal plate in the bulb as a rectifier of oscillations or receiver in wireless telegraphy, and that anyone was at liberty to use this appliance in radiotelegraphy.

Edison had applied for in 1883 and obtained the above-mentioned United States patent for employing an incandescent lamp with a metal plate sealed into the bulb as a potential regulator for an electric light circuit, but had disclosed no application of the same with reference to the rectification of alternating currents or as a detector for electric oscillations.

Extracts from this important Court of Appeals judgment having reference particularly to the question of invention in this fresh application of a known appliance are as follows. The Court said :—

“ The Fleming Valve as a detector confessedly, and the actual commercial audion (as we are convinced) consist essentially in the utilisation by visible and tangible means of what has long been known as the ‘ Edison effect.’ . . .

“ Utilisation of the Edison effect does not mean that the use of Edison's apparatus or any modification thereof as a detector was easy or simple. The admitted fact that years passed and detectors of various kinds, from the coherer to the crystal, acquired vogue before anyone thought of using Edison's curiosity of electricity for the discovery or translation of Hertzian waves is proof enough on this point. . . .

“ Fleming was the first to disclose an apparatus for this purpose. . . .

THE THERMIONIC VALVE IN

“ Was it invention to use as a detector of wireless waves an Edison hot and cold electrode lamp ?

“ This is a question of fact, and we arrive at the conclusion of the Lower Court, that at the date of Fleming's application it was not known to men skilled in the radio art that a rectifier would act as a detector or that anything that would rectify oscillations of a low frequency could rectify waves of the order used in radio communication. . . .

“ Edison's patent stated a fact and suggested a tantalising mystery, because even he did not pretend to state or assert that he knew why his ' effect ' took place.

“ His disclosures remained (as far as we can discover from the record) a laboratory problem until Fleming applied it to a new and very practical field of usefulness. . . .

“ We have no doubt that Fleming's patent displays invention and of a very meritorious device. . . .”

Having therefore this pronouncement from a legal tribunal of the highest kind, after exhaustive examination of the facts, the story of the initial invention in connection with thermionic detectors may be resumed. As soon as Senatore Marconi had perfected and brought into use his admirable magnetic detector its many advantages caused the use of the coherer as a detector to begin to decline. Nevertheless, the magnetic detector had the disadvantage that the signals being audible only and received by telephone the telegraphist had no record of them as in the case of the coherers employed with relay and Morse inker. Also the strain on the attention of the observer was greater, because if a code message was being received, the omission of a single *dot* or *dash* might make nonsense of a word.

Hence the author was desirous, if possible, of finding some method of working a sensitive relay by means of the feeble damped oscillations or intermittent telephone currents. Furthermore, having become the subject of a progressive deafness the writer desired to find some instrument to record radiotelegraphic signals which would appeal to the eye and not to the ear.

It was well known in 1904 that no instrument then in use for the detection of alternating currents was nearly as sensitive as the mirror galvanometer of Lord Kelvin, used in submarine cable work, is for direct or unidirectional currents. All such instruments as hot wire or thermo-

electric ammeters and electrodynometers are vastly less sensitive to alternating currents, no matter how they are constructed, than is a good mirror, moving coil or needle galvanometer, to direct currents. The latter type of instrument can easily be made to give a sensible deflection for one-hundredth of a microampere, whereas none of the best alternating current galvanometers which are quick acting enough to use as telegraphic receivers would operate with as small a current as a tenth or hundredth of a milli-ampere.

Accordingly, one problem the author set to himself was to find a method of utilising a mirror galvanometer such as is, or was, employed in submarine cable signalling to detect the signals in wireless telegraph work.

It must be remembered that at that date none of the crystal or rectifying detectors or contacts had been invented. These did not make their appearance until about 1906.

It was obvious that to solve the problem some method must be found of converting high frequency alternating currents into direct or unidirectional currents. Hence the oscillations must be rectified by some form of valve.

Electricians were at that time familiar with the aluminium-carbon electrolytic cell as a means of rectifying low-frequency alternating currents.

If plates of clean aluminium and graphitic carbon are immersed in an aqueous solution of sodic phosphate, or even dilute sulphuric acid, if a current is passed through this electrolytic cell, from carbon to aluminium, the current will liberate hydrogen against the aluminium, and will continue to flow. If, however, the direction of the current is reversed and oxygen or hydroxyl ions are deposited on the aluminium, they speedily form an impervious film of aluminic hydroxide, which stops the current.

If, therefore, an alternating electromotive force is employed current will pass through the cell in one direction, but not in the opposite, and the cell will act as a valve or rectifier for alternating currents. An arrangement of four aluminium cells of the above kind constitutes the well-known Nodon valve rectifier.

When an attempt was made to employ such an arrangement for the rectification of high-frequency oscillations it was found that it did not operate. It appears that the

THE THERMIONIC VALVE IN

chemical actions on which the unilateral conductivity depends take time, and are not effected when the frequency of the current is very high. After trying a number of these electrolytic rectifiers, without success, the author recalled to mind his experiments of 1889 and 1890 on the "Edison effect," and thought it would be desirable to try by experiment whether the known unilateral conductivity of the vacuous space for direct currents would also exist for high frequency alternating currents. Accordingly, some of the lamps with middle plates, grids and tubes employed in his former experiments were taken out of the cabinet where they had stood, unused, for several years, and employed as follows: An oscillation circuit was set up,

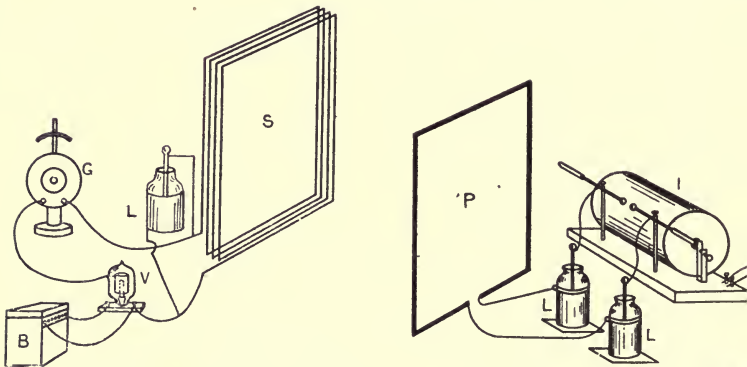

FIG. 25.—ARRANGEMENTS FOR EXHIBITING THE RECTIFYING POWER OF AN OSCILLATION VACUUM VALVE.

I, Induction Coil. L, L, Leyden Jars. P, Primary Oscillation Circuit.
S, Secondary Circuit. G, Mirror Galvanometer. V, Fleming
Oscillation Valve. B, Valve Battery.

consisting of a square wooden frame, on which about a dozen turns of insulated wire was wound. This circuit was joined in series with a pair of Leyden jars, or condenser, and with a pair of spark balls and the balls connected also to the secondary terminals of an induction coil. Hence, when the coil was set in action electric oscillations were created in the circuit at every discharge spark (see Fig. 25).

At a certain distance from this circuit another oscillation circuit was set up, consisting of a similar coil of wire on a square frame and a condenser in series with it. This

circuit was tuned to the same frequency as the primary circuit. The filament of an incandescent lamp, having a metal plate in its bulb carried on an insulated terminal, was then connected to a battery, so as to incandesce the filament; and the insulated plate in the lamp was connected to one terminal of the condenser in the secondary circuit. The negative terminal of the lamp battery was then connected through a mirror galvanometer with the other terminal of the condenser (see Fig. 25).

On setting up the oscillations in the primary circuit the mirror galvanometer gave a large and steady deflection, showing that a unidirectional current was passing through it. Even when the condenser in the secondary circuit was removed, and that circuit thus made aperiodic with the galvanometer and lamp in series with it, there was a steady deflection of the needle. This confirmed the

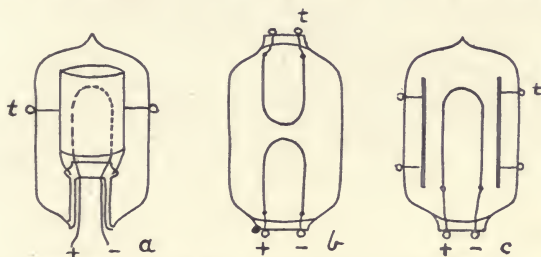

FIG. 26.—Various forms of Fleming Oscillation Valve made in 1904.

author's anticipations, and showed that such a lamp with plate in the bulb could be made to act as an "oscillation valve" or rectifier of high-frequency electric oscillations to make them detectable by an ordinary mirror galvanometer.

It was then at once evident that the combination of valve and galvanometer could be used to detect the oscillations, and therefore read the signals in a wireless telegraph receiver. All that had to be done was to connect the valve with galvanometer in series as above shown across the terminals of the condenser in the secondary circuit of the receiver.

The author, therefore, had made as soon as possible some new lamps by the Edison and Swan United Electric Light Company, in which the filament was a treated carbon filament, made with the usual squirted soluble cellulose, of

THE THERMIONIC VALVE IN

such size as to be rendered fully incandescent by a P.D. of 12 volts applied to the filament terminals. Surrounding the filament, but not touching it, was placed a sheet-metal cylinder fixed to a platinum wire sealed through the glass (see Fig. 26a).

The lamp was fixed on a convenient wooden stand provided with terminals for the ends of the filament and for the metal cylinder (Fig. 27). The exhaustion of the bulb was

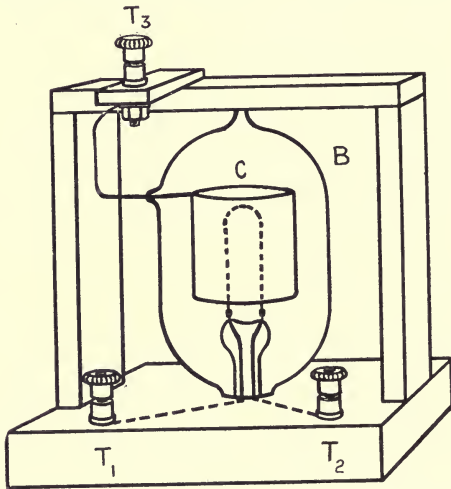

FIG. 27.—FLEMING OSCILLATION VALVE, B, MOUNTED ON WOODEN STAND.

T_1 T_2 , Terminals of valve filament or hot cathode.
 T_3 , terminal of cylinder or cold anode, C.

pushed as far as possible and, at the same time, the filament heated electrically, and the bulb and cylinder heated by a gas oven, so as to expel as far as possible all occluded air. Fig. 28 shows a photograph of the original glow-lamp valves, which the author first used for this purpose, henceforth called an "oscillation valve."

Patent protection was applied for covering the use of such a valve as a rectifier of oscillations and as a detector or receiver in wireless telegraphy in a number of the principal States of the world.¹ Fig. 28a shows photographs of various forms of

¹ In Great Britain, No. 24,850, of November 16th, 1904; in the United States, No. 803,684, April 19th, 1905; in Germany, No. 186,084, Klasse 21a, Gruppe 68, April 12th, 1905. Granted to John Ambrose Fleming or to his assignees Marconi's Wireless Telegraph Company Limited, of London, or of America. By a disclaimer filed in the United States Patent Office, November 17th, 1915, Marconi's Wireless Telegraph Company of America disclaimed the combinations of claims 1 to 6 inclusive and 10 to 15 inclusive in Patent No. 803,684, except as the same are used in the radio art.

The same invention was patented in a number of other countries and States.

RADIOTELEGRAPHY AND TELEPHONY

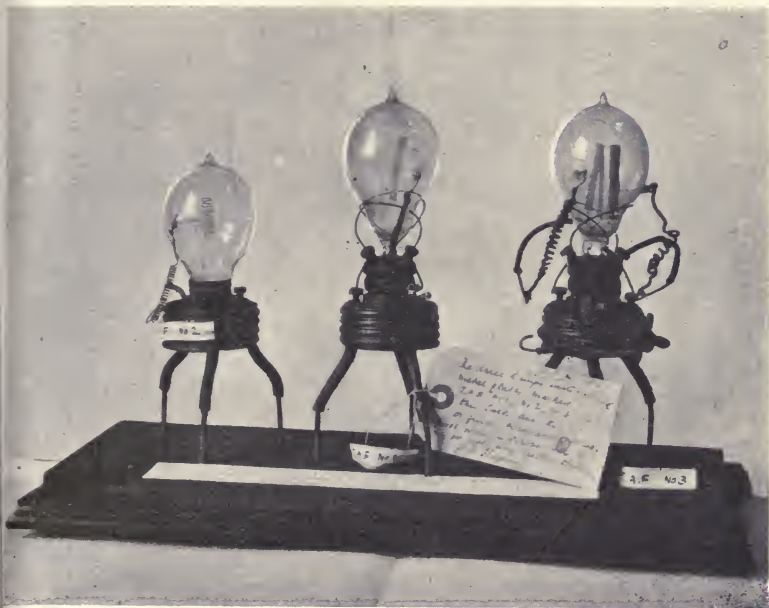

FIG. 28.—Photographs of the original Valves used by the Author for rectifying electric oscillations in 1904.

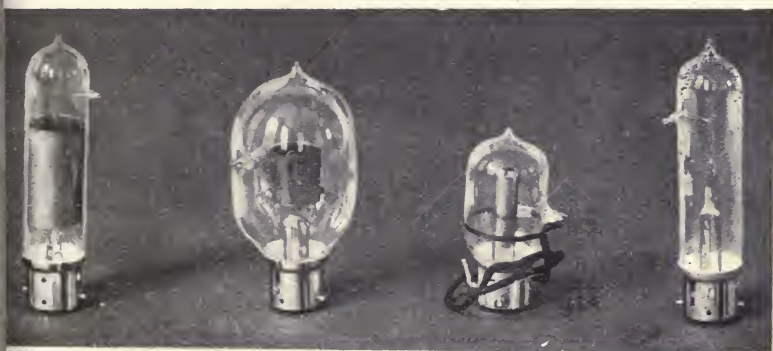

FIG. 28A.—Photographs of various types of Fleming Valve.

THE THERMIONIC VALVE IN

oscillation valve made at a later date (see also frontispiece).

The arrangements of receiving circuit, proposed and used by the author at the end of 1904 with this oscillation valve, were as shown in Figs. 29a, 29b, in which *A* is the aerial wire, *P.S.* the jigger or oscillation transformer, *C* the receiving condenser, *V* or *O* the valve, *B* the battery for the valve filament, and *T* as a current-detecting instrument, which, in the author's personal experiments, was a mirror galvanometer (Fig. 29a), but for which a telephone was soon substituted (see Fig. 29b).

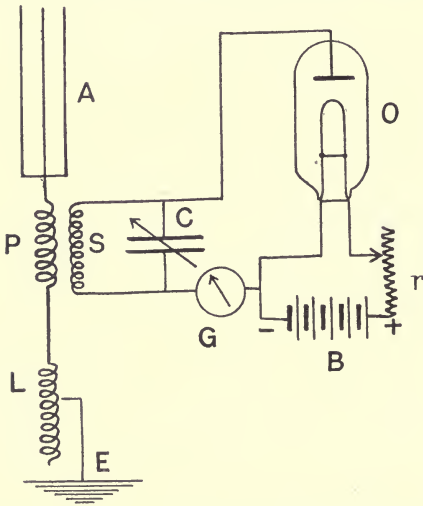

FIG. 29A.—SCHEME OF CONNECTIONS FOR USE OF AN OSCILLATION VALVE AS A DETECTOR IN WIRELESS TELEGRAPHY. *A*, Aerial Wire. *P, S*, Jigger. *C*, Tuning Condenser. *O*, Oscillation Valve. *B*, Valve Battery. *r*, Rheostat. *G*, Galvanometer or current-detecting instrument.

the incandescent filament and the metal cylinder as follows:¹

A bulb containing a 12-volt carbon filament rendered brightly incandescent by a current of about 2.7 to 3.7 amperes was employed. The filament was surrounded by an aluminium cylinder. The length of the carbon filament was 4.5 cm., its diameter 0.5 mm., and surface 70 square mm.

The aluminium cylinder had a diameter of 2 cms., a height of 2 cms., and a surface of 12.5 square cms. The filament was shaped like a horse-shoe, the distance between

¹ See J. A. Fleming, "On the Conversion of Electric Oscillations into Continuous Currents by Means of a Vacuum Valve," *Proc. Roy. Soc. Lond.*, vol. lxxvi., p. 476, 1905.

the legs being 5 mm. This filament was rendered incandescent to various degrees by applying to its terminals 8, 9, 10, and 11 volts respectively. Another insulated battery of secondary cells was employed to send a current through the vacuous space from the cylinder to the filament, connection being made with the negative terminal of the latter. The current through the vacuous space and the potential difference of the cylinder and negative end of the hot carbon filament were measured by a potentiometer. The effective resistance of the vacuous space is then taken to be the ratio of the so observed potential difference (valve P.D.) to the current (thermionic current) through the vacuum.

The results of observations are tabulated in Table I., and graphically represented in Fig 30. In these curves the vertical ordinates are the thermionic current of negative ions and the horizontal abscissæ the P.D. between the filament and collecting plate. Such a curve is called the *characteristic curve* of the valve.

The column headed P.D. gives the potential difference between the hot filament and the cylinder, that headed A gives the current through the vacuous space in milliamperes, that headed R the resistance of the space in ohms, and that headed $K10^5$ is 100,000 times the conductivity.

The result is to show that the vacuous space does not possess a constant resistance, but its conductivity increases rapidly up to a maximum and then decreases as the valve

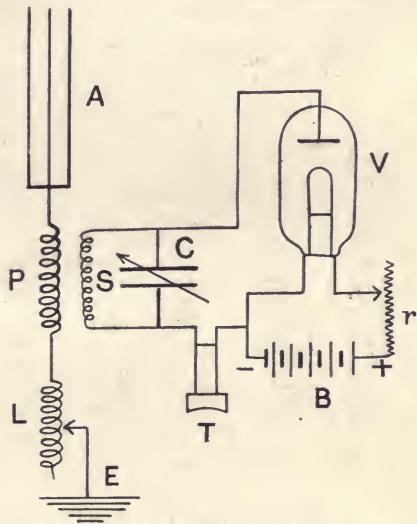

FIG. 29B.—Scheme of connections for use of an oscillation valve as a detector in wireless telegraphy, but with a telephone receiver, T, as current detecting instrument.

THE THERMIONIC VALVE IN

TABLE I.—Variation of Current through, and Conductivity of, a Vacuum Valve with Varying Electromotive Force, the Electrodes being an Incandescent Carbon Cathode and Cool Aluminium Anode.

| Carbon filament at 11 volts, 3.77 amp., 41.47 watts. | | | | Carbon filament at 10 volts, 3.44 amps., 34.43 watts. | | | |
|---|--------|--------|------------------|--|--------|--------|------------------|
| Vacuum Space. | | | | Vacuum Space. | | | |
| P.D. | A. | R. | K10 ⁵ | P.D. | A. | R. | K10 ⁵ |
| 0.6 | 0.024 | 25,000 | 4.0 | 0.7 | 0.014 | 50,000 | 2.0 |
| 5.4 | 0.264 | 20,550 | 4.86 | 2.8 | 0.073 | 38,360 | 2.6 |
| 8.8 | 0.480 | 18,330 | 5.45 | 8.2 | 0.392 | 20,920 | 4.76 |
| 18.2 | 3.880 | 4,691 | 21.4 | 12.8 | 0.824 | 15,530 | 6.56 |
| 22.9 | 26.790 | 855 | 118.1 | 16.2 | 1.739 | 9,316 | 10.70 |
| 29.1 | 28.02 | 1,038 | 96.1 | 20.1 | 5.352 | 3,756 | 26.6 |
| 37.1 | 28.426 | 1,305 | 76.6 | 23.3 | 9.68 | 2,407 | 41.4 |
| 49.0 | 26.50 | 1,719 | 58.0 | 35.9 | 10.037 | 3,577 | 28.0 |
| 70.2 | 26.87 | 2,613 | 38.3 | 49.7 | 9.794 | 5,075 | 20.0 |
| 100.0 | 24.36 | 4,105 | 25.0 | 71.6 | 8.920 | 8,027 | 12.5 |
| | | | | 100.08 | 8.331 | 12,010 | 8.32 |

Carbon filament at 9 volts, 3.112 amps., 28.0 watts.

| Vacuum Space. | | | | | | | |
|---------------|-------|---------|------------------|-------|-------|--------|------------------|
| P.D. | A. | R. | K10 ⁵ | P.D. | A. | R. | K10 ⁵ |
| 0.5 | 0.005 | 100,000 | 1.0 | 24.2 | 2.389 | 10,130 | 10.0 |
| 2.5 | 0.049 | 50,020 | 2.0 | 28.2 | 2.437 | 11,650 | 8.6 |
| 5.2 | 0.128 | 40,625 | 2.46 | 36.6 | 2.508 | 14,590 | 6.86 |
| 8.3 | 0.324 | 25,620 | 4.0 | 48.6 | 2.535 | 19,170 | 5.0 |
| 8.8 | 0.361 | 24,380 | 4.1 | 58.5 | 2.374 | 24,640 | 4.0 |
| 12.6 | 0.70 | 17,970 | 5.5 | 72.5 | 2.253 | 32,180 | 3.0 |
| 16.4 | 1.735 | 9,452 | 10.5 | 102.0 | 2.067 | 49,350 | 2.0 |
| 20.4 | 2.351 | 8,677 | 11.2 | | | | |

potential difference progressively increases. If we plot the current values as ordinates and potential difference of the valve electrodes as abscissæ, we find that the current quickly rises to a maximum or saturation value and then falls again slightly as the potential difference increases steadily. The conductivity curve, represented by the fine dotted line, also rises to a maximum and then decreases (see Fig. 30).

The facts so exhibited are well-known characteristics of gaseous conduction in rarefied gases. It may be noted that

RADIOTELEGRAPHY AND TELEPHONY

there is in these current-voltage and voltage-conduction curves a general resemblance to the magnetisation and permeability curves of iron.

To examine further the nature of this conduction the following experiments were made: If a vacuum bulb, as described, is joined up in series with a galvanometer and an electro-dynamometer and an alternating electromotive force applied to the circuit, the two instruments will both be affected. The galvanometer is, however, affected only by the resultant flux of electricity in one direction. It measures the unidirectional current. The dynamometer is affected

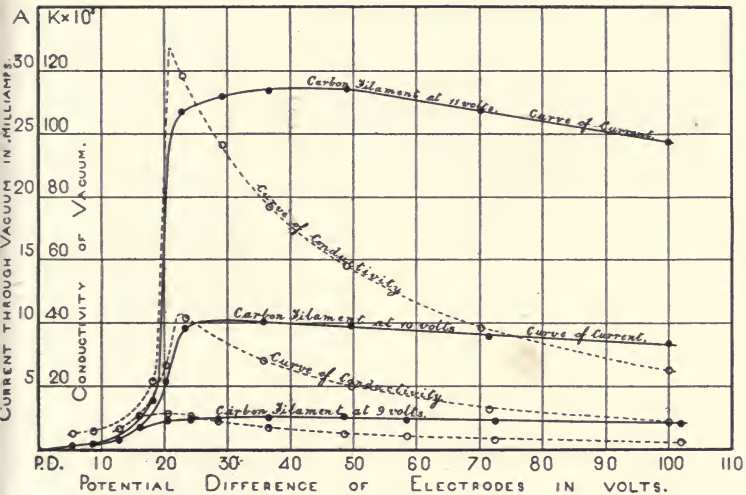

FIG. 30.—Characteristic Curves of vacuous space in an oscillation valve for various temperatures of the carbon filament.

by the bilateral flux of electricity and it measures the total or alternating current. If, therefore, the vacuous space is totally non-conducting in one direction, one half of the alternating current will be cut out. The galvanometer will read the true mean (T.M.) value of the remanent unidirectional current, and the dynamometer will read the root-mean-square (R.M.S.) value. If the conductivity in one direction is not zero, then the galvanometer will read the T.M. value of the difference of the positive and negative

currents, but the dynamometer will read the R.M.S. value of their sum.¹

In the last case, the current through the valve may be considered to be a continuous current superimposed upon an alternating current.

If we call I the maximum value of the nearly sinoidal current in one direction, and I' the maximum in the opposite direction, then we may say that the dynamometer reading (D) expressed in true current value is equal to $g(I+I')$ where g is the *amplitude factor*, and also that the galvanometer reading (G) in true current value is equal to $g/f(I-I')$ where f is the *form factor* of the current.² Hence—

$$\frac{D}{G} = f \frac{I+I'}{I-I'}, \text{ or } \frac{D/G+f}{2f} = \frac{I}{I-I'}$$

The fraction $\frac{2f}{D/G+f}$, say β , expressed as a percentage may be called the *rectifying power* of the valve, for it expresses the percentage which the actual unilateral electric flow or continuous current through the valve is of that continuous current which would flow if the unilateral conductivity were perfect.

This point was examined, as follows : A sensitive electro-dynamometer was constructed, the fixed coil having 2,000 turns of No. 47 silk-covered copper wire and the movable coil 1,000 turns. The suspension of the movable coil was by a fine flat phosphor-bronze wire at top and bottom. The deflection was observed by a mirror and scale.

This dynamometer was placed in series with a shunted movable coil galvanometer of Holden-Pitkin pattern, and the two together placed in series with a variable section of

¹ If i is the instantaneous value of a periodically varying current with maximum value I and periodic time, T , then the root-mean-square value (R.M.S. value) of i is defined to be $\left(\frac{1}{T} \int_0^T i^2 dt\right)^{\frac{1}{2}}$ and the true mean value (T.M. value) of i is defined to be $\frac{2}{T} \int_0^{\frac{1}{2}T} i dt$.

² The *form factor*, f , and *amplitude factor*, g , are the names given by the author (see *The Alternate Current Transformer*, J. A. Fleming, vol. i., p. 585, 3rd Edition) to the ratio of the R.M.S. to the T.M. value of the ordinates of a single valued periodic curve, and to the ratio of the R.M.S. value of the ordinates to the maximum value during the period.

an inductionless coil through which an alternating current was passing. A vacuum valve as above described was in series with the galvanometer and dynamometer. The alternating current was derived from an alternator giving a nearly true sinoidal electromotive force. The form factor of the electromotive force curve of this alternator was determined and found to be 1.115, that for a true sine curve being 1.111.

The vacuum valve sifted out the alternating current flow and allowed the currents in one direction to pass, but nearly stopped those in the opposite direction. The indications of the electro-dynamometer were proportional to the root-mean-square (R.M.S.) value of the sum of the two opposite currents, and that of the galvanometer to the true mean value (T.M.) of their difference. The galvanometer and dynamometer were both calibrated by a potentiometer by means of continuous current, and curves constructed to convert their scale readings to milliamperes. Then with various alternating current electromotive forces, their readings were taken when in series with a vacuum valve and recorded in Table II. below. The letter D denotes current in milliamperes as read by the calibrated dynamometer and G that read by the galvanometer. The ratio D/G is denoted by α , and the rectifying power, viz., $2f/\alpha + f$ by β .

The table shows that the value of α is not constant, but for each state of incandescence of the filament reaches a maximum which, however, does not greatly differ from the mean value of the range of currents used. If we set out the mean values of β in a curve (see Fig.

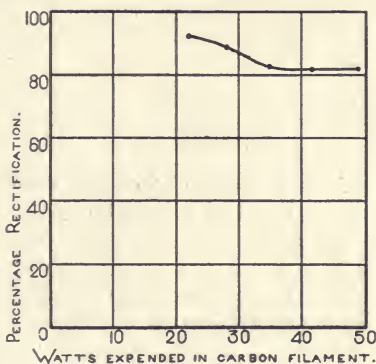

FIG. 31.

31), in terms of the power expended in heating the carbon filament, we see that the rectification is less complete in proportion as the temperature of the carbon filament increases.

THE THERMIONIC VALVE IN

TABLE II.—Ratio of Electrodynamometer (*D*) to Galvanometer (*G*) Readings in Milliampères. Form Factor of E.M.F. Curve = $1.115=f$.

| Carbon filament at 11 volts, 3.77 amps., 41.7 watts. | | | |
|---|------------|-------------------------|-----------------------|
| <i>D</i> . | <i>G</i> . | <i>D G</i> = <i>a</i> . | $2 f a + f = \beta$. |
| 0.85 | 0.57 | 1.49 | 0.86 |
| 1.33 | 0.85 | 1.56 | 0.83 |
| 1.87 | 1.16 | 1.61 | 0.82 |
| 2.30 | 1.40 | 1.64 | 0.81 |
| 3.20 | 1.88 | 1.73 | 0.78 |
| 3.52 | 2.10 | 1.68 | 0.80 |
| 4.54 | 2.81 | 1.62 | 0.82 |
| | | | } Mean = 0.82 |
| Carbon filament at 10 volts, 3.44 amps., 34.43 watts. | | | |
| 0.50 | 0.34 | 1.47 | 0.86 |
| 1.34 | 0.86 | 1.56 | 0.83 |
| 2.28 | 1.48 | 1.54 | 0.84 |
| 2.72 | 1.68 | 1.62 | 0.82 |
| 2.78 | 1.71 | 1.63 | 0.81 |
| 3.02 | 1.87 | 1.62 | 0.82 |
| 3.53 | 2.17 | 1.63 | 0.81 |
| 4.30 | 2.92 | 1.47 | 0.86 |
| 4.25 | 2.88 | 1.48 | 0.86 |
| | | | } Mean = 0.83 |
| Carbon filament at 9 volts, 3.112 amps., 28.0 watts. | | | |
| 0.40 | 0.31 | 1.29 | 0.93 |
| 0.73 | 0.50 | 1.46 | 0.87 |
| 1.28 | 0.83 | 1.54 | 0.84 |
| 1.65 | 1.15 | 1.43 | 0.88 |
| 1.82 | 1.26 | 1.44 | 0.87 |
| 1.78 | 1.26 | 1.41 | 0.88 |
| 1.93 | 1.35 | 1.43 | 0.88 |
| 1.94 | 1.41 | 1.38 | 0.89 |
| 1.87 | 1.41 | 1.38 | 0.91 |
| 1.83 | 1.39 | 1.32 | 0.92 |
| 1.73 | 1.37 | 1.26 | 0.94 |
| | | | } Mean = 0.89 |

The meaning of this last effect is not quite clear. It is in all probability connected with the fact that in the Edison experiment with the plate between the legs of the filament in a glow lamp a galvanometer connected between the plate and the negative terminal of the filament shows no current when the filament is not very brightly incandescent, but does indicate a feeble current when the temperature of the filament is raised to very bright incandescence.

We can obtain a more complete transformation of an alternating current to a continuous one by employing a differential galvanometer and two vacuum valves. These must then be arranged, as shown in Fig. 32, one circuit G_1 of the differential galvanometer is in series with one valve

V_1 and the other circuit G_2 with the other valve V_2 , but so joined up that currents flowing through the valves in opposite directions pass round the two galvanometer wires in the same direction as regards the needle and, therefore, their effects are added together on the galvanometer needle. Each valve must then have its own separate insulated battery to ignite the filament. Also, it is necessary that the connection with the oscillatory circuit must be made in both cases to the hot filament by that terminal which is in connection with the negative pole of the local battery used to ignite the filament (see Fig. 32).

In a Paper read to the Physical Society of London on March 23rd, 1906, the author exhibited a number of experiments with such valves, and showed how, in connection with

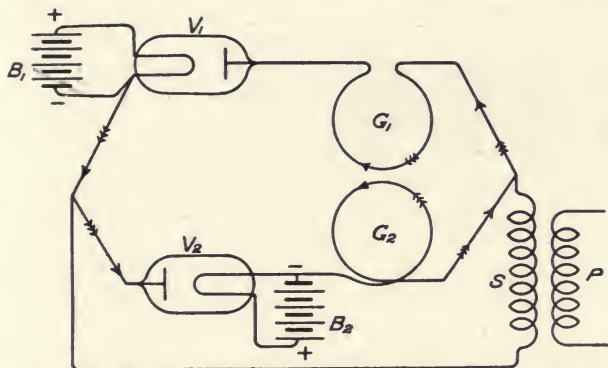

FIG. 32.—Mode of employing two oscillation valves for the complete rectification of a high-frequency electric oscillation.

a direct current galvanometer or milliammeter, it could be used as a quantitative or metrical detector of electric oscillations.¹

2. Very shortly after the publication of the above new method of rectifying and detecting electric oscillations by means of a vacuum oscillation valve in the *Proceedings of the Royal Society* (vol. lxxiv., p. 476, 1905) the author showed his experiments to Senatore Marconi, and at his request sent to him some of the oscillation valves for test between long-distance wireless stations of the Marconi Company. The

¹ See "The Construction and Use of Oscillation Valves for Rectifying High Frequency Electric Currents," J. A. Fleming, *Proc. Phys. Soc. Lond.*, vol. xx., p. 177, 1906; also *Phil. Mag.*, May, 1906.

THE THERMIONIC VALVE IN

valves first supplied were made with carbon filaments and with sheet nickel cylinders or collecting plates, the filament being of such size that it required about 12 volts to bring it to an incandescence corresponding to 3·0 watts per candle. It is not convenient to employ high voltage lamps as detectors in the case of radiotelegraphy, because this necessitates using a large number of secondary cells as a filament-heating battery. It was, in fact, soon found that for radiotelegraphic purposes a small 4-volt lamp made with metal cylinder embracing but not touching the filament was as effective as a detector as a larger lamp and required as heating battery the use of only a couple of portable storage cells. It was also found desirable to employ a small variable resistance in series with this battery and the lamp filament to regulate the temperature and thermionic emission of the latter.

Before the middle of 1905 the valves sent to Senatore Marconi were employed by him in practical wireless telegraphy, with a telephone as a signal receiving or detecting appliance, the general arrangement of the receiving circuits being as shown in Fig. 29.

In this case the operation of the valve is as follows: When a transmitter is sending out intermittent trains of feebly damped waves, these waves, when incident on a receiving aerial, set up similar but feeble trains of damped oscillations in the receiver and create oscillations of potential at the terminals of the condenser in the secondary circuit of the receiver.

If a Fleming oscillation valve have its collecting plate connected to one terminal of the condenser, whilst the other terminal of the condenser is connected through the Bell magneto telephone with the incandescent filament of the valve, then the electrical action is as follows:

When the terminal of the condenser in connection with the collecting plate becomes positively charged by the movement of electricity in one direction, this charge is at once neutralised by the negative ions which are being projected from the hot filament on to the collecting plate. Hence there is a corresponding movement of electricity through the telephone. When the condenser-plate becomes negative at the next semi-oscillation no such discharge takes place, nor movement of electricity through the

telephone. Accordingly, at each semi-oscillation of the potential at the terminals of the receiver condenser the telephone is traversed by little gushes of electricity, and these gushes integrate into a single unidirectional flow or movement for each train of oscillations or spark at the transmitter balls. If, then, the transmitter produces what is called a musical spark, or one in which the separate condenser discharges are very uniformly equispaced in tune, the corresponding small sounds heard in the Bell telephone at the receiver at each spark run together into a uniform musical note, the pitch of which is the same as that of the frequency of the spark at the transmitter. This sound is cut up into *dot* and *dash* signals on the Morse code by manipulation of the key in the transmitter circuits.

By the adoption of a spark frequency of about 500 we avail ourselves of the physiological-physical fact that for some frequency near to 700, as shown by Lord Rayleigh, the telephone *plus* the human ear is most sensitive to the interruptions of a current which does not exceed a small fraction of a microampere. Accordingly, good signals can be radiotelegraphed and received audibly by the passage of an extremely small current through the telephone, probably not more than 1 or 2 microamperes. Hence the thermionic current provided by the hot electrode in the valve need not be large, and therefore a short and low voltage filament will suffice. A filament which incandesces with 3.5 to 4 volts is generally used.

At a little later date Marconi found it to be an advantage to actuate the telephone with an induced current, and inserted a transformer or "jigger" between the telephone and the valve circuit. He joined the high-resistance circuit of this transformer, J , in series with the vacuum valve, and the low-resistance or large current circuit in series with the telephone (see Fig. 33); and he inserted a condenser, C_1 , of small capacity in series with the valve and induction coil circuit.¹ For the induction coil he employed, at first, an ordinary 10-inch induction coil, putting the high-resistance secondary circuit in series with the Fleming valve, and the low-resistance in series with the telephone receiver.

¹ See British Patent Specification No. 887 of January 12th, 1907. Guglielmo Marconi and Marconi's Wireless Telegraph Company, Limited.

THE THERMIONIC VALVE IN

One other small improvement was soon afterwards made, when the Fleming valve was put into practical operation in radiotelegraphy by Marconi's Wireless Telegraph Company. The author had frequently observed in his early experiments on the "Edison effect," in 1896, the great sensitiveness of the thermionic current to the action of a magnet near the lamp, and also somewhat later to electrically-charged bodies held near the bulb. The ions projected from the

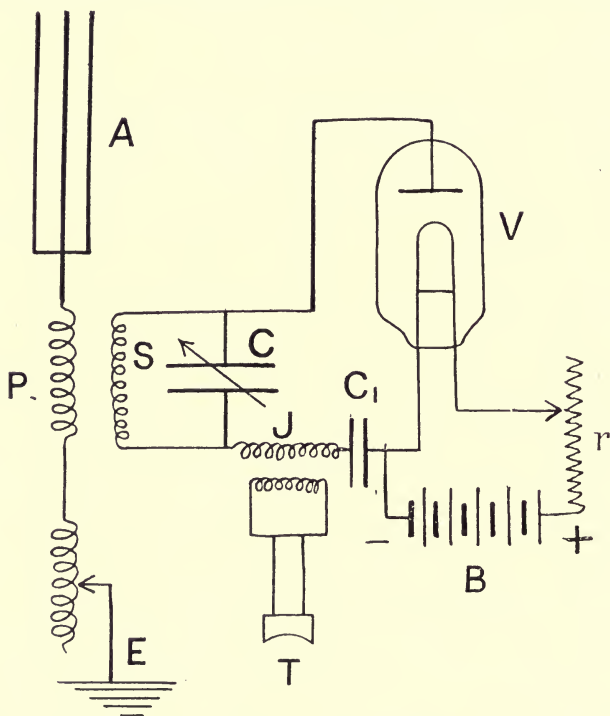

FIG. 33.—MODE OF EMPLOYING AN OSCILLATION VALVE, V, AS A DETECTOR IN WIRELESS TELEGRAPHY.

B, Valve Battery. J, Jigger. C, Tuning Condenser. A, Aerial. C₁, Receiving Condenser. T, Telephone Receiver inductively coupled to valve circuit.

filament are deflected from their path either by magnetic or electric fields. Hence a Fleming valve joined in series with a sensitive mirror galvanometer with a steady E.M.F. applied to force a negative current from the hot filament

to the collecting plate through the vacuous space forms a very sensitive electrometer, provided the E.M.F. is adjusted so as to correspond to a point near the place where the thermionic current begins to rise very rapidly, as shown by the characteristic curves (see Fig. 30). If an electrified ebonite rod or stick of sealing wax is held near a valve when in action it will generally make a very considerable reduction in the current indicated by the galvanometer.

It was therefore found desirable to enclose the valves in an outer case of copper gauze and to connect this to the earth, to prevent any disturbance of the thermionic current by electrostatic induction from neighbouring electric charges. A practical pattern of Fleming oscillation valve which then came into use for radiotelegraphic reception was made as follows :

The enclosing glass vessel consisted of a tube of glass about 1 inch in diameter and 3.5 to 4 inches long. This was equipped at one end with a stem carrying a horseshoe carbon filament of carbon, or later of tungsten wire. The filament was of such length as to be brightly incandescent at some voltage between 10 and 12 volts. This filament is surrounded by a cylinder of copper or nickel sheet attached to a platinum wire sealed through the glass. In a type of valve once used by the Marconi Company the collecting plate is a single flat plate of copper about 1 cm. square held near to the carbon or tungsten loop which forms the filament of the valve with the flat surface of collecting plate parallel to and a few millimetres from the plane of the horseshoe filament loop. The lamp is finished off with the usual bayonet or bottom contact pins so as to work in a standard electric lamp socket (see Fig. 34).

The tubular lamp is sometimes enclosed in a copper gauze screen bound closely to the glass, and this screen is connected to earth when the valve is in use (see Fig. 34). The Marconi Company now fit up a valve-receiving set in which two valves are arranged to work off the same lamp battery, either lamp being brought into use by means of a throw-over switch at pleasure. This provides for the accident of a valve filament burning out during the reception of a message, as the operator can instantly throw over the switch and bring the spare valve into use (see Fig. 35). These valves are placed in sockets on a box which contains

THE THERMIONIC VALVE IN

the variable resistance for adjusting the filament current, and also the condenser and current transformer, as used in Senatore Marconi's circuits specified in his British Specifi-

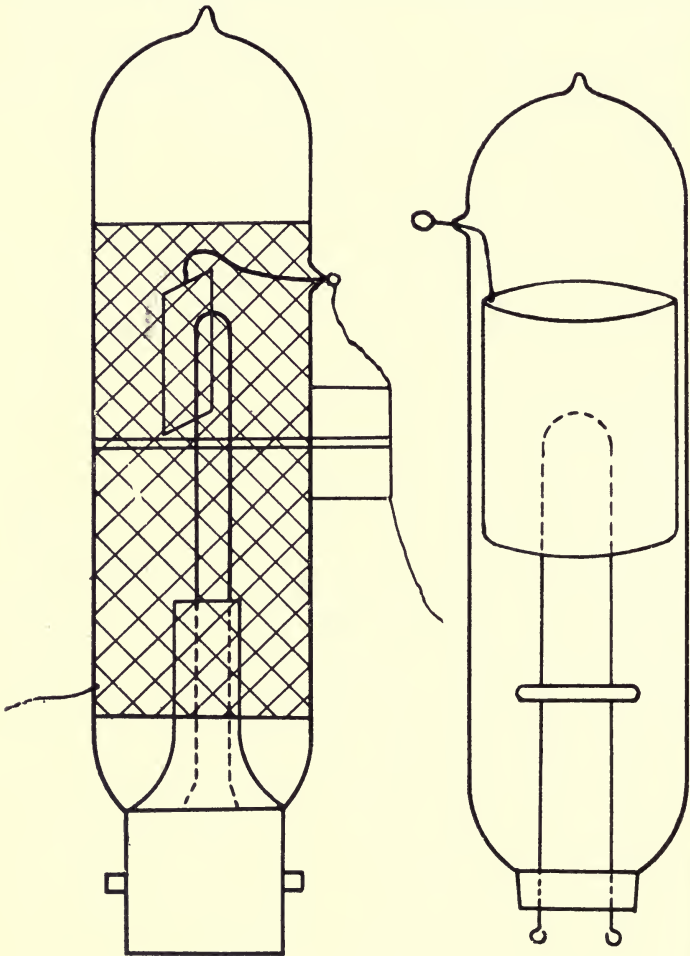

FIG. 34.

FIG. 34A.

FIG. 34.—Types of Fleming Oscillation Valves employed in Wireless Telegraphy. Fig. 34 shows the valve (full size) with copper-gauze shield for protecting from external electric fields.

cation, No. 887 of 1907 (see Fig. 33). Each valve has the usual brass collar for fitting the bayonet socket.

This receiving set has terminals outside the box for the working battery, for the telephone receiver and for connection to the terminals of the condenser in the receiver circuits, which is generally a Marconi tuner.¹

In 1911 Dr. R. S. Willows and Mr. S. E. Hill² described some experiments with a Fleming valve, in which the heated element was a platinum strip coated with lime; in fact a Wehnelt cathode, as it is called. This form of cathode, as already mentioned in Chapter I., was found by Wehnelt to emit copiously negative electrons when the platinum is raised to a white heat by a current. Messrs.

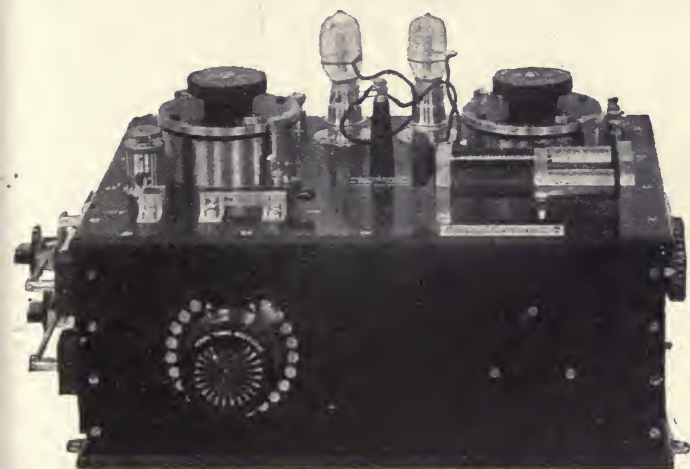

FIG. 35.—Fleming Valve Receiving Set, as made and used by Marconi's Wireless Telegraph Company, Ltd.

Willows and Hill prepared a valve in which the cathode was a lime-coated platinum strip and the anode plate was coated with aluminic phosphate, which gives out positive ions when raised to a dull red heat. Although such coated cathode and anode plates may evolve larger thermionic currents than the simple carbon or tungsten filaments, yet there is a tendency for the coatings to fall off the platinum plates in course of use. Moreover, such coated cathodes

¹ For details of the Marconi tuner, see J. A. Fleming, *Principles of Electric Wave Telegraphy and Telephony*, 3rd Edition, Part III., chap. vii.

² See R. S. Willows and S. E. Hill, *The Electrician*, vol. lxxviii., p. 302, 1911, "Vacuum Oscillation Detectors."

and anodes cannot be freed sufficiently from occluded gases in the process of manufacture. Hence the vacuum is generally not very high, and is variable. This introduces irregularities in working and non-uniformity in behaviour in different valves, due to the predominance of gaseous ionisation in the operation. Dr. Willows and Mr. Hill noted one interesting fact with this valve. They connected the cathode and anode outside the valve by a circuit in which was an ammeter and a battery, the E.M.F. of which could be varied, and also an oscillation transformer was inserted, so as to impose an oscillatory E.M.F. on the steady E.M.F. Tugman had already noted (see *Physical Review*, vol. xxix., p. 154, 1909) that under these conditions the addition of an oscillatory E.M.F. increased the current flowing, if the battery E.M.F. was small, but decreased it if it was made larger. Willows and Hill confirmed this fact, but also noticed that when the steady battery E.M.F. was still more increased the total current became 1,000 times greater than that produced by rectifying the oscillation without the introduction of the steady battery E.M.F.

3. Very soon after the first application of this oscillation valve in radiotelegraphy the author began to study more carefully the form of the characteristic curves of these valves, with the object of finding the condition of greatest sensitiveness and also of manufacturing them with uniformity. For this purpose a large number of such valves were made, many of them kindly furnished by Mr. C. H. Stearn, employing his special type of leuconium filament or else tungsten wire. The advantages of tungsten wire for the hot element in a thermionic valve were mentioned by the author in a British Patent Specification, No. 13,518 of June 25th, 1908. The characteristic curves of many tungsten and carbon filament valves were delineated as follows: The lamp filament was incandesced by a constant E.M.F., and another E.M.F. varying from 0 to 100 volts was inserted in an external circuit connecting the plate with the negative terminal of the filament-heating battery. This auxiliary E.M.F. was applied so as to make the plate positive. The current was read by a milliamperemeter. The conductivity of the vacuous space was calculated from the ratio of this current to the P.D. between filament and cylinder. The results were set out graphically as in the curve in Fig. 36. The

firm line is the current curve, and the dotted line the conductivity curve in terms of applied voltage. It will be seen that the current rises slowly at first, then rushes up to a maximum and then falls off again as the P.D. between filament and cylinder is steadily increased. If, for shortness, we may call the latter potential difference the valve P.D. and the P.D. on the filament ends the filament P.D., we can then say that when the valve P.D. reaches a certain value, which is generally near the filament P.D., the thermionic current begins to rise with great rapidity. This is partly due to ionisation of residual gas molecules

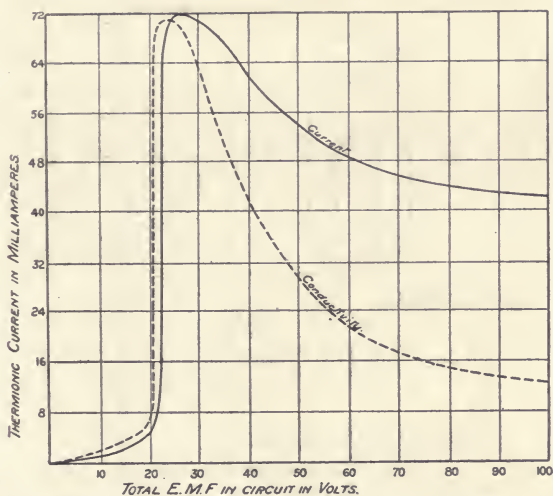

FIG. 36.—Characteristic Curve and Conductivity Curve of a Two-electrode Valve. The horizontal abscissæ are the electromotive force acting between the hot and cold electrodes and the ordinates, the corresponding thermionic currents.

by the large momentum imparted by the increasing electric force to the negative ions escaping from the filament. The falling off in the thermionic current, when the impressed E.M.F. acting across the vacuous space is still more increased, may be due to the great accumulation of negative ions on and near the collecting plate and, as a result, the creation of a space charge giving a reverse electric force which reduces the resultant or effective P.D. between the filament and the plate.

THE THERMIONIC VALVE IN

To examine more carefully the lower part of this characteristic curve another arrangement was adopted. The valve filament was made incandescent by the current from a battery, B , which passed through a variable resistance, r , and through the filament. The terminals of this battery were also connected by a high resistance, R , of several hundred ohms. On this was a sliding contact, a (see Fig. 37). The collecting plate, or cylinder, of the valve was joined through a milliammeter, G , with this sliding contact. Hence, by shifting the contact the P.D. between filament and plate could be varied, and with it the thermionic current.

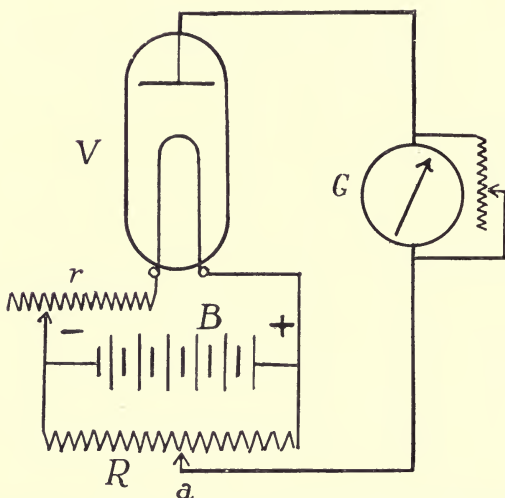

FIG. 37.—Scheme of Connections for Delineating Characteristic Curve of Two-electrode Valves.

This current was then plotted out in milliamperes in terms of the voltage or P.D. reckoned from the negative end of the battery. Fig. 38 shows one such characteristic curve. It was then found that this curve differed somewhat for various valves, being dependent upon the degree of vacuum and nature of the filament. In most cases this curve had changes of curvature at various points. These were delineated by drawing a second differential curve as follows: The slope of the characteristic curve was measured by a protractor at each point, and a curve con-

RADIOTELEGRAPHY AND TELEPHONY

structed, of which the ordinates are the slopes of the characteristic curve to corresponding ordinates. Then this slope curve was treated in the same way, which gave a second curve, whose ordinates were proportional to the second differential (d^2y/dx^2) of the ordinates (y) of the characteristic curve, but plotted to the same abscissa (x). The ordinates of the second differential curve therefore gave a measure of the curvature of original curve or rate of change of its slope. This second differential curve is represented by the dotted line in Fig. 38. It was found

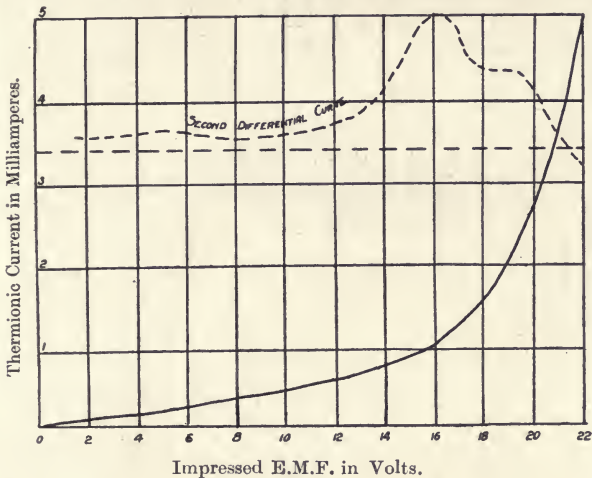

FIG. 38.—Lower part of the Characteristic Curve (firm line) of a two-electrode valve and corresponding second differential curve (dotted line).

that in most cases the characteristic curve started from a point about half a volt on the negative side of the zero.

This suggested to the author another method of operating the valve as a detector. If the applied steady voltage between the filament and plate has such a value that it corresponds to a point of change of slope on the characteristic curve, then, if by means of an inductive coupling an oscillatory E.M.F. from any source is superimposed on this steady voltage, the mean value of the thermionic current will suddenly increase, and a telephone inserted in the external circuit of filament and plate will

THE THERMIONIC VALVE IN

give a sound. The arrangements required on this scheme for so using the valve as a wave detector are as shown in Fig. 39, taken from the author's specification.¹

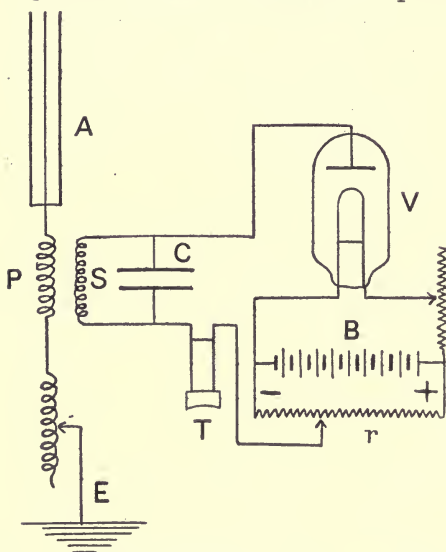

FIG. 39.—THE AUTHOR'S SECOND METHOD OF USING AN OSCILLATION VALVE AS A DETECTOR IN WIRELESS TELEGRAPHY, MAKING USE OF CHANGE OF CURVATURE IN THE CHARACTERISTIC CURVE.

V, Valve. B, Valve Battery. *r*, High Resistance with Sliding Contact. T, Telephone. A, Aerial. C, Receiving Condenser.

manufacture with certainty this peculiarity of the characteristic. Our methods of measuring and testing residual gas pressure or density in high vacua are still very imperfect, and the absorption by, and evolution of, gas from the filament and plate is irregular and not under control.

4. The experiments conducted in the author's laboratory between 1905 and 1908 had rendered it evident that constancy in results must therefore be dependent upon the employment of a very high vacuum in the bulb.

It was quite clear that many of the irregular effects found

¹ See J. A. Fleming, British Patent Specification No. 13,518 of June 25th, 1908; also United States Specification No. 945,619, application of January 2nd, 1909.

in the actual vacuum values used depended upon ionisation of the residual gas, and that to obtain uniform results exceedingly high vacua must be obtained. The author had this matter clearly before his mind in drafting the patent specifications covering the original invention. In the specification of the British patent granted to the author, No. 24,850, of 1904, covering the invention of this valve on page 3, line 46, the author says: "As a very high vacuum should be obtained in the bulb, and as a considerable quantity of air is occluded in the conductors, these should be heated when the bulb is being exhausted. The filament can be conveniently heated by passing a current through it, whilst the cylinder can be heated by surrounding the bulb with a resistance coil through which a current is passed, the whole being enclosed in a box lined with asbestos, or the like. When, as hereafter described, the cylinder is replaced by any form of conductor which can be heated by passing a current through it, this method is usually more convenient than that just described."

On page 4, line 38, of the same specification the author says: "In place of using a metallic cylinder, surrounding a carbon loop filament, I sometimes use a number of carbon filaments. Some of these are heated by means of an electric current and become the hot conductor of the oscillation valve, and the others remain cold and form the cold conductor; or the metal cylinder may be replaced by a cylinder of meerschaum, or the like, having wound helically upon it a narrow ribbon of metallic foil."

Precisely the same statements were made in the corresponding United States Patent Specification, No. 803,684. It is therefore perfectly clear that the author recognised the advantages of a high vacuum, and of the elimination of all occluded gases from the plates and filament.

Nevertheless, the attainment of perfection in any manufactured article is limited by that of the tools at disposal. At the time that these experiments were being made our means of making high vacua were chiefly the various forms of Sprengel-mercury pump and types of mercury pump making a repeated Torricellian vacuum.

The valuable Gaede molecular mechanical pump had not then made its appearance. The high vacua obtainable by Sir James Dewar's process of cooling charcoal placed in the

THE THERMIONIC VALVE IN

vessel to be exhausted by means of liquid air, mentioned at the end of this chapter, presupposes the possession of a plant for making supplies of liquid air in any quantity.

Hence the utmost that could be done then was to obtain such vacua in the valves as was usual in the manufacture of incandescent lamps. When, however, we recall to mind that in one cubic centimetre of air at 0° C. and 760 mm. there are about 2.7×10^{19} molecules it will be seen that even if we make a vacuum of 0.0001 of a millimetre of mercury, or $1/7,600,000$ of an atmosphere, this exhaustion still leaves at least 3 million million molecules ($=3 \times 10^{12}$) present in every cubic centimetre, or about 10,000 molecules to the linear centimetre. In other words, in a very high vacuum of 0.0001 mm. there are still 1,000 molecules per linear mm. in every direction.

What the author was unable to achieve in 1905 or 6 subsequent experimentalists possessed of better appliances and the resources of the research laboratory of a great manufacturing corporation in the United States have been able to accomplish.

5. An interesting account has been given by Dr. Irving Langmuir of the work done on this subject in the research laboratories of the General Electric Company, Schenectady, U.S.A., in a paper read to the Institute of Radio Engineers, New York, April 7th, 1915, entitled "The Pure Electron Discharge."¹ In this work the suggestions and instructions of the author as to the precautions to be taken in the construction of oscillation valves were carried out with great thoroughness to their logical issue, and the result has been the production of what may be called an ideally perfect Fleming Valve, which highly exhausted valve, for reasons not very forceful, has been rechristened a Kenotron. When an already used instrument is called by a new name the public are led to believe that there is some difference in principle and not merely in degree from pre-existing examples of it. In this case the appliance denominated a kenotron is certainly a Fleming valve, but precautions are taken in making it to push the exhaustion of the air from the bulb to

¹ See *Proceedings of the Institute of Radio Engineers*, vol. iii., p. 261, September, 1915; see also British Patent Specification No. 15,788 of 1914. Improvements in and relating to Electrical Vacuum Discharge Devices. The British Thomson Houston Company, Limited.

its utmost limits. When this is the case the electrons emitted from the incandescent filament reach the anode or collecting plate without more than a very small number of collisions with residual gas molecules and gas ionisation phenomena are absent. This, however, does not seem to furnish a sufficient warrant for a special name for a high vacuum valve.

In the case of X-ray bulbs there is a well marked difference between bulbs with very high vacuum, which are usually called *hard* tubes, and bulbs with a less perfect vacuum, which are called *soft* tubes. Each variety has a special advantage.

So also with oscillation valves: they may be either *soft* or *hard* according to the degree of vacuum, and for some purposes a hard valve is best, and for others a soft valve; but this is a quantitative and not a qualitative difference.

Dr. Langmuir begins his paper by noting the fact that in modern high vacuum tungsten wire lamps in which the temperature of the filament approaches $2,500^{\circ}$ C. or more the thermionic emission from the filament, which, according to Richardson's formula, should be at the rate of some amperes per sq. cm. of filament surface, is not in accordance with the thus predetermined value.

Experience shows that the current flowing across the vacuous space in a good highly insulated tungsten lamp is very small. This was found to be due not to any inability of the filament to emit electrons, but to the fact that when the space is, so to speak, saturated with electrons any further emission from the filament is stopped because electrons are driven back on the hot surface as fast as they escape from it, unless the filament is brought to a sufficiently large negative potential to repel them.

Dr. Langmuir found, by experiments made in a very perfect vacuum with a hot cathode and cold anode of tungsten, that if a constant P.D. is put on the electrodes and the temperature of the cathode steadily raised the thermionic current first rises in accordance with Richardson's law, but then at a certain temperature depending on the P.D. the current becomes constant and independent of the temperature and does not increase (see Fig. 40).

The curve representing the thermionic current as a function of temperature therefore consists of two parts:

THE THERMIONIC VALVE IN

first, a part in which Richardson's equation applies and in which the current is saturated and independent of voltage, and, second, a part in which the current is independent of temperature. In this latter part the current is again determined by the voltage and increases with it. The explanation of this is to be found in the fact that the electrons carrying the current between the electrodes

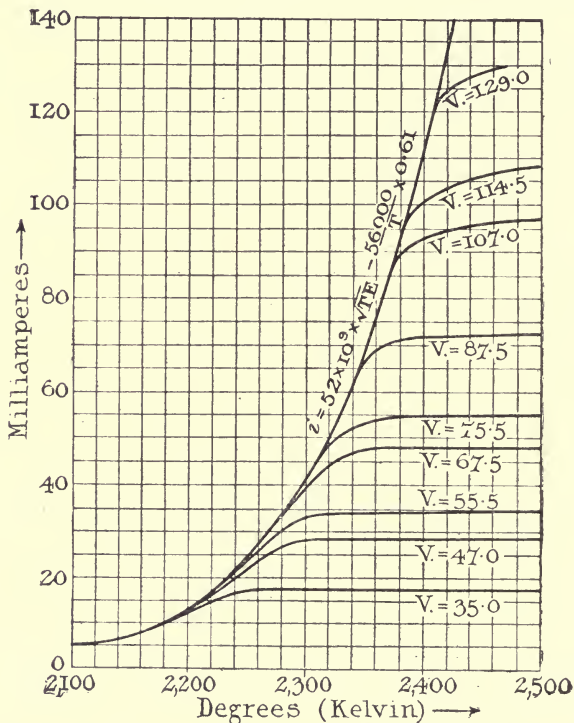

FIG. 40.—Curves given by Dr. Langmuir showing the Thermionic Current of a High Vacuum Valve in terms of absolute Temperature (Kelvin) Degrees for various Impressed Voltages.

constitute a *space charge* which repels other electrons trying to escape from the filament, so that no more come out, even if the temperature is raised, unless the voltage is also raised.

In a very high vacuum there is therefore a perfectly definite relation between the three variables—temperature of the hot cathode, thermionic current, and voltage or potential difference of the hot and cold electrodes.

RADIOTELEGRAPHY AND TELEPHONY

If traces of residual gas are present then the impact on its molecules of the electrons emitted from the hot body, now called negative thermions, will give rise to positive and negative gaseous ions. These positive ions are drawn by electric attraction to the hot cathode and disintegrate it in time. Also the ionisation increases greatly the current for a given P.D. of hot and cold electrode or, what is the same thing, reduces the P.D. required for a given current. If the gas pressure exceeds 0.0001 mm. then irregularities are introduced into the form of the characteristic curve, and with pressures of about 0.001 mm. the current may jump from one value to another, even when the P.D. remains constant, as already noticed by the author.

If, however, the vacuum is made as high as a millionth or, better, a hundred millionth of a millimetre of mercury, which needs extraordinary precautions, then the phenomena consequent on ionisation of residual gas are absent and the whole effects are due to pure electron emission from the hot cathode.

The thermionic current in milliamperes emitted per square centimetre of surface from a tungsten incandescent filament placed in the axis of a metal collecting cylinder in a "perfect" vacuum has been found by Langmuir to be expressed by the formula

$$\frac{\text{milliamperes}}{\text{square cms.}} = i = 29.6 \times 10^9 \sqrt{T} \epsilon^{-52500/T}$$

where T is the absolute temperature of the filament.¹

Langmuir also states that in a highly perfect vacuum there is a definite relation between the thermionic current (i) and the potential difference (V) of the hot and cold electrodes, such that $i = CV^{\frac{3}{2}}$, where C is some constant depending on the form and distance of the electrodes. Hence, in the case of a pure electron discharge, the square of the thermionic current varies as the cube of the electrode potential difference.

This equation, he states (*loc. cit.*), has been found to give results in accordance with experiment when there is no

¹ It is usual to express absolute temperatures by putting the letter K (K=Kelvin) after the number. Thus 2,000 deg. K=2,000 deg. absolute = (2,000-273) deg. Centigrade.

THE THERMIONIC VALVE IN

appreciable residual gas ionisation producing positive ions. Extremely minute traces of gas may lead to the formation of a sufficient number of positive ions to reduce greatly the space charge of electrons and thus increase the current carrying power of the space.

The characteristics of this positive ionisation are the appearance of a blue glow in the tube or vessel, the disintegration of the hot cathode and the fact that the thermionic current increases in an irregular manner with the voltage applied to the electrodes and not simply according to the $3/2$ power of the P.D.

When the exhaustion of the bulb is sufficiently high to prevent anything but the pure electron emission from the hot cathode, the path of the cathode rays is quite invisible, and it is possible to obtain very large thermionic currents without damage to the electrodes, and also to reproduce with equal qualities a required valve.

6. Starting from these researches the General Electric Company of America have been able to make a very perfect type of thermionic rectifier, in which gas ionisation is prevented and pure electron transmission from the hot to the cold electrode the only effect.¹

An interesting account of this work has been given by Dr. Saul Dushman in the *General Electric Review* for March, 1915, vol. xviii., p. 156. The chief object of this work was to make a thermionic rectifier which should be constant and durable in action, carry as large a current as possible and endure the application to it of a high voltage.

First, as regards current carrying capacity, Richardson's formula with Langmuir's constants gives us the relation

¹ Some who have written on this subject have endeavoured to restrict the term "Fleming Valve" to a thermionic rectifier in which the vacuum is not high enough to obviate all gas ionisation and accompanying phenomena. Anyone who will read the author's patent specifications or his writings in 1905 and 1906 describing his oscillation valve, such as an article in *Technics* for April, 1905, will see that the author made no such restrictions. He always contemplated the operation as essentially due to electronic emission. The making of a more perfect vacuum in a valve than was possible in 1904 or 1905 does not constitute a new invention or justify a new name, but is simply a more complete carrying out of the author's instructions in practice than was possible at that date.

RADIOTELEGRAPHY AND TELEPHONY

between current density in milliamperes per sq. cm. of filament surface, i , and absolute temperature T , as follows :

| T . | | | | | i = milliamperes per sq. cm. |
|----------------|-----|-----|-----|-----|--------------------------------|
| 2,000 K | ... | ... | ... | ... | 4.2 |
| 2,100 | ... | ... | ... | ... | 15.1 |
| 2,200 | ... | ... | ... | ... | 48.3 |
| 2,300 | ... | ... | ... | ... | 137.7 |
| 2,400 | ... | ... | ... | ... | 364.8 |
| 2,500 | ... | ... | ... | ... | 891.0 |
| 2,600 | ... | ... | ... | ... | 2,044.0 |

The current thus rises very rapidly with the absolute temperature of the filament. Dushman then gives a table showing the relation of filament diameter in mils. (1 mil. = .001 in.), the safe working temperature, the current in milliamperes per centimetre of length of such filament, and the power taken up in watts per centimetre of length of the filament. The "safe" temperature is that at which it will last 2,000 hours.

| Diameter of filament in mils. | Safe Temperature absolute. | Thermionic current in milliamperes per centum of Length. | Watts per centum of Length. |
|-------------------------------|----------------------------|--|-----------------------------|
| | Deg. K. | | |
| 5 | 2,475 | 30 | 3.1 |
| 7 | 2,500 | 50 | 4.6 |
| 10 | 2,550 | 100 | 7.2 |
| 15 | 2,575 | 200 | 11.3 |

Thus a 5-mil. filament of tungsten in a very high vacuum run at a temperature of $2,400^{\circ}$ K., which corresponds to 1 watt per candle, has a life of 4,000 hours. The electron emission is 15 milliamperes per centimetre of length and the power required to be put into the filament is 4.5 watts per cm. of length. Where thermionic currents of 100 milliamperes or more are required it is better to use a 7 or 10-mil. filament.

There will then be a volt-drop, V , or P.D. between the hot and cold electrode expressed by the formula $i = CV^{\frac{3}{2}}$.

Suppose such a high-vacuum valve placed in series with a resistance and let an alternating electromotive force, E , be applied. Let i_s be the current rectified; also let V denote the volt-drop in the valve and R the external resistance, then $i_s = C(E - i_s R)^{\frac{3}{2}}$. With constant value of E the current

THE THERMIONIC VALVE IN

rectified increases as R is decreased, until i_s has attained the value i , corresponding to saturation thermionic current at the temperature at which the filament is running. If R is still more decreased the current, i , will remain constant, and the volt-drop in the valve is that available above the volt-drop, $i_s R$, in the external circuit. If the resistance is therefore removed or short-circuited the total external voltage is taken up in the valve and the energy may be expended in melting the anode or collecting plate.

It must be remembered that in high vacuum valves the emitted electrons expend no energy in ionising residual gas molecules, and therefore expend it all in heating the anode, just as rifle bullets heat the target against which they strike. If the anode becomes too hot it also itself emits electrons, and then the rectification becomes imperfect. The arrangement and size of the anode or collector surface must, therefore, be such that with the current required the volt-drop in the valve is not sufficient to expend on the anode energy enough to overheat it.

If V is the volt-drop in the valve and i the thermionic current, then iV is the measure of the electronic energy expended per second against the anode and converted into heat.

The expenditure of power against the anode should not exceed about 10 watts per sq. cm. of anode surface. This corresponds to an anode temperature of about $1,600^\circ \text{K}$. ($=1,600^\circ$ absolute temperature)—that is, a bright red heat. At this temperature the electron emission from the anode would be only 0.02 milliamperes per sq. cm. Another matter which received attention in the design of the kenotron was the electrostatic attraction between the incandescent filaments and the cold anode. Hence, in the case of high vacuum thermionic rectifiers, in which there is a P.D. of 20,000 volts

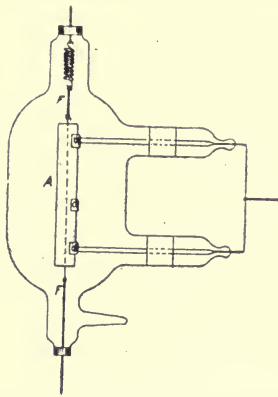

FIG. 41.—Kenotron or High-Vacuum Fleming Oscillation Valve as made by the General Electric Company of America, with Straight Filament and Cylindrical Anode.

or so between the hot and cold electrodes, the filament must be so supported that it cannot be pulled over and make contact with the cold electrode.

The General Electric Company of America have produced several types of these high vacuum thermionic rectifiers. Fig. 41 shows a valve in which a molybdenum cylinder, about 10 cms. long and 1.27 cm. diameter, surrounds a straight tungsten filament. The filament is made of 10-mil. drawn tungsten wire. At a temperature of $2,550^{\circ}$ K. the maximum thermionic current obtainable from it is 400 milliamperes and the P.D. drop in the valve to produce this current must be 145 volts, whilst the total energy taken up in the apparatus is 130 watts or 72 watts for heating the filament and 58 in heating the anode. The anode has a surface of about 80 square centimetres. This power would just suffice to heat it to a dull red heat. The valve is therefore capable of rectifying $0.4 \times 15,000 = 6$ kilowatts, and the power waste in the tube is about 2 per cent. of this transmitted power. In the case of smaller rectifiers the filament may be a small spiral of tungsten wire having held over it a molybdenum cap like a thimble which does not touch the filament (see Fig. 42). Such a valve is suitable for carrying up to 100 milliamperes with valve P.D. of 10,000 volts.



FIG. 42.—Small Kenotron or High-Vacuum Fleming Oscillation Valve as made by the General Electric Company of America.

In other cases the filament is a W or zig-zag pattern of wire held in a frame and the anode is in the form of a pair of plates placed on either side of it (see Fig. 43). In this last pattern the current-carrying capacity can be up to 400 milliamperes at 25,000 volts P.D. between filament and anode, or a rectified power of 10 kw., with a power dissipation of about 2 per cent., or 200 watts, in the valve itself.

For higher voltages up to 100,000 the cylindrical anode is the best. Up to the present rectifiers of this type have been constructed for direct current voltages as high as 100,000 and for currents up to 1.5 amperes.

THE THERMIONIC VALVE IN

The oscillogram shown in Fig. 44 shows the complete rectification effected by such a valve operating on a low-frequency alternating current of frequency 60, and an E.M.F. of 122 volts. The upper curve shows the generator unrectified E.M.F. curve and the lower the rectified current through the valve.

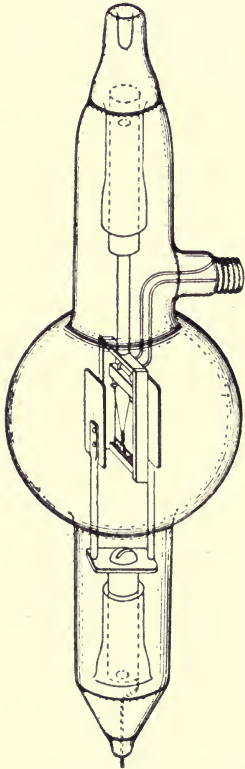

FIG. 43.—Large Kenotron or High-Vacuum Oscillation Valve as made by the General Electric Company of America.

A useful property of high vacuum valves is that any number can be arranged in parallel and will each contribute their proper share to the resulting unidirectional current provided that they are all placed in parallel with one and the same external resistance.

The high vacuum valve thus possesses two advantages over the mercury arc rectifier in that it can not only be operated at a higher voltage, but that valves can be yoked in parallel. Such valves may therefore be used to produce small high voltage direct or unidirectional currents from transformers for X-ray work or for the precipitation of smoke.

Dr. S. Dushman also suggests that it would be possible to use a large number of high vacuum valves, say 100 10-kw. size, to transmit power by direct currents on the Thury system, employing step-up transformers to raise a low A.C. voltage to the required pressure.

7. Other experimentalists and workers have also contributed to the cultivation of the fields laid open by the above-described researches.

Dr. A. Wehnelt obtained a German patent, No. 157,845, Klasse 21g, on January 15th, 1904, for an electrical valve (*Elektrisches Ventil*), using as a cathode an incandescent metal strip covered with oxides of some earth such as lime,

baryta, etc., which earthy oxides he had shown gave off negative ions when strongly heated. He gave no details of the construction of this valve and no application of it to any technical purpose in the above-mentioned specification of his invention.

In October, 1905, nearly a year after the date of the author's British patent, No. 24,850 of 1904, and ten months after the publication in the *Proceedings of the Royal Society of London* of an account of the author's application of a high vacuum valve as a

rectifier in wireless telegraphy, Wehnelt presented a paper to the Physical Institute of the University of Erlangen entitled "An Electrical Valve" ("*Ein Elektrisches Ventilsohr*") in which he describes the application of his vacuum tube having an incandescent lime-covered cathode for the purpose of rectifying alternating currents and as a detector in wireless

telegraphy. But although by that time he must surely have been acquainted with the author's published work on this subject in the *Proceedings of the Royal Society* (published in February, 1905), and doubtless with the author's German patent, granted April 12th, 1905, Dr. Wehnelt makes not the slightest reference in this paper to the author's name or prior application of a carbon or tungsten incandescent lamp with metal collecting plate or cylinder in the exhausted bulb as a detector of oscillations in a wireless telegraph receiver.

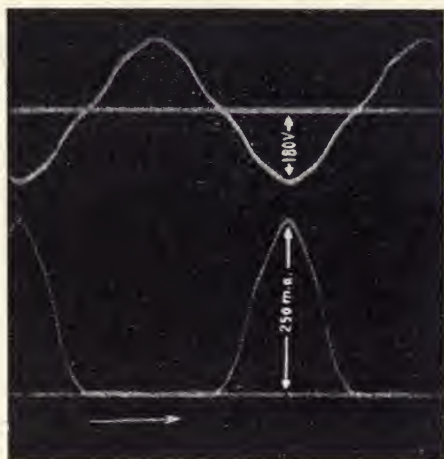

FIG. 44.—Oscillogram, showing by the Upper Curve the Wave Form of an Alternating Electromotive Force, and by the Lower Curve the Complete Rectification by a High-vacuum Valve or Kenotron.

Wehnelt had applied for and obtained in January, 1904,

a German patent, No. 157,845, for an electric valve consisting of a vacuum tube having an oxide-coated cathode and a cold metal anode and had specified this tube as a rectifier of ordinary single or polyphase alternating currents but he makes no mention in the specification or the claim of its use for rectifying high-frequency currents, and, as we have seen, the latter is not an obvious deduction from the low-frequency rectifying power. Moreover, the author had shown in 1890 (see *Proceedings, Royal Society, London*, vol. xlvii., p. 120) that when an ordinary carbon filament with Edison plate in the bulb is rendered incandescent by a low-frequency alternating current the "Edison effect" current is a direct current.

Profiting, no doubt, by the knowledge first given by the author in 1890 that the "Edison effect" can take place between an incandescent filament and a cold metal plate very near to it in air at ordinary pressure, others have constructed rectifying valves in which the incandescent filament was placed in a bulb not very highly exhausted.

The employment for illumination of tungsten filament lamps in which the bulb is not highly exhausted, but filled with an inert gas such as nitrogen or argon at a low pressure, may, doubtless, have also suggested the trial of a similarly constructed oscillation valve or rectifier. In this case the anode or collecting plate must be placed very near the filament and the gas pressure in the bulb reduced to about 3 mm. of mercury. The current between cathode and anode is then chiefly due to gas ionisation.

As an example of such a low vacuum valve, filled with a rarefied inert gas, we may mention that type of valve manufactured by the General Electric Company of the United States, which comprises a tungsten wire hot cathode and a tungsten plate cold anode, the bulb being filled with rarefied argon. With the usual affection for special names this particular modification of the Fleming valve has been called a Tungar Rectifier.¹

The bulb of the valve is first highly exhausted and then refilled with argon under a pressure of 30 to 80 mm. of

¹ See *The General Electric Review*, vol. xix., p. 297, April, 1916, article by Mr. G. Stanley Meikle on "The Hot Cathode Argon Gas-filled Rectifier"; also *ibid.*, vol. xx., p. 209, Mr. R. E. Russell on "The Tungar Rectifier."

RADIOTELEGRAPHY AND TELEPHONY

mercury. The hot cathode is a tungsten wire spiral and this is placed very close to the cold anode tungsten plate. These valves are meant to operate on low voltage (75-120 volts) alternating current circuits and to rectify the alternating current for various purposes, such as battery charging, bell ringing or telegraph work. The valves are made in three sizes—viz., to rectify 2 amperes at 115 volts, 6 amperes at 7-15 volts, and 6 amperes at 7-75 volts. The appearance of the 6-ampere tungar is shown in Fig. 45.

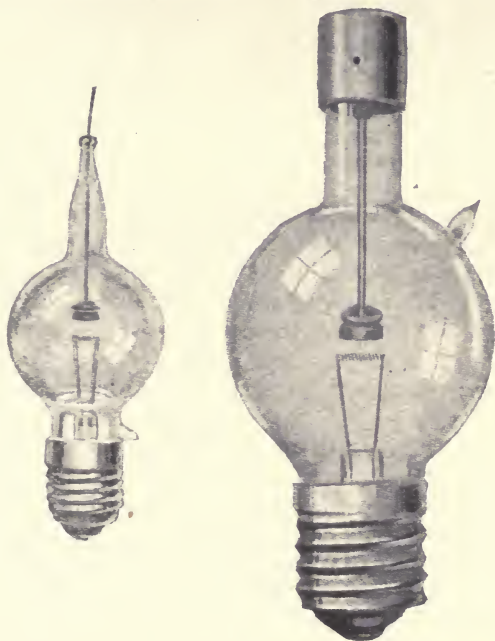

FIG. 45.—Two-ampere and Six-ampere Tungars or Low Vacuum Argon-filled Oscillation Rectifying Valves.

When used for rectifying an alternating current the tungsten filament or cathode is rendered incandescent by an alternating current supplied at proper voltage through a small transformer, *T*, operated from the alternating current supply. There is then a separate circuit formed by connecting to the terminals of the alternating circuit the cold tungsten anode, *A*, on one side and the hot cathode, *F*, on the other, and in this circuit is inserted the battery or other

appliance to be served or worked by the rectified alternating current. The valve permits the passage of negative electricity only from the hot cathode to the cold anode (see Fig. 46).

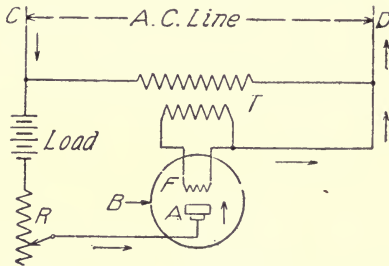

FIG. 46.—Scheme of Connections for using Tungsar Rectifying Valve to Rectify a Low-frequency Alternating Current.

All kinds of modifications of the original invention have been suggested or patented, such as the use of a pool of mercury in the bulb as an anode (see United States patent of Lee de Forest, No. 837,901, application of February 14th, 1906) and the division of the anode plate into two

parts. In none of these, however, is there any departure from the essential principle that the emission of electrons or negative ions from an incandescent body supplies the means of making a space between it and a cold metal anode unilateral in conductivity and therefore capable of rectifying an electric oscillation.

No doubt, many of these suggested modifications have been prompted by the desire to evade the claims of the specification in which the author defined his invention. A patentee is bound properly to "ascertain his invention" and state the best means he knows of carrying it into effect, but if his invention or application is of a very novel kind he is entitled to a broad interpretation of his instructions. His patent rights are not avoided merely by carrying out to a greater or lesser degree the instructions in his specification. If, for instance, as in this case, he says a bulb is to be exhausted or to be vacuous, then that means vacuum enough to cause the required effect to be produced. If there is some degree of vacuum below or above which the effect does not take place then the patentee would be bound to define it precisely. On the other hand, if the effect is manifested over a large range then subsequent employers of the instrument or means will not evade the claims of the original patent merely because they follow out to the highest degree or else less perfectly the instructions in the specification. There is in the case of the Fleming oscillation valve

no justification for drawing a hard and sharp line between high vacuum, low vacuum, and moderate vacuum valves or limiting the author's invention to one of these grades. All that can be said is that in the case of vacua not very high gas ionisation phenomena make their appearance and make conditions, irregularities or complications which may or may not render that particular instrument useful, but are not easy to reproduce identically in other samples. The pivot of the whole matter is, however, the application of thermionic emission from a heated filament or body to the construction of a "valve" or non-symmetrical conductor of electricity for rectifying high-frequency electric currents as used in radiotelegraphy.

8. A matter of practical utility is the testing of thermionic detectors so as to classify them or recognise the effect of various modes of manufacture. It is not always possible or convenient to do this by actual tests made at a wireless station. Hence, at an early stage, the author found it desirable to arrange methods for doing this which could be carried out in a laboratory within moderate distances. The following appliances have been found useful. It makes use of electric oscillations created by ordinary electromagnetic induction and not by true electric space waves. At some convenient place a closed electric circuit is set up consisting of a coil of wire, preferably consisting of insulated copper wire, forming a few turns round a square frame, L_1 , as in Fig. 47. Such a frame is easily made by crossing two strips of wood about 6 or 8 ft. long and 3 in. wide by $\frac{3}{4}$ in. thick, so as to form an equal-armed cross. Round this may be wound 8 or 10 turns of stranded insulated copper wire, say 7/20 or 7/22 in size. This circuit is placed in series with a condenser, C , consisting of one or more Leyden jars and with a spark discharger, S . The discharger should be included in a sound-proof iron box and a jet of air should be projected on the spark gap. Without this precaution steady oscillations cannot be obtained. To obtain the best results, however, the discharger should be a quenched spark discharger, preferably the rotating flat steel disks in oil as constructed by the author.¹

¹ See J. A. Fleming, *The Principles of Electric Wave Telegraphy and Telephony*, chap vii., 3rd Edition, p. 690; also J. A. Fleming, British Patent Specification No. 23,242 of 1910.

THE THERMIONIC VALVE IN

In this latter case the primary circuit in which the spark gap is placed must be in contiguity to another closed oscillation circuit comprising a similar and equal coil of wire and condenser tuned to the spark gap circuit.

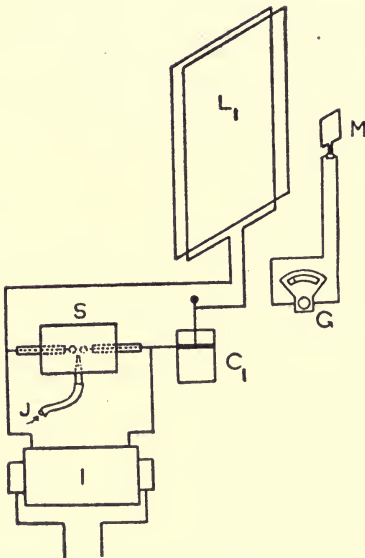

FIG. 47.—SCHEME OF CONNECTIONS OF PRIMARY OSCILLATION CIRCUIT IN THE AUTHOR'S VALVE - TESTING ARRANGEMENT.

I, Induction Coil. S, Spark Gap with Air Blast. C, Condenser. L, Primary Circuit.

The quenched discharges in the latter circuit will then give rise to trains of feebly damped oscillations in the adjacent circuit of great uniformity. The mean square value of the current in this oscillatory circuit can be determined by a hot-wire or thermoelectric ammeter inserted in it, or in a circuit *M* inductively coupled to it, and it will be found that if the above arrangements are adopted, the mean square value of the discharge current in the oscillatory circuit can be kept extremely constant for hours together. Signals can also be automatically sent by interrupting the primary circuit of the transformer or induction coil by a key operated by a punched tape. In this manner a succession of Morse signals may be sent, or long and short signals of any kind, for the purpose of testing the transmission of any particular words or letters. If the spark chamber is made of thick cast-iron the apparatus will be nearly noiseless, and may therefore be set up in a laboratory without disturbing other workers, which is not the case when an open oscillatory spark is employed. At a distance, say, of 50 to 150 ft. or more another square circuit may be set up consisting of a similar square coil of insulated wire L_2 (see Fig. 48) and a condenser C_2 , which is preferably a condenser of variable capacity for

tuning purposes. A convenient form is one consisting of fixed semicircular plates and a number of movable semicircular plates fixed on a shaft, which can be rotated, so as to bring the second set of plates more or less in between the first set, the vessel being filled with a highly insulating oil. Two of such closed oscillatory circuits can be set up at a distance, say, of 50, 100 or 200 ft. within a large building, and even the interposition of brick walls makes no difference, provided they do not contain metal girders.

To test, then, a radiotelegraphic detector of any kind it is necessary to be certain that the detector *per se*, when unconnected to the oscillatory receiving circuit, is not directly affected by the spark at the distance at which the sending and receiving circuits are set up; but this can easily be done, and then

any particular type of oscillation detector, *D* (see Fig. 48), whether of the current actuated type or the potential actuated type, can be tested as to sensibility by inserting it either in series with the condenser of the receiving circuit or in parallel with the condenser of the receiving circuit. The detector *D* is associated with a telephone *T* and a battery *B* shunted by resistance *R* as usual. The use of the closed circuits has this great advantage, that

being directive radiators and absorbers it is possible, by a displacement of the planes of the magnetic oscillators with reference to one another, to obtain a quantitative measure of the sensibility of any given oscillation detector. Thus, for instance, it is generally possible, but not always, to find a position for the closed circuit of the receiver, such that at a certain distance no effect can be detected in that receiving circuit by any oscillation detector, however

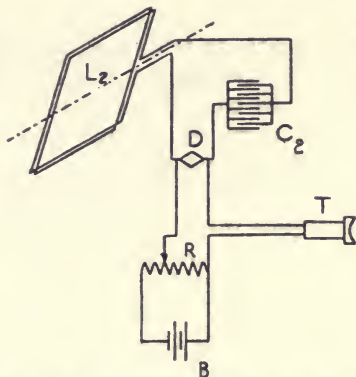

FIG. 48.—ARRANGEMENT OF RECEIVING CIRCUIT FOR TESTING RELATIVE SENSIBILITY OF DETECTORS USED IN WIRELESS TELEGRAPHY.

*L*₂ is the Receiving Coil. *D*, the Detector. *T*, a Telephone Receiver.

sensitive. We may then call this the zero position. If the receiving circuit is moved out of the zero position by turning it through a certain angle round any axis it will begin to be affected by the distant transmitting circuit, and a quantitative measure of any oscillation detector can be obtained by noting the angle through which the receiving circuit must be turned, so that good audible signals may just be obtained. Whether the action of the sending on the receiving circuit is due to true electromagnetic radiation or to ordinary electromagnetic induction seems immaterial. The result in either case is that the receiving circuit is the seat of feeble electrical oscillations and the oscillation detector has to detect these if it can.

Another method is to maintain the receiving circuit in its position of maximum effect, but to upset the tuning of the receiving circuit by varying the capacity of the condenser or the inductance of the circuit. This varies the mean square value of the received current and from the resonance curve enables us to get the measure of the current or potential difference which the particular oscillation detector under test will just not detect.

It has been found convenient to denote the relative telegraphic value of detectors by stating the angle in degrees through which the receiving coil has to be rotated from the zero position that good audible signals can be obtained on the telephone. If a note is made of the value in amperes or milliamperes of the current in the closed transmitting circuit, this can always be recovered, and if the spark length and spark frequency are the same, we can always be sure that the sending circuit is in a constant and similar condition when comparative tests are made.

The closed receiving coil is conveniently made by winding silk-covered copper wire, No. 16 S.W.G., on a square mahogany frame, which can be revolved on pivots carried on a baseboard which can itself be set at any required angle (see Fig. 49). A divided circle and pointer attached to the frame serve to show the angle through which the frame is rotated. In general appearance it resembles an instrument used in physical laboratories under the name of an earth inductor, for obtaining small induced currents by means of the rotation of a coil in the terrestrial magnetic field.

If a closed transmitting circuit is set up at a distance, then

it is generally possible to find a position for the receiving coil such that it will not detect any signals when coupled with a condenser and tuned and associated with a highly sensitive receiver. On turning the coil through a certain angle the signals will be heard. If a very sensitive oscillation detector is employed, then there may be no position of absolutely null reception, but there will be a position of minimum reception. Thus, for instance, in a certain case, with a coil used at the Pender Electrical Laboratory, some Fleming oscillation valves of a new type were found to be so sensitive to oscillations that no position in which the receiving

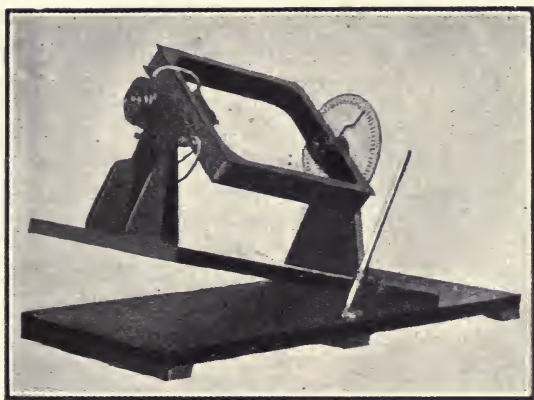

FIG. 49.—Photograph showing details of construction of the Tilting Receiving Coil, L_2 .

circuit could be placed was so completely a position of zero mutual induction that these valves, when used with a telephone, gave no signals from a tuned transmitter. Such valves were called zero valves. Others, on the contrary, could not detect signals until the coil had been turned through 5° , 10° or 20° from the zero or minimum position. A magnetic detector inserted in series with the coil could not detect the signals from the transmitter until the coil was turned through 15° . An electrolytic detector of a particular make required a rotation of 40° , and a carborundum detector required 45° rotation of the coil to give audible signals on the telephone. These measurements are not given as absolute and final measurements of the relative sensibility of all magnetic, electrolytic or crystal detectors, but merely as examples of the ease with which the sensibility of these

special samples of receivers could be tested for order of sensibility. The instrument has proved of great use in connection with improvements in thermionic detectors.¹

9. This chapter may be concluded with a few notes on the making of high vacua, especially with reference to the manufacture of oscillation valves. In all this work the great difficulty and desideratum is to remove the adherent films of air and occluded air or gases from the inside of the bulb and the objects which are sealed therein. The mere exhaustion of the bulb by some form of mercury pump is quite insufficient, when taken alone, to produce the vacuum which will stay constant when the cathode or filament is heated. For this purpose prolonged heating of the bulb and its contents to a temperature of 500° or, better, 700° C. is necessary. If this temperature is sufficient to soften the glass and collapse the bulb under the external atmospheric pressure, then the bulb must be enclosed in a vacuum furnace, in which the requisite temperature is produced by electric-resistance heating. Such a furnace may be constructed with a cast-iron cylinder closed at the bottom and flanged at the top, with a cast-iron lid planed on one side to fit airtight, with a red-lead joint on the cylinder flange. This cylinder should be lined with a silica or alundum tube. In the interior must be fixed heating spirals or loops or nichrome wire, the ends of this wire being brought out airtight through red-lead and asbestos-packed glands in the lid. The lid has also a gland through which passes, airtight, the glass tube leading to the bulb to be exhausted. The cylinder should be well lagged with heat-insulating material, such as slag wool. By passing a suitable electric current through the nichrome wire it can be raised to a red heat and will soon bring any object in the cylinder to 700° C. This furnace is kept exhausted by some form of rapid mechanical vacuum pump, such as a "Geryk" pump, made by the Pulsometer Engineering Company of Reading, England. This vacuum need not be very high. It is simply intended to remove the greater part of the air pressure from the outside of the heated glass bulb.

¹ See J. A. Fleming and G. B. Dyke, "A Note on the Production of Steady Oscillations in Closed Circuits and on Methods of Testing Radiotelegraphic Receivers," *Phil. Mag.*, May, 1909; also *Proc. Phys. Soc. Lond.*, vol. xxi., p. 657.

RADIOTELEGRAPHY AND TELEPHONY

The exhaustion of the bulb must be conducted in two stages. The removal of the chief part of the air from the bulb can be rapidly conducted by a high vacuum mechanical pump, such as is made by the Pulsometer Engineering Company. This will reduce the pressure to about 0.001 mm. The remaining exhaustion can be conducted by some form of rotary mechanical pump, such as a "Box" pump or by a Gaede pump. This latter pump is not a piston or valve pump, and will remove vapours as well as

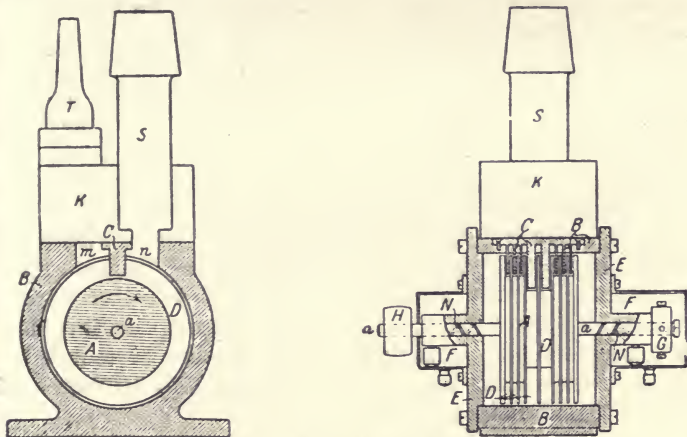

FIG. 50.—Sections of a Gaede Molecular Pump.

gases. As it is a German invention and not obtainable in Allied countries since the war, a few notes on its construction are given here. The reader may be referred for fuller information to the description of it by its inventor, W. Gaede, in the *Annalen der Physik*, vol. xli., p. 337, 1913, or to his United States Patent, No. 1,069,408, August 5th, 1913.

The principle of the pump can be understood from the diagram in Fig. 50. A cylindrical mass of metal, *A*, revolves in a closed chamber, the axle passing airtight through bearings. Let a small partition project from the casing and nearly touch the cylinder. Then, if the latter revolves quickly, it will carry air with it, owing to the viscosity of the air and the adhesion of the air to the cylinder and to adjacent layers of air. Hence, if two openings, *m* and *n*, are made, one either side of the partition leading to two chambers, the air in one will be slightly rarefied and in the other

slightly compressed. Then let another such pump be joined to the first, so that the exhaust side of one pump is connected to the compression side of the other, and we shall add the pressure difference. By forming a number of grooves in a metal barrel and letting projections from the fixed casing descend into these grooves and cross-connecting the spaces of reduced and increased pressure for such element, we construct what is, in fact, a chain or cascade of pumps, each making a slight decrease, step by step, in the pressure gradient. In this manner we can reduce the air pressure in a vessel indefinitely if connected to the last or least pressure channel in the above pump. Instead of stepping down from atmospheric pressure it is more convenient to use a good piston pump to evacuate the bulk of the air, and then reduce by the Gaede pump the pressure to the required limit.

It is necessary to insert between the object to be exhausted and the Gaede pump a liquid-air trap to condense all vapours. Also drying tubes of phosphoric pentoxide must be inserted in the circuit to prevent any water vapour finding its way back. By long-continued heating and pumping with the Gaede pump it is possible to reduce the air pressure in the bulb to be exhausted to 10^{-6} or even 10^{-8} of a millimetre of mercury.

There is, however, always some uncertainty about these measurements of small air pressure. The only thing a vacuum gauge of any kind can measure is the pressure in itself at the moment of reading. The flow of air along tubes of glass connecting the pump and the bulb to be exhausted and the vacuum gauge is very slow at reduced pressures, and what is required is a low pressure in the vessel being exhausted and not merely a low pressure in the gauge.

The McLeod low-pressure gauge is very commonly employed for this purpose. It consists of a glass bulb, *B* (see Fig. 51), which terminates in a narrow tube, *D*, closed at the top. The bottom of the bulb has a tube attached to it with a flexible tube leading to a mercury reservoir, *R*, which can be raised or lowered. Just below the bulb a side tube, *S*, branches off and passes up above the bulb leading to the vessel to be exhausted. When the mercury reservoir is raised the mercury rises and cuts off

connection with the side branch and finally compresses all the rarefied air in the bulb, *B*, up into the narrow tube, *D*. The instrument maker furnishes the ratio of volume of the bulb to that of 1 cm. or 1 mm. of length of the closed tube leading from the top. When the volume of rarefied air in the bulb is compressed its pressure is thereby increased inversely as the reduction in volume. At the same time the mercury rises in the side tube which is in connection with the vessel being exhausted. Hence, we can see at a glance the difference in level of the mercury in the side tube and in the tube into which the air in the bulb has been compressed. Since we can observe the reduction in

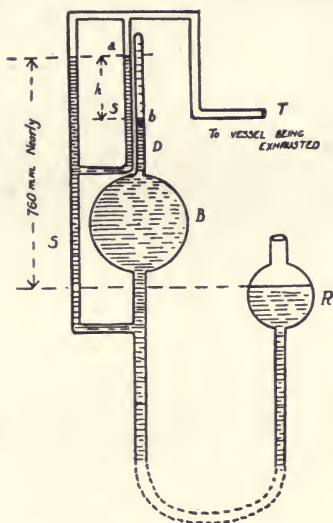

FIG. 51.—The McLeod Pressure Gauge.

volume of this air we know its increase in pressure. Suppose, for instance, that the residual air in the bulb is reduced to $\frac{1}{10000}$ part of its original volume, and that the difference in its resulting pressure and that in the side tube is 20 mm. Then the air in the vessel being exhausted has been reduced to $\frac{1}{10000}$ of 20 mm., or to 0.002 mm. pressure.

Dr. Langmuir has designed a very ingenious low-pressure gauge depending upon the reduction of gas viscosity when the pressure is reduced below a certain limiting value (see *Physical Review*, April, 1913, p. 337; see also United States Patent Specification, No. 1,126,233, of March 8th, 1913). Inside a glass vessel is pivoted a thin aluminium disk fixed on a steel or tungsten shaft. The disk has a magnet fixed to it. The vessel is placed in the interior of a closed iron ring wound with coils like a Gramme ring (see Fig. 52). This ring is supplied with current at six points and by a commutator rotated by a motor the current is supplied to the coils in succession, so as to create in the interior of the ring a

THE THERMIONIC VALVE IN

rotating magnetic field. The aluminium disk is thereby caused to rotate rapidly. Above this disk is suspended by a quartz fibre a mica disk, and the viscosity of the air causes the rotating aluminium disk to carry the mica disk along with it as far as the elasticity of the fibre allows. This mica disk has a mirror attached to it, so that by the displacement of a ray of light reflected from the mirror we can measure the angular displacement of the mica disk. When the air pressure is much reduced, say below 0.01 mm., the drag on the mica disk begins to be reduced, and below

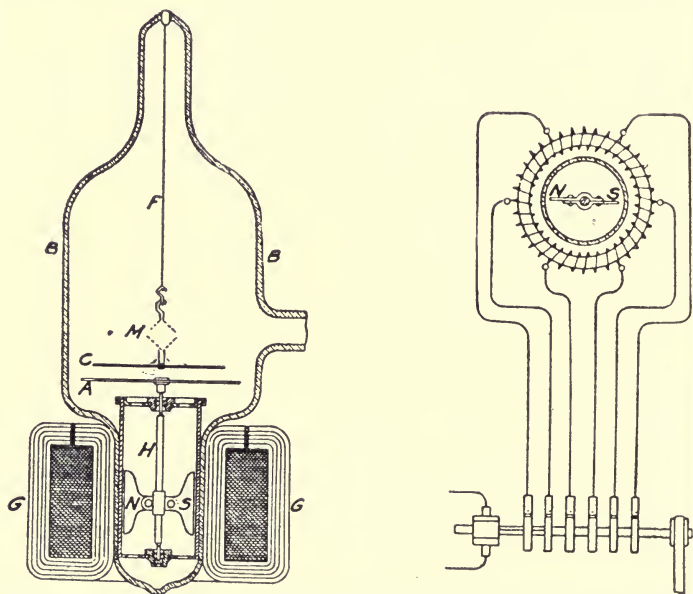

FIG. 52.—Irving Langmuir High-Vacuum Pressure Gauge, depending upon reduction in gas viscosity.

that pressure the drag falls off almost proportionately with the pressure. Hence the arrangement can be graduated as a low-pressure gauge by noting the angular displacement of the mica disk when the aluminium disk is rotating at a known constant high speed, say, 10,000 R.P.M. A form of gauge for measuring vacua below 10^{-3} m.m. of mercury, called an "ionisation manometer," has been proposed by O. E. Buckley. The vacuum is measured by the number

of positive ions produced by the thermionic emission from an incandescent filament in a fixed time.

In a recent paper on the production and measurement of high vacua (see *Physical Review*, July, 1918) J. E. Shrader and R. G. Sherwood, of the Westinghouse Research Laboratory, U.S.A., describe a form of absolute manometer which was more fully described by Professor Martin Knudsen, of Copenhagen, in 1910 (see *Annalen der Physik*, vol. xxxii, p. 809, 1910).

This gauge consists of a strip of platinum or tungsten which can be heated by an electric current. In front of this strip and about 1 mm. from it is suspended by a torsion wire a flat strip of metal foil, having a mirror attached to it. When the strip of platinum is heated it repels the suspended foil by radiometer action and this repulsion can be measured in absolute units by simple and known means. The repulsion depends upon the gas pressure and upon the absolute temperatures T_1 and T_2 of the strip and the foil.

If P is the gas pressure in dynes per sq. cm. and K is the repulsion in dynes, then Knudsen showed that

$$P = \frac{2K}{\sqrt{\frac{T_1}{T_2} - 1}}$$

This formula does not hold good for pressures above 0.003 mm. of mercury, but it enables an absolute manometer to be constructed for low pressures. For details the reader is referred to an article in *Engineering* for December 13th, 1918, p. 686.

No reference to the subject of high vacua would be satisfactory without at least a mention of the beautiful process invented by Sir James Dewar for creating a high vacuum by the aid of charcoal cooled in liquid air.

It has been known for a long period of time that charcoal has unique power of absorbing gases and vapours. Professors Tait and Dewar in 1874-5 were the first to recognise and take advantage of this property to make a vacuum by heating charcoal and then allowing it to absorb the residual gas in a bulb.¹ Crushed charcoal presents an enormous surface for absorption. A cubic inch of charcoal cut into

¹ See a paper by these authors in the *Proceedings of the Royal Society of Edinburgh*, 1875, vol. viii., p. 348; also *Nature*, 1875, vol. xii., p. 217 "On a New Method of Obtaining very Perfect Vacua."

THE THERMIONIC VALVE IN

small cubes with edges $\frac{1}{2400}$ of an in. in size would offer a surface of about 73 ft. for absorption.

In the course of his investigations on liquid air Sir James Dewar discovered that this absorptive power of charcoal for gases is enormously increased if the charcoal is cooled in liquid air. The most effective charcoal for this purpose is that made by carbonising fragments of cocoanut shell, which is heated in a closed vessel, at first slowly and then to gradually increasing temperatures. At the temperature of liquid air ($= -185^{\circ}\text{C}.$) such carbon absorbs 10 to 12 times the volume of nitrogen or oxygen that it will do at normal temperature. One gramme of cocoanut charcoal prepared as above will absorb at $-185^{\circ}\text{C}.$ about 350 to 400 cubic centimetres of air.

The process therefore of making a high vacuum by this charcoal method is as follows: Cocoanut charcoal is crushed into granules about the size of small shot, and a certain bulk of this, depending on the size of the vessel to be exhausted, is sealed up in a glass bulb, which is connected by a T-joint with the vessel to be exhausted and with a mechanical pump which will make a vacuum of at least 0.001 mm. During this first exhaustion the vessel to be exhausted and all its contents should be heated to a high temperature and the charcoal also heated. This being done the side tube leading to the pump is sealed off, but leaving the charcoal bulb in connection with the nearly exhausted vessel. When all is cool the charcoal bulb is immersed in liquid air and left there for about an hour. The cooled charcoal will remove the residual gases and greatly increase the vacuum.

The arrangements necessary for this exhaustion are shown in Fig. 53, which is taken with slight modification from Sir James Dewar's British Patent Specification, No. 13,638, of June 16th, 1904, for this invention.¹

Sir James Dewar has applied this process also to the separation of the rarer constituents of the air—viz., neon, helium, krypton, etc.—from the more abundant oxygen and nitrogen. Charcoal exercises a selective absorption, and when normal air is passed over charcoal cooled to

¹ This British patent, which would in ordinary course have expired in 1918, has recently been granted extension for five years. The United States equivalent patents are No. 815,942, dated March 27th, 1906, and No. 879,129, dated February 11th, 1908.

-185° C. the portions not absorbed are richer in these rarer gases because they are less absorbed than oxygen and nitrogen. Hence, by repeating the process, the neon, helium and krypton may be obtained in a concentrated form and free from excessive dilution by oxygen and nitrogen.

Whenever a liquid air plant is available this charcoal vacuum process is much the most convenient way of obtaining a very high vacuum. Using a tube containing only 1 gram of charcoal connected to a vessel of 300 c.c.

capacity and making a preliminary vacuum of 1 to 2 mm. in the vessel and then cooling the charcoal to -185° C. the pressure in the vessel was reduced to 0.00005 mm. in one hour.¹

A high vacuum mercury pump has been invented by Dr. Irving Langmuir which operates on the principle of the steam injector.² If a stream of gas or liquid issues from a jet the air in its neighbourhood partakes of its motion to some extent, and in accordance with the principle that where velocity is greatest pressure is least the air pressure in the vicinity of the jet is reduced. This has been applied in the construction of a vacuum pump as follows:

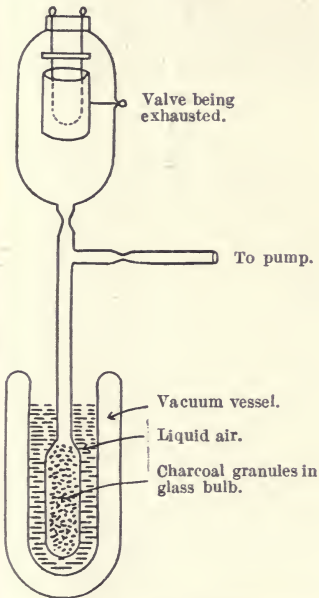

FIG. 53.—Sir James Dewar's method of making a High Vacuum by the Absorption effected by Charcoal cooled in Liquid Air.

A vessel of glass or iron, *A* (see Fig. 54), contains mercury, which is made to boil by a source of heat. The mercury vapour rushes up the tube, *B*, and issues from a jet, *P*, which is placed just

¹ See Prof. H. E. Armstrong, "Low Temperature Research at the Royal Institution, 1900-1907," *Proc. Royal Institution*, vol. xix., Part I., p. 362, 1911, Hodgkin's Trust Essay.

² See Irving Langmuir, "On a High Vacuum Mercury Pump of Extreme Speed," *Physical Review*, 1916, vol. viii., Series II., p. 48.

THE THERMIONIC VALVE IN

within another tube, *H*, having an enlargement like a paraffin lamp chimney. Around the tube, *B*, there is a second enclosure, *E*, which communicates by a tube, *F*, with a trap, *G*, and with the vessel, *V*, to be exhausted. The tube, *H*, with bulbous enlargement, is surrounded by a water jacket, *J*, to keep it cool, and the tube, *C*, terminates in a pear-shaped condenser, *D*, which is in communication by a tube, *N*, with some form of mechanical pump, making a low vacuum.

The mercury in *A* therefore boils under reduced pressure. When the mercury vapour rushes out of the jet, *P*, it sucks air from the space, *E*, and carries it up into the condenser, *D*, where it is removed by the mechanical pump. The mercury vapour condenses in *H* and *D* and falls back into the boiler *A*. Hence, there is a continual aspiration of air from the space, *E*, and from the vessel, *V*, being exhausted. If a good mechanical pump is employed to keep a fairly good vacuum of about $\cdot 001$ or $\cdot 002$ mm. in the mercury pump the latter will soon produce a very high vacuum in the vessel to be exhausted. The whole of the mercury pump is best made of iron, the parts being made to screw together. The General Electric Company of America have made a number of these pumps, and they are in extensive use at various factories for lamp and valve exhaustion.

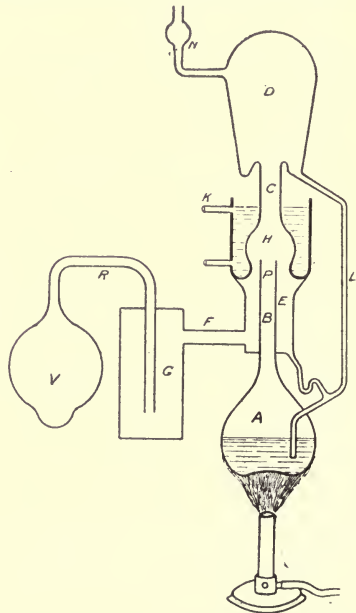

FIG. 54.—Irving Langmuir High-Vacuum Boiling Mercury Pump.

Various modifications of this boiling mercury pump are in use in lamp factories for valve manufacture.

The Cosmos Lamp Works, Ltd., of Ponders End, Middlesex, England, make a simple form of mercury pump of steel. It consists of a steel flask, *F*, of thin welded sheet steel, which

has an exit pipe at the top and a side tube, *N*, entering it about one-third of the way up (see Fig. 55). The top tube is connected to a mechanical pump making a vacuum of about 0.002 mm., but between the mechanical pump and the

To valve being exhausted.

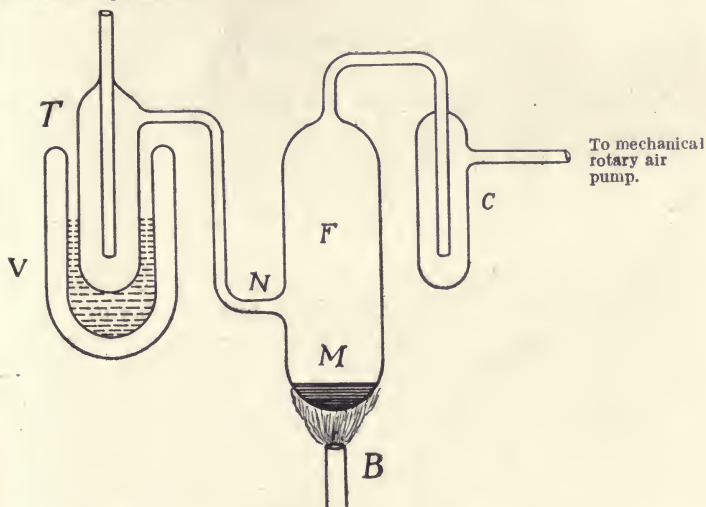

FIG. 55.—Cosmos High-Vacuum Boiling Mercury Pump.

mercury pump must be inserted some trap, *C*, for stopping the passage of mercury vapour. This may consist of a long tube kept cold and filled with copper turnings.

The steel flask has about 1 lb. of mercury put in it, and this is caused to boil by a lamp, *B*. The mercury boiling under reduced pressure rises in the form of mercury vapour and carries with it air molecules entering by the side tube from the vessel to be exhausted. The mercury vapour condenses in the cold upper part of the flask and falls back again. Hence, there is no loss of mercury. Between the side tube and the vessel to be exhausted a trap vessel, *T*, placed in liquid air, *V*, must be inserted to prevent any diffusion of mercury vapour into the vessel being exhausted. The connections are shown in Fig. 55.

CHAPTER III.

THE THREE-ELECTRODE VALVE.

1. An improvement on the hot and single cold electrode oscillation valve described in the previous chapter was effected by the introduction of a second cold electrode in the form of a grid, wire zig-zag or perforated plate placed in between the hot cathode and cold electrode of the Fleming valve.

This modification enabled the appliance to be used not merely to rectify electric oscillations, but to relay or repeat them on a magnified scale, so that when employed with a telephone, as below described, a considerable increase in oscillation-detecting power ensued. Also it made it possible to use the instrument as a telegraphic relay of a certain kind. The credit for this structural improvement must be given to Dr. Lee de Forest, who arrived at it by a series of steps presently to be mentioned.

Underrating, however, the author's previous work in the invention of the two-electrode valve, he took the view that his improvement constituted a new invention originating entirely with himself, independent of everything that had been done before, and radically different in operation from the Fleming valve.

Hence he availed himself of many opportunities for disparaging the author's prior work, incorrectly representing the two-electrode oscillation valve as a comparatively useless laboratory device appropriated from Mr. Edison, or else "taken from the early German scientists by Professor Fleming."¹

¹ See letter of L. de Forest in *The Electrician*, vol. lxi., p. 804, September 4th, 1908. A prolonged controversy took place on this subject. See de Forest's letters in *The Electrician*, vol. lviii., p. 425, December 28th, 1906; vol. lxi., p. 804, September 4th, 1908; vol. lxi., p. 1006, October 9th, 1908; and vol. lxxii., p. 659, January 23rd, 1914. Also the author's replies in *The Electrician*, vol. lviii., p. 263, November 30th, 1906; vol. lviii., p. 464, January 4th, 1907; vol. lxi., p. 843, September 11th, 1908; vol. lxxii., p. 377, December 5th, 1913; vol. lxxii., p. 660, January 23rd, 1914.

The judgment of Judge Mayer and the confirmatory unanimous judgment of the Court of Appeals in the action-at-law already mentioned in Chapter II. have cleared away these misconceptions and shown that his improvements are of the nature of modifications of the original invention of the oscillation valve, but involve the same physical principles, and cannot be exercised in the United States of America in commercial manufacture without infringing certain claims in the author's fundamental valve patent as long as it remains in force.

The stages by which de Forest reached this modification, or improvement, were as follows: In or before 1904 he was engaged in researches on the production of some new detector devices he called "oscillation responsive devices," in which two electrodes were immersed in the flame of a Bunsen burner and connected respectively to the earth and to a receiving aerial. They were also joined by a circuit containing a battery and a telephone. The idea seems to have been that the oscillations in the aerial would put the "gaseous medium"—*i.e.*, the flame, "into a condition of molecular activity," and that it would then become a conductor and pass the current from the battery through the telephone in series with it and thus produce a sound.

He applied, on February 2nd, 1905, for a United States patent for these devices, the specification having been actually signed by him on November 4th, 1904, a few days before the application of the author for the British valve patent, No. 24,850, of 1904, and some weeks before the application for the corresponding United States patent, No. 803,684.

In this specification, No. 979,275, of 1905, Lee de Forest included amongst his Bunsen burner oscillation responsive devices one consisting of a bulb filled with air or gas, in which were two electrodes intended to be heated by a dynamo, but as the electrodes are shown in the diagram connected by a telephone, it is not at all clear how they could carry a heating current from the dynamo (see p. 106, Fig. 56a). The specification contains forty-one claims and abounds in such vague phrases as "a sensitive constantly receptive oscillation responsive device comprising in its construction a sensitive conducting gaseous medium." The

various items in this United States patent of de Forest, No. 979,275, were subsequently divided into separate applications and formed the subject-matter of three subsidiary specifications—viz., No. 867,876, application of April 4th, 1906; No. 867,877, application of June 12th, 1907; No. 867,878, application of June 12th, 1907.

It is not at all certain that any of these devices were ever put into practical operation, but, nevertheless, their patentee referred to this United States patent, No. 979,275, some ten years afterwards as his "basic American patent."¹

When, however, in 1916, the question of its real value came to be discussed impartially in a Court of Law, Judge Mayer, who tried the case, in giving judgment on September 20th, 1916, in the action brought by the Marconi Wireless Telegraph Company of America against de Forest Radio Telephone and Telegraph Company, after a prolonged legal contest on the Fleming and de Forest patents, said: "This burner detector of de Forest has never been commercially used and thus has not made any impression on the art. A mere inspection of the device in operation will show that this flickering flame is impracticable. The most that can be said for it is that it may contain the germ of an idea which in this rapidly-progressing art may hereafter be utilised in some way. Whilst, therefore, it is not necessary to declare this patent and its three subsidiaries invalid, it may be eliminated from this case for all practical purposes."

Soon after the date of application for the Bunsen burner patent de Forest had brought to his notice the paper published by the author in the *Proceedings of the Royal Society of London* issue of March 16th, 1905, which had been read to the Society on February 9th of that year entitled, "On the Conversion of Electric Oscillations into Continuous Currents by means of a Vacuum Valve."

It is clear from subsequent events that this paper was the means of starting trains of thought in his mind which had certainly not been there before its perusal. He must then have become strongly impressed with the idea that what was required was not "a gaseous medium in a state of molecular activity," but some means of rectifying, as the

¹ See a letter by Dr. Lee de Forest to *The Electrician* (London), on January 23rd, 1914, vol. lxxii., p. 659; and reply by J. A. Fleming, *ibid.*, p. 660.

author had shown, the trains of electric oscillations into unidirectional currents to make them affect a telephone or other instrument. Accordingly, in his next U.S. patent application, No. 823,402, filed December 9th, 1905, covering inventions in radiotelegraphy, we find he made use of the Fleming valve, and gave also a reference to its published description in the *Proceedings of the Royal Society*, March 16th, 1905.

Very ingeniously, however, he couples with this valve, and as equivalent to it, one of his Bunsen burner detectors, the flame of which is rendered more conducting by sodium or other salts, and this flame is now described as having a non-symmetrical conductivity. He states that positive electricity passes more readily in one direction in the flame than in the opposite.

The Bunsen burner had thus been transmitted into a rectifier of oscillations, and is described as a "valve" in this de Forest specification. His next step was to apply, on January 18th, 1906, for a United States patent, No. 824,637, for an oscillation-responsive device "of great simplicity and sensitiveness." In this specification great cleverness is shown in the treatment by which the oscillation responsive device, shown in his Bunsen burner patent, No. 979,275 (Fig. 6) and its subsidiary or divided application, No. 867,876, of April 4th, 1906, is gradually transformed into an identity with the author's oscillation valve, but disguised by the use of pseudo-scientific language, so as to appear to be something quite novel.

The glass bulb is described as a "receptacle," and the more or less perfect vacuum is a "gaseous medium," which is to be put into a condition of "molecular activity," "highly sensitive to electrical oscillations," when an electric current is employed "to heat two highly-resistant electrodes."

Diagrams are then given in this specification in which there is, as it were, a slow evolutionary transformation from the sterile oscillation-responsive device of specification No. 979,275 (Fig. 6) to a nearly complete identity with the author's previously described valve detector. The diagrams *a, b, c, d*, in Fig. 56 are taken from de Forest's U.S. specifications, and show how ingeniously this metamorphosis was managed. The series, in fact, reminds us forcibly of the

THE THERMIONIC VALVE IN

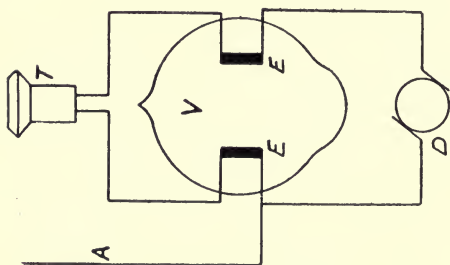

FIG. 56 (A).
Fig. 6, U.S. Patent
No. 979,275
Nov. 4th, 1904

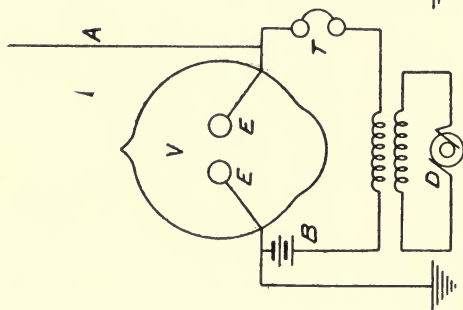

FIG. 56 (R).
Fig. 5, U.S. Patent
No. 824,637
Jan. 18th, 1906

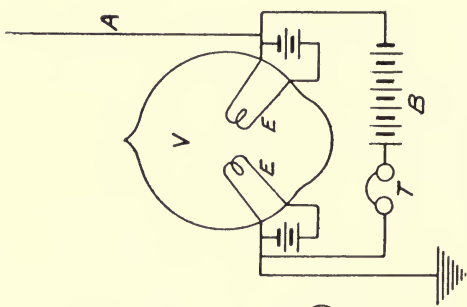

FIG. 56 (C)
Fig. 1, U.S. Patent
No. 824,637
Jan. 18th, 1906.

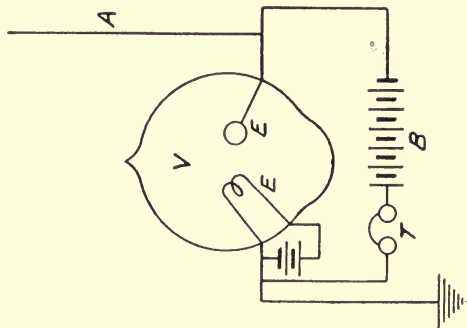

FIG. 56 (D).
Fig. 3, U.S. Patent
No. 824,637
Jan. 18th, 1906.

FIG. 56.—Diagrams taken from U.S. Patent Specifications of Lee de Forest.

illustrations in books on geology, showing the gradual evolution of present-day forms of animal life from ancient prehistoric types now extinct.

In the above specification it was stated that heating the electrodes is not even necessary, and that the gas may be "rendered sensitive to electrical oscillations by heating or by any other suitable means." As an example of such "suitable means" it is sufficient to cover the electrodes with "some radio-active substance such as radium bromid."

The next step was to sub-divide this broad specification into others covering its separate parts—viz., No. 836,070 (application of May 19th, 1906), and No. 836,071 (application of May 19th 1906). The first of these includes and describes identically the same article as a Fleming valve. The "receptacle" is now "partially exhausted." Two electrodes are sealed into it. One electrode, *E*, may be an "ordinary incandescent lamp carbon filament," the other "a disk of platinum or other material." The "gaseous medium" between them is rendered sensitive to electrical oscillations by the radiation of heat from the electrode, *E*, the said electrode being heated by a source of energy.

Influenced by this verbal camouflage, the United States Patent Office examiners could hardly help believing that the above specification described something entirely new and different from the simple Fleming valve for which a United States patent had been applied and issued months before, the only difference being that in the former specification the valve is shown associated with a telephone and boosting battery as signal detector, and in the latter with a galvanometer or other current-detecting instrument.

In order to maintain the tradition that the Bunsen burner detector was the real parent of all subsequent forms of valve, Dr. Lee de Forest continued his course on January 20th, 1906, by filing an application, No. 824,638, for another Bunsen burner patent. In this case electrodes are placed in a Bunsen flame. "These may consist of platinum or carbon, or one may be of platinum and the other of carbon." "When electrical oscillations are developed in the antenna by electromagnetic signal waves the passage of such oscillations through the sensitive gaseous conducting medium between the electrodes alters the conductivity thereof and thereby alters what may be termed the internal resistance

of the flame battery constituted by the electrodes and the flame." There is no proof that any "sensitive gaseous medium" ever acted in this manner or that a single wireless message was ever received by this suggested form of "oscillation-responsive device."

In his next patent application the pendulum swings back again in the direction of the Fleming valve, and on February 14th, 1906, we find de Forest making another patent application, No. 837,901, in which he again declares he has "discovered that if a gaseous medium intervening between two separated electrodes be put into a condition of molecular activity by heating the same or otherwise putting it into a condition of molecular activity, said medium becomes highly sensitive to electrical oscillations." The actual instrument figured in the diagrams of this specification is, however, an incandescent electric lamp arranged as an oscillation valve having a projection on the bulb filled with mercury which acts as the cold electrode. An electromagnet is shown in the diagram placed near the bulb, which is said "will greatly increase the sensitiveness of the detector."

This application was followed by another on August 27th, 1906, No. 841,386, in which an oscillation detector is described which is said to have many uses. It comprises now "an evacuated vessel of glass or other suitable material, having two separated electrodes, between which intervenes the gaseous medium which when sufficiently heated or otherwise made highly conducting forms the sensitive element of my oscillation detector." One of these electrodes is to be a carbon or tantalum filament and the other a cold metal plate or pair of plates. In the diagrams the filament is shown connected to a battery through a rheostat and outside the lamp the plates are connected with the lamp filament terminals through a telephone and a boosting battery. In some cases magnets are to be placed outside the bulb or coils of wire surrounding it.

In order carefully to distinguish this oscillation-responsive device from the Fleming valve, to which it had unfortunately so strong a resemblance, a new name for it was coined. It was called an *audion*. The patentee says this name is to include other devices of his invention "employing a conducting gaseous medium as the sensitive element."

It is curious how de Forest returns again and again in his

specification to such meaningless expressions as the above.

2. Having secured, as he no doubt thought, a sound position in regard to patent priority, Dr. Lee de Forest next read a paper to the American Institute of Electrical Engineers, New York, in October, 1906 (see *Transactions, American Institute of Electrical Engineers*, vol. xxv., p. 735, 1906), entitled "The Audion: A New Receiver for Wireless Telegraphy." The paper was discursive and also remarkable for the absence of any correct and proper history of the subject.

The author of it began by giving an account of his Bunsen burner experiments as the foundation of all his work and he then gives a single reference to a paper by Elster and Geitel, published in *Wiedemann's Annalen*, vol. xvi., 1882, and he also gives a diagram taken from one of their subsequent papers. The paper of Elster and Geitel which he quotes—viz., *Wied. Ann.*, vol. xvi., 1882—contains no reference to the diagram he gives of the apparatus, consisting of a glass bulb having a wire stretched across it, intended to be heated by an electric current, and an insulated metal plate placed near it and carried on a wire sealed through the glass (see Fig. 19 of Chap. I. of this book). The title of Elster and Geitel's 1882 paper is "On the Electricity of Flames," and no apparatus is described in this paper such as that de Forest depicts. This bulb was not used by Elster and Geitel until five years later and is described by them in a paper entitled "On the Ionisation of Gases by Incandescent Bodies," printed in *Wiedemann's Annalen* for 1887, vol. xxxi., p. 109.

Moreover, in this 1887 paper, Elster and Geitel only used a *platinum* wire across the bulb, and it was not until two years later, in 1889 (see *Wied. Annalen*, vol. xxxvii., p. 319, 1889), that they experimented with a carbon filament and found that it gave off negative electricity when incandescent.

It was in December, 1889, that the author sent to the Royal Society of London a paper dealing with the "Edison effect" in carbon glow lamps and in the electric arc and the transference of negative electricity from hot to cold electrodes in vacuum bulbs. There is not the slightest reference to this work in de Forest's paper.

This point is important, as it shows clearly the want of care and fairness in collecting information and verifying

THE THERMIONIC VALVE IN

references. Moreover, de Forest refers to the author's prior work in connection with the use of a glow lamp having a plate sealed into the bulb for rectifying high-frequency currents as experiments with an "Elster and Geitel tube" (see below). He then went on to describe as a new invention of his own a detector for wireless telegraphy consisting of a glass bulb evacuated of its air having in it a horseshoe-shaped filament of carbon or tantalum carried on wires sealed through the glass and rendered incandescent by the current from a battery. On either side of the filament were fixed two metal plates he calls "wings" carried on a platinum wire sealed through the glass. Outside the lamp the two plates were connected with the positive terminal of the filament through a circuit containing a galvanometer, a telephone, and a battery of cells having its positive terminal joined to the wings (see Fig. 57).

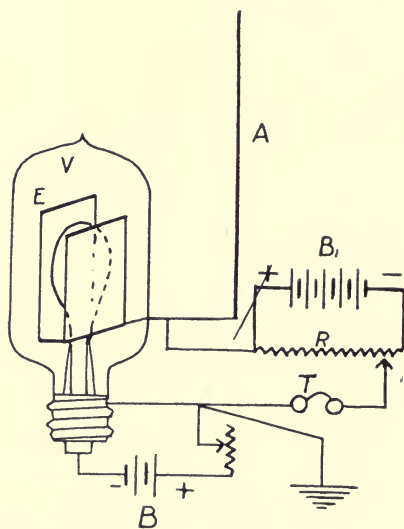

FIG. 57.—Lee de Forest's Two-Electrode Audion of 1906.

No. 841,386.¹ Judging by the discussion which followed, his explanations of the action of his "audion" were not considered very satisfactory and objections were raised to his newly coined name as a bastard and unsuggestive word.

¹ This patent of de Forest was subsequently held by the United States Circuit Court of Appeals to be void. See Appendix for the full text of this important judgment.

Broadly speaking, he attributed the operation to the ionisation of the residual gas by the incandescent filament, but he gave no very clear account of the physical processes at work. As regards the line of thought which led him to invent this detector, he stated that it occurred to him that the attenuated and ionised gases around an incandescent filament would undergo very considerable changes when subjected to Hertzian oscillations. He appeared chiefly desirous of proving that his audion was not an oscillation valve but something very superior to it. He strongly insisted that the important novel element was the use of a voltaic battery in series with the telephone supplying a boosting voltage and that this circuit was connected outside the lamp between the "wing" plates and the *positive* terminal of the incandescent filament.

He felt bound, however, to forestall some mention of the Fleming valve patented in Great Britain nearly two years before, and fully described in the author's book, *Principles of Electric Wave Telegraphy*, published nearly six months before the date when he read his paper. Hence he says, *loc. cit.*: "I have arrived as yet at no completely satisfactory theory as to the exact means by which the high frequency oscillations affect so markedly the behaviour of an ionised gas. Fleming points out that when the cold plate of an Elster-Geitel tube is connected to the positive end of the filament and the two put in a high-frequency oscillation circuit, only the positive half of the oscillation can pass from the plate to the filament across the gas. He uses this principle to rectify the Hertzian oscillations, and applies the unidirectional currents of the oscillations themselves to operate a sensitive galvanometer or direct current instrument for quantitative measurements over short distances. When an independent source of electromotive force is applied in the manner I have described the action becomes quite different. It then operates as a *relay* to the Hertzian energy instead of merely rectifying this energy, so that it can be used directly to give the sense signal."

When, in the discussion, he was asked point blank by Mr. C. D. Ehret to state exactly wherein his audion differed from a Fleming valve, he could only repeat the assertion that his audion was a relay and the valve only a rectifier.

He confidently asserted that the Fleming valve was useless in commercial wireless telegraphy.

He did not know that at that time the author's valve had been in practical use in radiotelegraphy in Great Britain for nearly eighteen months, and that it had been employed with a telephone, as a receiver, just in accordance with the diagram in his paper.

He was quite wrong in asserting that the form of Fleming valve he called an audion was a relay. Later on he did succeed in devising a form of valve, to be mentioned presently, which does or can act as a relay.

The instrument he described in this 1906 paper was simply a Fleming valve, and it did not operate as a true relay. If Dr. de Forest had studied a little more carefully the Royal Society paper of the author published in March, 1905, he would have seen there a series of characteristic curves delineated for one particular valve, showing the relation of thermionic current to potential difference of the plate and filament. These observations were made by inserting a battery in the external circuit joining the plate and filament, exactly as he did in his experiments, but employing a galvanometer as a current measurer. These curves give a full explanation of the action of the valve when used with such a boosting voltage and a telephone in the valve circuit. They show that for a particular voltage, or P.D., the thermionic current rises with great rapidity, and hence that when that critical steady auxiliary voltage is applied, a small additional voltage, such as is obtained by the superposition of an alternating E.M.F. on the steady E.M.F., may give rise to a large increase in the thermionic current.

Every electrical student was also aware long before 1906 that the telephone is sensitive only to *change of current*, and not to steady or unvarying current. Hence when a telephone is used in place of a galvanometer as a signal-recording instrument it is an advantage to add such a boosting or additional steady E.M.F. in the valve circuit as will bring the effective P.D. between filament and plate to that point on the characteristic curve at which the thermionic current begins to rise rapidly. This, however, is not a true relay action.

Summing up the criticism with regard to this paper of de Forest, we may say that there were three facts which

ought in fairness to have been brought to the notice of his audience at the time to enable them to judge of the novelty of this *new* receiver described to them. The first of these was that an exactly similar instrument—viz., an incandescent lamp having a plate or plates sealed into the bulb—had been patented, or patents applied for, as a detector in wireless telegraphy in Great Britain, the United States, Germany, France, Italy and other countries by J. A. Fleming and Marconi's Wireless Telegraph Company months before the date when this paper was read by de Forest. Secondly, that it was not new to introduce a boosting or auxiliary voltage into the external or valve circuit; and thirdly, that Senatore Marconi had used such appliances supplied to him by the author of this book eighteen months before October, 1906, with a telephone as a receiver for wireless telegraphy.

There is no intention of suggesting any want of good faith or integrity on the part of Dr. Lee de Forest. He was at that date evidently quite sure that he had full right to make use of an incandescent electric lamp having a plate or plates sealed into the bulb as a detector in wireless telegraphy, and he was firmly convinced that his substitution of a battery-boosted telephone in place of a galvanometer was an important invention. Exactly ten years later he had these opinions corrected by the judgment of Judge Mayer, subsequently upheld by the Court of Appeals.

3. Shortly after reading this paper de Forest filed another application on October 25th, 1906, for a United States Patent, No. 841,387, entitled "Device for Amplifying Feeble Electrical Currents," and in this we have the first indication of a genuine improvement.

The principal item in this specification is an incandescent lamp having in addition to the carbon or metal loop filament two metal plates sealed into the bulb. This in itself was not novel, because the author had shown in his Royal Society paper of February, 1905, *loc. cit.*, and in the first edition of his book, *Principles of Electric Wave Telegraphy*, published April, 1906 (see Chapter VI.), an oscillation valve with two such cold electrode plates.

Nevertheless, de Forest made a scheme of connections outside the valve as follows:

One of the plates and one terminal (the negative) of the

filament in the bulb were connected to the aerial wire and earth of the wireless receiving set, whilst the second plate was connected with the positive terminal of the filament through a telephone and boosting battery. This arrangement was stated to work in virtue of the fact that the electrostatic attraction of the filament and plate connected to the wireless antenna would draw them together and so vary the distance between the filament and the second plate and thus alter the current through the telephone. It may be doubted very much whether any such attractions could be so controlled as to give rise to the required variations in the thermionic current flowing to the second plate to transmit intelligible signals. Moreover, the thermionic current is not sensibly altered by varying slightly the distance between a hot and cold electrode.

This patent specification, however, contained two claims (4 and 6) for a detector device for *amplifying* electric currents. The wording of them was as follows :

Claim 4.—In a device for amplifying electrical currents, an evacuated vessel, three electrodes, sealed within said vessel, means for heating one of said electrodes, a local receiving circuit, including two of said electrodes and means for passing the current to be amplified between one of the electrodes which is included in the receiving circuit and the third electrode.

Claim 6.—In a device for amplifying electrical currents, an evacuated vessel, a heated electrode and two non-heated electrodes sealed within said vessel, the non-heated electrodes being unequally spaced with respect to said heated electrode, a local receiving circuit including said heated electrode and that one of the non-heated electrodes which has the greater separation from the heated electrode and means for passing the current to be amplified between the heated electrode and the other non-heated electrode.

As these claims constituted the first mention of what may be called a split cold electrode, the two parts being differently connected to the hot electrode, and as this formed the basis of a subsequent patent for a three-electrode amplifying valve of true relay action, the Marconi Wireless Telegraph Company of America, who were the plaintiffs in the action against the de Forest Radio Telephone and Telegraph Company in 1916, confessed judgment as to

the two above claims, 4 and 6, in U.S. Patent No. 841,387, whilst the defendants withdrew issue on claim 5 of the above patent, which reads as follows :

Claim 5.—In a device for amplifying electrical currents an evacuated vessel enclosing a gaseous medium, means other than the received energy for maintaining said gaseous medium in a condition of molecular activity, means for impressing the current to be amplified upon said gaseous medium and a local receiving circuit having its electrodes within said vessel.

On January 29th, 1907, de Forest filed another application for a United States patent for an improvement in oscillation detectors of the type described in his United States Patents Nos. 824,637 and 836,070. These we have already seen are Fleming valves used with a telephone and boosting battery in series connected to the filament and the collecting plate or cold electrode.

The feature of the new specification, No. 879,532, is the introduction of a second cold electrode in the form of a grid placed between the incandescent filament and the other cold electrode plate. The scheme of connections is shown in Fig. 58.

Dr. de Forest gave no explanation in this specification as to the mode of action of the arrangement, but he states that the effect is to give louder sounds in the telephone used as a signal-receiving instrument. He may have been led to try this type of thermionic detector by his previous experiments, but at any rate the result was to furnish for the first time a modification of the thermionic valve which *can* act as a relay or amplifier under certain conditions.

The corresponding British patent to the above was applied for on January 21st, 1908, and is No. 1,427 of 1908 ; but under the Patents and Designs Act of 1907 the date claimed for this British patent is January 29th, 1907, being the date of application for the equivalent United States patent. This British patent of de Forest was, however, allowed to lapse in 1911, and is therefore no longer in force. The name "audion" is now commonly applied in the United States of America to this grid and plate or three-electrode thermionic detector. In Great Britain it is usually called an *amplifying valve*.

Discussions and controversies have taken place over the

THE THERMIONIC VALVE IN

theory of its physical action, and it was the subject of the above-mentioned hotly contested patent action in the United States in 1916 between Marconi's Wireless Telegraph Company of America, as plaintiffs, owners of the United States Patent No. 803,684, of April 19th, 1905, issued November 7th, 1905, granted to John Ambrose Fleming, of London, England; and de Forest Radio Telephone and Telegraph Company and Lee de Forest, as defendants. The suit was brought for infringement of claims 1 and 37 in the above Fleming patent specification by the defendants.

The defendants made counter-claims on various claims of

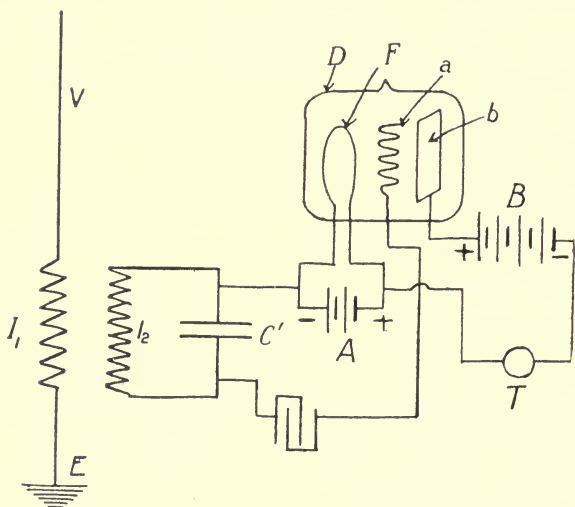

FIG. 58.—LEE DE FOREST'S THREE-ELECTRODE *Audion* OF 1907.
 D, Glass Bulb. F, Filament. *a*, Grid. *b*, Plate. A, Filament Battery. B, Plate Battery. T, Telephone.

ten patents by Lee de Forest. At the opening of the trial plaintiffs confessed judgment as to claims 4 and 6 of United States Letters Patent No. 841,387, and defendants withdrew from issue claim 5 of the same patent. Plaintiffs also confessed judgment as to the claims in issue of United States Letters Patent No. 879,532, and defendants withdrew United States Letters Patent No. 837,901.

Of the counter-claim there remained in issue certain claims of seven patents—viz., Nos. 979,275, 867,876, 867,877,

867,878, 824,637, 836,070, 841,386. These have already been discussed in this chapter. The first four of these concern the Bunsen burner detector and the latter three the two-electrode so-called audion or Fleming valve.

It should be understood that the plaintiffs claimed that *all* the thermionic detectors made or patented by de Forest, whether two-electrode or three-electrode, came within the scope of the claims 1 and 37 of the Fleming United States Letters Patent No. 803,684, which are as follows :

Claim 1.—The combination of a vacuous vessel, two conductors adjacent but not touching each other in the vessel, means for heating one of the conductors, and a circuit outside the vessel connecting the two conductors.

Claim 37.—At a receiving station in a system of wireless telegraphy employing electrical oscillations of high frequency a detector comprising a vacuous vessel, two conductors adjacent but not touching each other in the vessel, means for heating one of the conductors, means for detecting a continuous current in the circuit, and means for impressing upon the circuit the received oscillations. It was the object of de Forest and his allies to prove—

1. That all his detector devices were lineal descendants or logical derivatives of his Bunsen burner detector.

2. That his so-called audion, whether two- or three-electrode, acted upon an entirely different principle to the Fleming valve.

3. That, in any case, the Fleming valve was only an obvious application of Edison's lamp with metal plate fixed in the bulb, or else a mere laboratory experiment, and as such it was open to anyone to appropriate and use this apparatus in radiotelegraphy.

After the case had been thoroughly threshed out by counsel and many expert witnesses called by both sides, judgment was given by District Judge Julius M. Mayer on September 20th, 1916, who heard the case. The full text of this judgment is given in the Appendix to this book. Legal and scientific experts agreed that, having regard to the intricacies of the case and the rather abstruse scientific questions involved, it was a very masterly judgment, exhibiting great insight into the legal and scientific questions at issue and their interpretation.

The judgment was upheld when carried up to the United

States Court of Appeals by the unanimous opinion of three Appeal Judges. The full text of this latter opinion is also given in the Appendix.

Analysing briefly these judgments, they amount to a decision as follows :

(1) De Forest was engaged, prior to November 16th, 1904, on experiments directed to utilising for a radiotelegraphic detector the electrical properties of flames. The root idea of his work was that electrical oscillations passed through a flame or heated gas would render it a conductor. His work in this direction bore no practical fruit.

(2) Fleming was engaged, about the same time, in trying to find a means of rectifying high-frequency oscillations, so as to render them detectable by direct current instruments. He applied for this purpose the Edison (1883) carbon filament lamp with an insulated metal plate sealed into the bulb near, but not touching, the incandescent filament.

This application was patented by him on November 16th, 1904, in Great Britain, as a detector for wireless telegraphy, and the United States Letters Patent corresponding to it—viz., No. 803,684—take date from that point of time.

This application of a known appliance was not obvious, but was new, useful and meritorious, and was a broad patentable invention. It was not anticipated by any publications or patents put forward by the defendants, nor by any of the de Forest patents.

(3) On learning of Fleming's work, de Forest modified his ideas and applied for further United States Letters Patent, in the specifications of which great ingenuity of language was employed, for the purpose of claiming as new inventions instruments substantially identical with that patented by Fleming, but represented as the outcome of his Bunsen burner experiments. His modifications, such as the use of a telephone in series with a source of steady E.M.F., amounted to nothing more than the employment of well-known methods available to anyone.

(4) De Forest did, however, make an improvement of value—viz., the three-electrode valve. Nevertheless, this is not independent of Fleming's claims in No. 803,684.

De Forest's three-electrode valve does not escape infringement of Fleming's claim 37 because the circuit outside

the vessel is divided into two branches, nor because Fleming's detector of a continuous current was a galvanometer and de Forest's a telephone long well known as an equivalent.

Hence the final decision was that the claims 1 and 37 in Fleming's United States valve patent are valid, and were infringed by the defendants in the three-electrode valve. The defendants' counterclaim for breaches of his patents was dismissed, except for those patents on which judgment had been confessed by the plaintiffs.

It was thus settled by legal decisions in the United States that the invention described and claimed in Dr. Lee de Forest's United States Letters Patent No. 879,532 is subject to the fundamental United States Patent No. 803,684 granted to Dr. John Ambrose Fleming, although the former has independent validity and merit as an improvement on the original valve. The Court of Appeal judgment summed up the position in its concluding words, as follows :

“ It is true that Dr. de Forest through the whole line of the counterclaim patents sought after a commercially useful detector, and ultimately produced one ; but it is not true that he consistently followed one concept or theory and tried to reduce that to practice. He began with the heated gas theory, and he ended with the three-electrode audion employing the commercial vacuum, and before he produced that success he learned of Fleming's invention and the latter's address before the Royal Society. He promptly used the knowledge so acquired, and it is the endeavour to connect these differing lines of effort and conceal their lack of normal connection that has produced the theorising of this record, and also the persistent use of the word ‘ audion, ’ as applied even to the earliest of de Forest patents, which are of dates before that word was coined.

“ Among the curiosities of evidence in this record are numerous extracts from technical periodicals giving the opinions of the authors on the subject-matter of this suit. One from *The Electrician*, of November 21st, 1913, is a just comment on the cause : ‘ We think that Dr. de Forest might be more generous in his acknowledgment of the work of Dr. J. A. Fleming. Our readers, generally, will probably

agree that the audion, although differing widely from the Fleming valve, is an offshoot of it.' ”¹

4. Returning, then, to matters more completely scientific, we may first discuss the physical operations taking place in the three-electrode thermionic detector when used as a receiver in wireless telegraphy. Remarks made in connection with the two-electrode valve apply also here. If the bulb is very highly exhausted the phenomena wholly depend upon electronic emission from the heated filament. If, on the other hand, the vacuum is not very high, say, not more than 0.001 mm. or 0.0001 mm., then secondary effects will appear due to the ionisation of the residual gas by the ions or electrons projected from the incandescent electrode. Considering first the case of an extremely high vacuum, we may suppose that the three-electrode valve has its plate connected outside the bulb with a circuit in which is inserted a telephone in series with a primary battery of 10 or 12 cells, the negative terminal of the battery being in connection with the bulb filament, the latter being rendered incandescent by a separate insulated battery of suitable voltage. A current of electrons then flows in the bulb from the hot filament to the plate, and this is called *the plate current*. It may be a few milliamperes in strength. If, then, the grid has a negative charge given to it, this will cause it to repel all or some of the electrons moving towards the plate, and the plate current will be diminished or perhaps arrested. If, on the other hand, the grid is made positive the addition to the electric force in the space between the filament and grid will accelerate the electrons and the plate current will be increased, provided the E.M.F. in the telephone circuit is not too high.

This change in the grid potential relative to the filament will cause a change (decrease or increase) in the plate current, and if this change is sudden a sound will be heard in a telephone receiver included in the plate circuit by an observer. Everything, then, is determined by the form of the *characteristic curve* plotted in terms of difference of potential of the filament and grid as abscissæ and plate

¹ This quotation in the Appeal Court Judgment is from an editorial which appeared in *The Electrician* of November 21st, 1913, on the occasion of publication of a paper by Dr. Lee de Forest, entitled "The Audion-Detector and Amplifier." See *The Electrician*, vol. lxxii., pp. 274, 285, 1913.

thermionic current as ordinates. The potential difference may conveniently be reckoned between the grid and the negative terminal of the filament. Such a curve is delineated in Fig. 59, and we

see that there is a limiting plate current which cannot be exceeded in any case. This current is reached when the rate of delivery of electrons across the interspace is equal to the rate at which they are generated in or ejected from the filament, which final or saturation current is deter-

mined, as we have seen, by the temperature of the filament in accordance with Richardson's formula.

The physical effects have been carefully investigated by Mr. Edwin H. Armstrong and described in a paper in the *Electrical World* of New York for December 12th, 1914, entitled, "Operating Features of the Audion," also in a paper by the same author in the *Proceedings of the Institute of Radio-Engineers of New York, U.S.A.*, vol. iii., p. 215, September, 1915, entitled, "The Audion as Detector and Amplifier."

The plotting of the characteristic curve was conducted by the scheme of circuits shown in Fig. 60, where B_1 is the filament-heating battery, B_2 the boosting battery, and B_3 a potentiometer battery. P is a potentiometer wire with shifting contact, and A is an ammeter for measuring the thermionic current. The potentials and current were also delineated by an oscillograph.

The variation of grid potential and plate current are approximately as represented in the curve in Fig. 4, which shows the manner in which the plate current varies as the grid potential is made + or - to a certain degree.

The three-electrode valve can be used either as a simple rectifier or detector in radiotelegraphic work or as a repeater

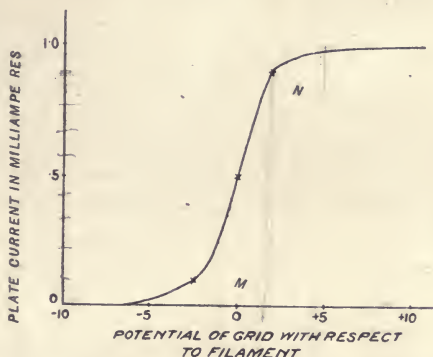

FIG. 59.—Characteristic Curve of Three-Electrode Thermionic Valve

or amplifier by which variations of one current or potential are made to repeat themselves in another current. It is also possible to amplify the scale whilst preserving the same wave form in the variations.

In using the valve as a detector one scheme of connections due to E. H. Armstrong is as shown in Fig. 61.

When a train of high-frequency oscillations is impressed on the grid it causes corresponding high-frequency variations in the continuous current due to the E.M.F. of the battery B_2 flowing in the plate circuit. If, however, we fix the potential of the grid by the potentiometer slider P so as to be

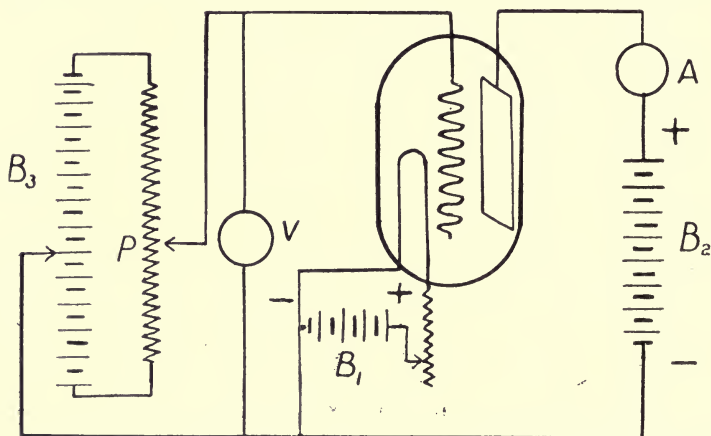

FIG. 60.—Scheme of Circuit for Delineating the Characteristic Curve of a Three-electrode Valve. (E. H. Armstrong.)

near the point M at the lower bend of the characteristic curve (see Fig. 59), then the grid has a steady negative potential superimposed upon the periodic variations, and this implies that in the plate circuit the positive wave amplitude exceeds the negative. If the telephone, T (see Fig. 61), is shunted by a condenser, C_1 , to pass this high-frequency current, the condenser becomes charged positively on the side connected to the battery, B_2 . It then discharges periodically through the telephone at a frequency depending on the constants of the circuit and gives rise to a sound in the telephone which, when regularly repeated, results in a musical note. This discharge is in the same direction through the telephone as the steady plate current from

battery, B_2 , and constitutes an increase in it. The currents in the several circuits were represented by Armstrong

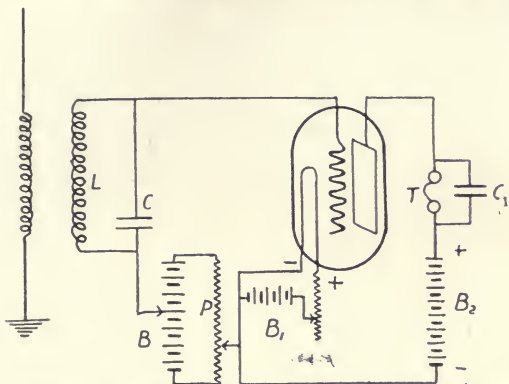

FIG. 61.—Scheme of Connections for Using the Three-electrode Valve as a Simple Oscillation Detector. (E. H. Armstrong.)

diagrammatically as in Fig. 62, and he confirmed the truth of this predetermination by oscillograms taken with relatively low-frequency oscillations.

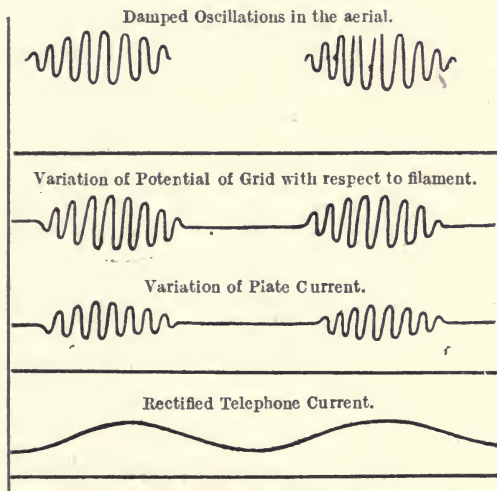

FIG. 62.—Diagram of Current and Potential Variations in Various Parts of the Receiving Circuits in Fig. 61. (E. H. Armstrong.)

If the potential of the grid is adjusted to the upper point, N , on the characteristic curve the fundamental action will

be the same, but the effect of the high-frequency oscillations in the grid circuit on the plate current will be reversed and the periodic discharges of the condenser, C_1 through the telephone will be in the direction of a reduction of the normal steady plate current through them.

We may also use the "valve" or rectifying action in another way. We connect up as shown in Fig. 63. A condenser, C_2 , is inserted

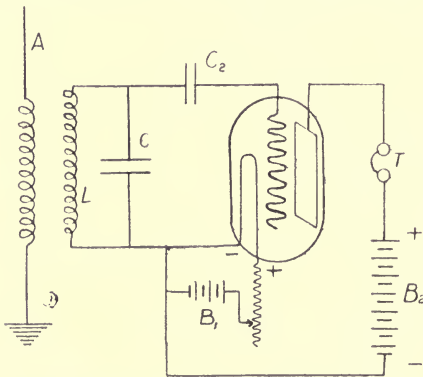

FIG. 63.-Mode of Employing a Three-electrode Valve as a Detector in Radiotelegraphy, making use of the Valve Action between the Hot and Cold Electrodes and of the Amplifying as well as Rectifying Powers.

between the grid and the receiver circuit, C, L , to prevent the passage of a steady current.

When oscillations are set up in the receiving circuit they are rectified in virtue of the unilateral conductivity of the space between the filament and the grid and the side of the condenser, C_2 , attached to the grid becomes charged

negatively and the grid is therefore brought to a negative potential. This charge repels or hinders the electron flow from the filament to the plate, and hence reduces the current through the telephone, thus producing a sound. Armstrong gave the conventional diagram in Fig. 64 to explain the action and confirmed it by oscillographs taken with low-frequency currents.

It may be observed, however, that it is not good practice to insert the telephone directly in the plate circuit. It is better to insert one coil of an oscillation transformer in that circuit and to connect the telephone to the secondary of that circuit. We can then also insert, if need be, a shunted condenser in the plate circuit to give a definite natural frequency.

In addition to using the three-electrode valve as a detector, in which it acts in virtue of the rectifying or "valve" action, we can use it as an amplifier or repeater of current variation,

RADIOTELEGRAPHY AND TELEPHONY

in consequence of the fact that the variation of plate current follows exactly those of grid potential. This depends essentially upon the form of the characteristic curve. If the central portion of that curve is steep or nearly vertical this implies that a small variation in the grid potential will make a large change in the plate current, and this is generally called the amplifying or relay action.

If i is the thermionic current to the plate and v is the potential of the grid, then di/dv is a measure of the rate of change of plate current for a small variation of grid potential.

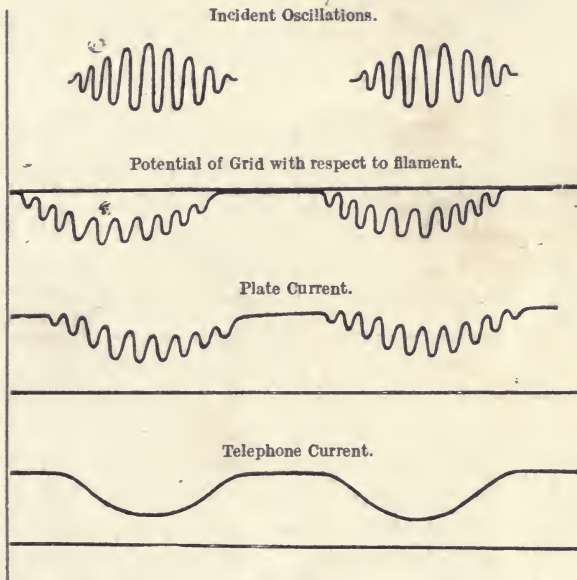

FIG. 64.—E. H. Armstrong's Method of Delineating the Variations of Grid Potential, Plate, and Telephone Currents in the Detector Connections shown in Fig. 63.

If we express by $(di/dv)_{v=0}$, this value at the time when the grid potential is not raised or lowered by any external E.M.F., then this last expression gives us a measure of the amplifying power for small grid voltage variations.

In extremely high vacuum bulbs the central part of the characteristic curve is nearly a straight line (see Fig. 65) at the point of zero potential of the grid, but its slope may be

THE THERMIONIC VALVE IN

altered considerably by even a very small amount of residual gas in the bulb.

It seems tolerably clear, however, that in three-electrode valves as usually made, with not excessively high vacua—that is, not exceeding 0.00001 mm. or, perhaps, under 0.000001 mm.—the amplifying action is to a large extent

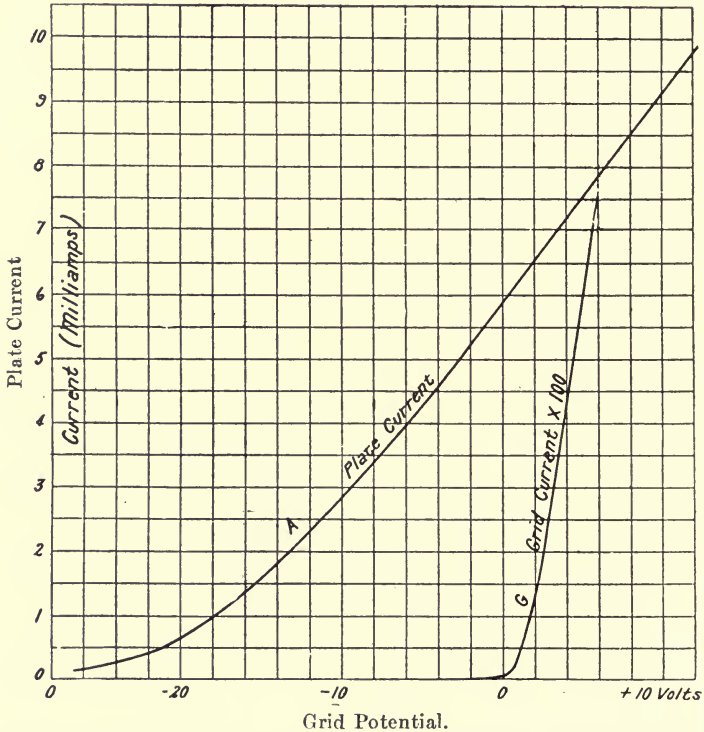

Fig. 65.—Characteristic Curves of High Vacuum Three-electrode Thermionic Valve Detector, called a small Plotron.

dependent upon ionisation of the extremely small amount of residual gas. This ionisation is due to the bombardment of residual gas molecules by the electrons emitted from the incandescent cathode. The positive ions so produced reduce what has been called by Langmuir the *space charge* of negative ions or electrons. If then a small positive potential is applied to the grid the velocity of the electrons

is somewhat increased and more gas ionisation takes place. A slight amount of ionisation brought about in this way very greatly reduces the space charge, and hence increases the negative current which can flow from the filament to the plate anode under a given external E.M.F., and the amplifying action may be increased over and above that which would take place if no residual gas were present. The practical difficulty is, then, to manufacture three-electrode valves so as to secure identity in behaviour, and this is determined by the pressure and nature of the very small amount of residual gas in the bulb.

5. Before considering these matters further it will be best to refer to the various modes of construction adopted in such thermionic amplifiers.

In the construction of these detectors we have to consider (1) the ease of manufacture from the maker's point of view, because a valve of any kind is merely a modified incandescent electric lamp; (2) freeing the metal plates or grids from occluded gases; and (3) the production and preservation of a high or constant vacuum.

Lee de Forest made his first audions with a flat, narrow plate of platinum or other metal placed near to a carbon or metal filament loop in a bulb, and between the plate and filament fixed a grid or simple zigzag of platinum wire (see Fig. 66). This form is comparatively easy to construct because the loop filament, whether carbon or metal, can be fitted to a glass tube stem down which the wires connected to the ends of the filament pass, and the plate and grid can be carried on another similar

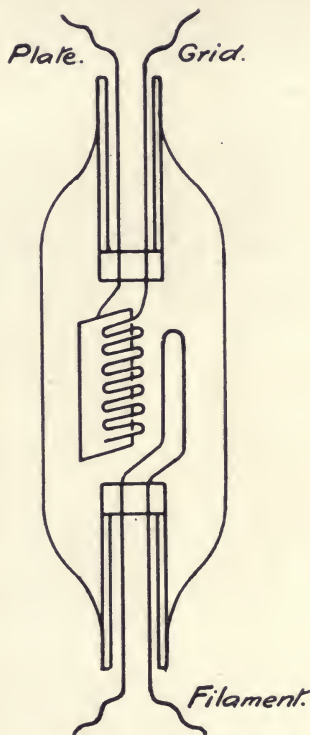

FIG. 66.—Lee de Forest "Audion" on Three-electrode Thermionic Detector.



in the form of a spiral enclosed by and co-axial with the cylinder, but not touching it. The filament is a straight tungsten wire which passes through the spiral without touching. The cylinder, spiral and filament are all carried on wire supports which are attached to a glass stem, and this is enclosed in the bulb, and four wires which are the terminals of the filament and connections to the grid and filament pass down the stem to pins *f, f, g, p*, on the collar. The bulb should be made of hard glass, with small beads of lead glass sealed in, at the places where platinum wires pass through, of the same coefficient of expansion as platinum (see Fig. 67).

The difficulty in connection with these constructions is to free the metal plate or cylinder and grid or spiral from occluded gases by heating to a sufficiently high temperature without softening the glass supports and displacing the parts after they have been sealed into the bulb. It can be done to some extent by strongly heating the whole apparatus whilst exhaustion is going on in a vacuum electric furnace. It is much assisted by sending discharges from an induction coil between the incandescent filament and the grid and plate as the exhaustion of the bulb proceeds.

A form of construction has been adopted by the General Electric Company of America in a three-electrode amplifier to which, for reasons which do not seem very forcible, they have given the name of a *pliotron*.

This instrument is a three-electrode, high vacuum, thermionic detector, in which particular attention has been given to eliminating all effects due to ionisation of residual gas and to produce only those due to a pure electron discharge.

The incandescent electrode consists of a drawn tungsten wire, which is held by hooks on a frame so that it cannot vibrate or be displaced by electrostatic attraction. The grid consists of extremely fine tungsten wire, 0.01 mm. diameter, wound on a frame of glass, silica or metal, the turns of wire being very close, 100 per cm. or more (see *G*, Fig. 68). The second cold electrode may be either two tungsten plates or else a surface formed by winding tungsten wire on a second frame. By making the grid of very fine wire with close turns the current to the plate can be stopped entirely by even a very slight negative potential on the grid.

THE THERMIONIC VALVE IN

Also by giving such a fine grid a small positive potential the plate current can be greatly increased. In other words, by making the grid of very fine wires, with fine interspaces, the amplifying action is increased, whereas if the grid is of coarse wire and with open spaces the magnifying operation is much reduced in scale. With properly designed grids it becomes possible to control large amounts of energy in the plate circuit by very small amounts of energy given to the grid.

In a paper on "The Pure Electron Discharge and Its

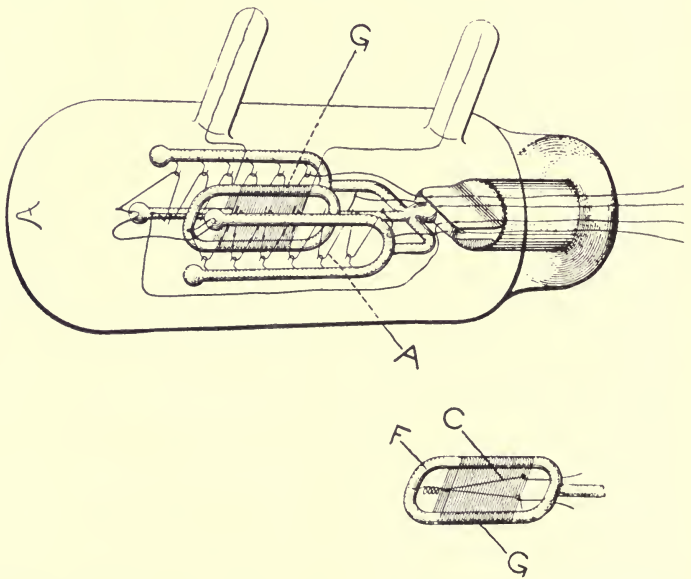

FIG. 68.—High Vacuum Thermionic Amplifier, called a small Pliotron, made by the General Electric Company of U.S.A.

Application in Radiotelegraphy and Telephony," Dr. Irving Langmuir has given descriptions of two types of this three-electrode amplifier or so-called pliotron, as made by the General Electric Company of America.¹ These are called respectively the small and the large pliotron (see Figs. 68 and 69), the former being adapted for use as a radiotele-

¹ See *Proceedings of the Institute of Radio Engineers*, vol. iii., p. 276, September, 1915.

graphic receiver and the latter as an amplifier for controlling power up to 1 kilowatt of power.

The same precautions and methods are employed in highly exhausting these bulbs as in the case of the *kenotrons*, or two-electrode valves, described in Chapter II., made by the General Electric Company of America. The vacuum obtained must be of the order of one hundred-millionth of a millimetre, and especial precautions taken by heating the grid, plate and filament to expel every trace of occluded gas. When these methods are followed, instruments are produced which have identical characteristic curves, because they depend for operation upon pure electron discharge and not upon any accident of ionisation of residual gas.

In Fig. 70 is given the characteristic curve of such a large plotron, showing the plate current in terms of grid potential *plus* or *minus*.

Dr. Irving Langmuir states, *loc. cit.*, that with considerable accuracy the plate or anode current i can be expressed by the formula $i = A (V_a + kV_g)^{\frac{3}{2}}$, where A is some constant and k also a constant depending upon the relative shapes and positions of the electrodes and V_a is the voltage on the anode or plate and V_g the voltage on the grid.

It was found, however, by Mr. W. C. White that the sensitiveness of this plotron as a radiotelegraphic detector is increased by placing in the bulb a small quantity of an amalgam of mercury and silver. This gives rise to traces of mercury vapour in the bulb and it also creates a kink or

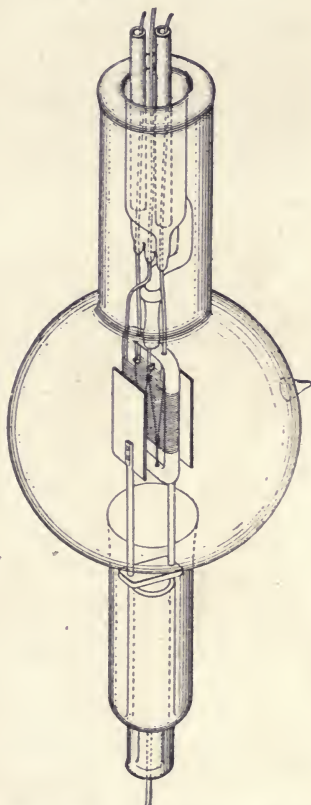

FIG. 69. — High Vacuum Thermionic Amplifier, called a large Plotron.

THE THERMIONIC VALVE IN

sudden bend in the characteristic curve.¹ We have already referred in Chapter II., section 3, to this phenomenon in the case of the two-electrode valve and the author's method of using it to increase the sensitiveness of the detector.

A three-electrode valve relay has also been described and patented by Lieben, Reisz and Strauss, Austrian electrical engineers² In this valve they make use of Wehnelt's

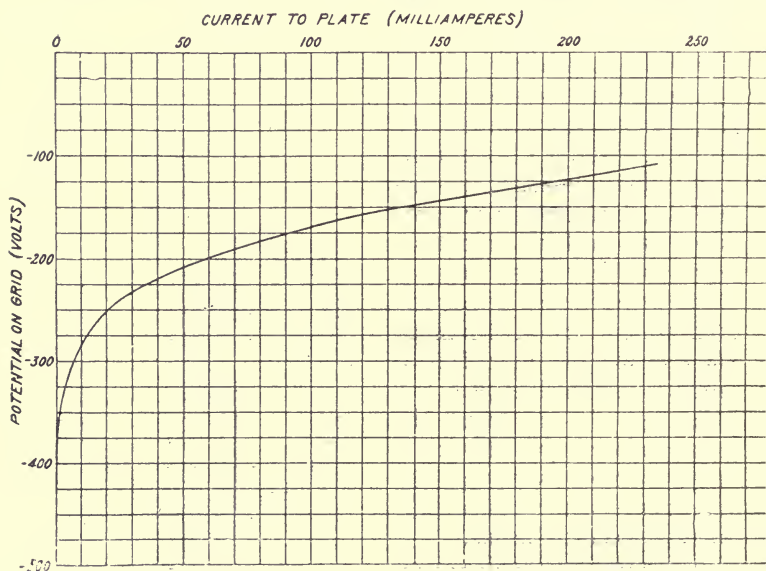

FIG. 70.—Part of Characteristic Curve of Large Pilotron.

discovery that oxides of heavy earths, such as oxides of barium or calcium, when heated, emit electrons freely. Their cathode or hot filament is made of a strip of platinum covered with a thin layer of lime. This is given the form of a zigzag and is fixed at one end of a bulb (see Fig. 71), where *K* is this Wehnelt cathode, consisting of a platinum strip

¹ See United States Patent Specification No. 1,159,307, granted to W. C. White. In this patent specification Mr. White describes the effect of a small quantity of gas in a high vacuum thermion bulb in increasing the anode current.

² See British Patent Specification of Lieben, Reisz, and Strauss, No. 1,482 of 1911; also No. 2,111 of 1911; also *The Electrician*, vol. lxxii., p. 726 (1914), for article by E. Reisz, "A New Method of Magnifying Electric Currents."

1 metre long, 1 mm. wide and 0.02 mm. thick. It is wound on a glass frame and can be brought to a bright red heat at a temperature of $1,000^{\circ}$ C. by passing through it the current from a battery of 30 volts. The bulb is slightly contracted above the cathode, and a grid, G , is fixed across it, and beyond that a twisted wire anode, A . The general appearance of the apparatus is shown in Fig. 72. The bulb is mounted on a box which contains all the circuits and connections. The current to be magnified is passed through the primary circuit of a transformer, T_1 (see Fig. 71), the secondary terminals of which are connected to the grid, G , and a sliding contact on a potentiometer wire, c , which is placed across the ends of a section of the battery. This battery

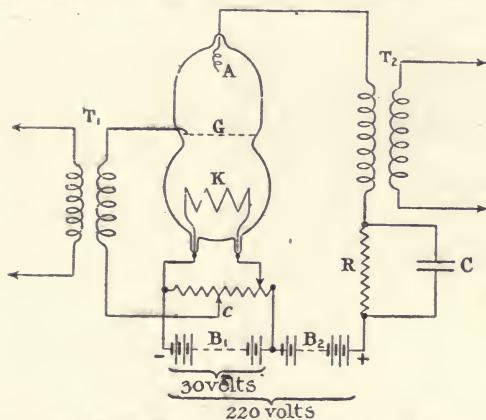

FIG. 71.—Lieben-Reisz Thermionic Relay, with Wehnelt Hot-oxide Cathode.

also sends a thermionic current from the cathode to the anode, and it passes through a transformer, T_2 , from which the magnified current is drawn off, and through a resistance, R , shunted by a condenser, C . The full voltage operating on the last-named circuit is 220 volts.

It will be seen that the variations of potential produced on the grid by the transformation of the feeble current are reflected in variations of the thermionic current passing to the anode. The fluctuating part of this current is separated out from the steady part by the transformer, T_2 , and the condenser, C , shunting the resistance, R , is necessary to pass this variation of current.

THE THERMIONIC VALVE IN

It has been maintained by Eugen Reisz in a letter to *The Electrician*, vol. lxxiii., p. 538, July 3rd, 1914, that the above-described Lieben-Reisz-Strauss relay operates on a principle different from

that of the audion of Lee de Forest.

Reisz traces back the origin of the Lieben-Reisz relay to an invention of Robert von Lieben, described in a German patent specification, No. 179,807, of March 4th, 1906, called a *kathoden strahlen relais* (cathode ray relay). In this a glass evacuated tube had a Wehnelt oxide-covered curved cathode so arranged as to project a cathode beam into a Faraday cylinder and collect the charge and transmit the resulting current through any external telephone or current - detecting instrument. This cathode ray could be deflected so as not to enter the Faraday cylinder by an external electromagnet, or by electrostatic deflecting plates placed inside or outside the vacuum tube. The variation of current through this magnet was

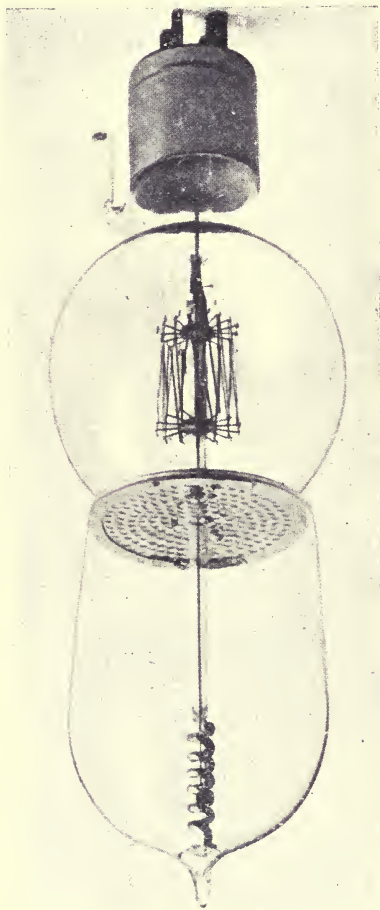

Fig. 72.—Perspective view of Lieben-Reisz Thermionic Relay.

then repeated by the variation in the current drawn from the Faraday cylinder. There is, however, in this case no grid or second anode, and the claim made by E. Reisz for this cathode ray relay as the progenitor of the modern

three-electrode valve cannot be admitted, nor is it likely it would be sustained by any competent legal authority.

The inventors of it subsequently abandoned the cathode ray tube and constructed a true three-electrode relay as above described. The difficulties with early forms of this Lieben relay were the result of variations in gas pressure and ionisation giving rise to great differences in action and requiring frequent adjustments of grid potential and thermionic current. Hence, later on, the bulbs were evacuated very highly and a small quantity of a mercury amalgam introduced into the bulb to provide a source of ionisation in the mercury vapour. With these new conditions the valves keep more constant in action and the inventors claim for them a life of 1,000 to 3,600 hours. They state that a magnification of thirty-three times is obtained with this gas relay and that, using four such relays in cascade, alternating currents of frequencies from 2,000 to 8,000 have been magnified 20,000 times with perfect preservation of wave form. This amplifier is said to be used in Germany as a radiotelegraphic receiver, but the large size of the bulb, which is about 16 in. long and 4 in. in diameter, and the high voltage required (220) in the plate circuit must seriously restrict its use in comparison with other more efficient and compact types of amplifying valve made in Great Britain.

The broad, general conclusion from all this work is that the type of three-electrode or amplifying valve most suitable for general radiotelegraphic work is one in which the vacuum is made initially as high as possible, and the electrodes made of a material, such as tungsten wire, with very high melting point, but in which the necessary provision is made for ionisation by the introduction into the bulb of some volatile solid having a fixed vapour tension at every given temperature. In this manner the minute quantity of gas necessary to produce the amount of ionisation which will give the characteristic curve the required form may be obtained.

For securing good relay action it seems necessary that the characteristic curve should be steep at the point where it crosses the axis of grid zero potential, which implies that at that point a small change in grid potential results in a relatively large change in thermionic current to the anode

THE THERMIONIC VALVE IN

plate. A very usual specification is to require that a change of grid potential from -2 to $+2$ volts shall increase the plate current by 1 milliamperere. The presence of positive ions in the bulb lowers the voltage necessary to produce a certain thermionic current, but it is easy to overdo it, and the problem of successful manufacture is to produce and maintain in action just the right and constant amount of such gas ionisation and no more.

Recent improvements render it possible to specify the

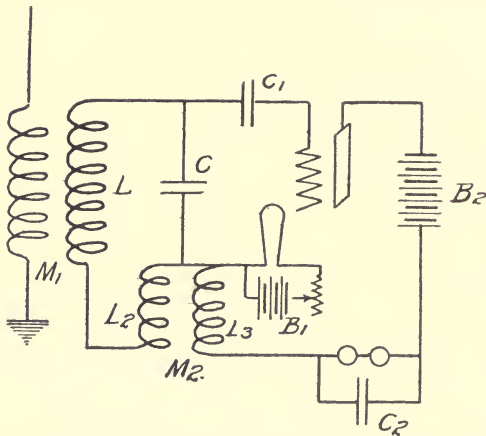

FIG. 73.—Method of Re-enforcing Plate Oscillations by Coupling through a Transformer the Grid and Plate Circuits. (E. H. Armstrong.) (N.B.—In this diagram and that in Fig. 74 the bulb of the three-electrode valve is not drawn.)

vacuum required and enable us to measure it exactly, so that two- or three-electrode valves may be made strictly to specification and absolutely identical when made in numbers, just as is the case with the voltage, wattage, and candle-power of incandescent lamps.

6. In addition to the methods of using the three-electrode thermionic detector above described there are other modes of connection, called regenerative, of the circuits by which the variations of the plate current can be still more magnified or re-enforced by suitable coupling of the grid and plate circuits.

Some of these methods have been described by Mr. E. H. Armstrong in the excellent paper already mentioned. He

says, *loc. cit.*, there are two ways of re-enforcing the oscillations of the grid circuit by means of those of the plate circuit. The simplest way is to couple together the grid and plate circuits by a suitable transformer, $L_2 L_3$, as shown in Fig. 73, and to shunt the telephone by a condenser, C_2 , which acts as a by-pass for currents of high frequency, which the telephone coils would otherwise choke out.

In this case small variations of potential of the grid excite variations in the plate current, and these again are repeated back to the receiver circuit by the transformer, $L_2 L_3$, and reinforce the grid oscillations. To obtain the best result the plate circuit has to be tuned to the oscillation circuit, LCL_2 , by the introduction of suitable capacity or inductance in the plate circuit. When this is done the oscillations in the two circuits react on each other and increase up to a certain maximum value. The energy required for this is, of course, drawn from the battery in the plate circuit.

The second method of re-enforcement given by Armstrong is as follows: An inductance coil L_4 is inserted in the plate circuit and the circuits completed as in Fig. 74. This only differs from the ordinary detector connections as shown in Fig. 63 by the addition of the inductance, L_4 , and condenser, C_2 . Armstrong's explanation of the action of this inductance in amplifying the plate current variations is as follows:

When no oscillations are impressed on this grid the potential difference of the filament and plate will be equal to the voltage of the battery, B_2 , but when grid oscillations are set up causing variations in the plate current the reactance in the inductance, L_4 , creates an E.M.F. which is alternating with or against the battery voltage. When

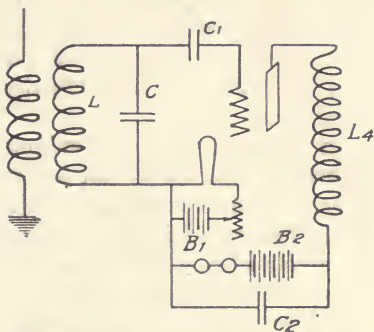

FIG. 74.—Armstrong's Second Method of Re-enforcing the Plate Oscillations in Three-electrode Valve Receiver Circuits. (In this diagram and that in Fig. 73 the bulb of the valve is not shown, but the filament, grid, and plate are denoted by a loop, zig-zag and rectangle respectively.)

a positive charge is placed on the grid the plate current is increased, and the inductive E.M.F. is against the battery voltage producing a decrease in the potential between grid and plate. When the grid becomes negative the plate current is reduced, and the reactance voltage of L_4 is added to that of the battery, and this potential difference between plate and filament and plate and grid is increased. The result of this will be to draw more electrons out of the filament, thereby increasing the charge in the condenser formed by the grid and plate. The increased negative charge on the grid tends to produce a still further increase in the wing current. When the inductance, L_4 , is properly selected the result will be, therefore, to set up a resonance effect which exalts the potential variations of the grid and the current variations of the plate current, and energy from the plate circuit is transferred to the grid circuit and the oscillations in the grid circuit are amplified and rectified. The condenser, C_2 , is necessary to enable the tuning of the plate circuit to be effected.

7. At this stage it should be pointed out that there are two different amplifications which may be effected which are commonly called *radio-amplification* and *audio-amplification*. The former term means an amplification of the amplitude of the high-frequency oscillations, and the latter an amplification of the telephone current variations.

In order that the telephone receiver may emit a continuous sound which can be cut up in Morse code signals of long and short duration the telephone coils must be traversed by an intermittent but unidirectional current, the frequency of these gushes of electricity being about 300 to 500 a second or so. This frequency is called the audio-frequency, being the short for audition frequency.

The loudness of the sounds in the telephone will depend upon the amplitude of these waves of current which pass through the telephone. If they arrive with extreme regularity we obtain a shrill musical note in the telephone, which is interrupted or cut up to form the Morse signals, and the musical sound of these signals enables them to be distinguished from accidental sounds due to atmospheric electric discharges.

A simple scheme of connections for audio-frequency

amplification is shown in Fig. 75, where D is some form of rectifying contact, crystal or valve detector which sends through the coil of a transformer, T_1 , in series with it a unidirectional but intermittent current created by the rectification of trains of oscillations. The transformer, T_1 , which is an iron-cored transformer, impresses corresponding variations of potential on the grid of a three-electrode valve. This, in turn, creates similar variations of current in the plate circuit of the valve, and these again are transformed by a second iron-cored transformer which passes the periodic part of the plate current to a telephone receiver. By suitably designing these transformers the sounds heard in the telephone can be made much louder than if the telephone

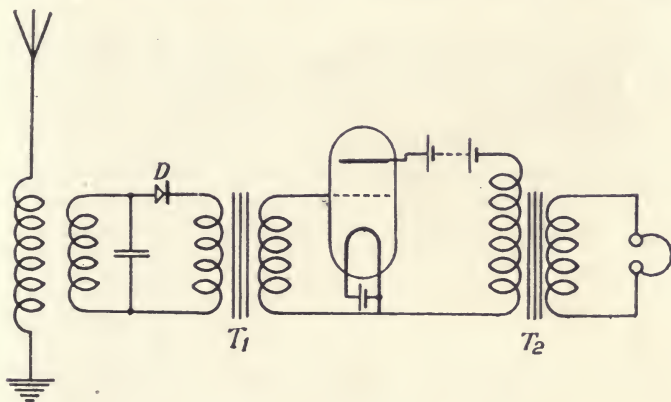

FIG. 75.—Scheme of Connections for Audio-magnification with Three-electrode Valve. The Transformers T_1 and T_2 are Iron-cored. D is the Crystal or other Rectifying Detector.

were inserted in series with the detector, D , alone across the terminals of the receiving condenser.

One set of connections for radio amplification has already been shown in Fig. 63. It is possible to combine in one scheme both radio and audio amplification, as in Fig. 76.¹

In this case the plate current of the first valve passes through the primary circuit of an iron-cored transformer, T_1 , and this circuit is shunted by some rectifying detector,

¹ See an article on "Ionic Valves," by Prof. W. H. Eccles, *The Year-Book of Wireless Telegraphy*, 1917 (The Wireless Press, Limited), p. 689. Figs. 20, 21, 22 are taken from this article.

such as a crystal. The secondary circuit of T_1 is connected to the grid of a second valve, and the plate current of this last valve is transformed by an iron-cored transformer, T_2 , and the energy transferred to a telephone, H .

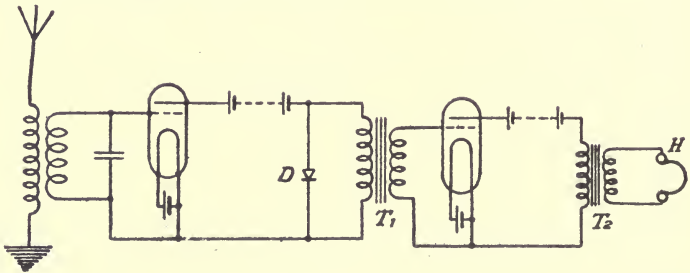

FIG. 76.—Scheme of Connections for Combined Radio- and Audio-amplification by Three-electrode Valves in Cascade, Coupled by an Iron-cored Transformer, T_1 , and Telephone, H , also similarly Coupled by Transformer T_2 . D is the Crystal Detector.

It is possible to effect radio and audio amplification by a single three-electrode valve, as shown in Fig. 77.

8. A very important property of the three-electrode valve is the capability of being used in cascade, so that we can

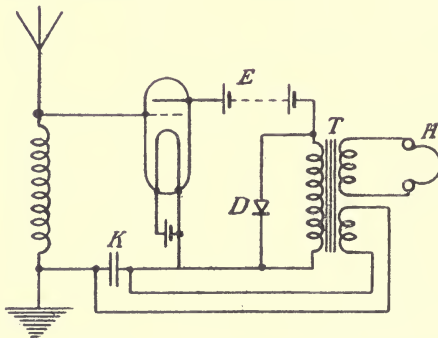

FIG. 77.—Scheme of Connections for Combined Radio- and Audio-amplification with a Single Three-electrode Valve and Double Coupling. T is an Iron-cored Transformer, H Head Telephone, and D is a Rectifying Crystal.

amplify almost indefinitely radio oscillations of very small amplitude by the use of several such valves in series.

As already explained, the amplifying power of a three-electrode valve depends upon the slope of the characteristic curve.

Another factor

of importance is the magnitude of the current taken by the grid. To obtain the greatest amplifying power it is desirable to have this last current as low as possible.

In the case of the small plotron above described the plate current increases at the rate of 1 milliampere per volt change in the grid potential.

By using larger anode potentials the slope of the curve can be made greater, since it becomes possible to use a finer mesh for the grid, and we might obtain a larger variation of plate current per volt of potential change of the grid.

If, however, we couple two valves, as shown in Fig. 78, and by the insertion of an oscillation transformer, *J*, transform variations of plate current of the first valve into

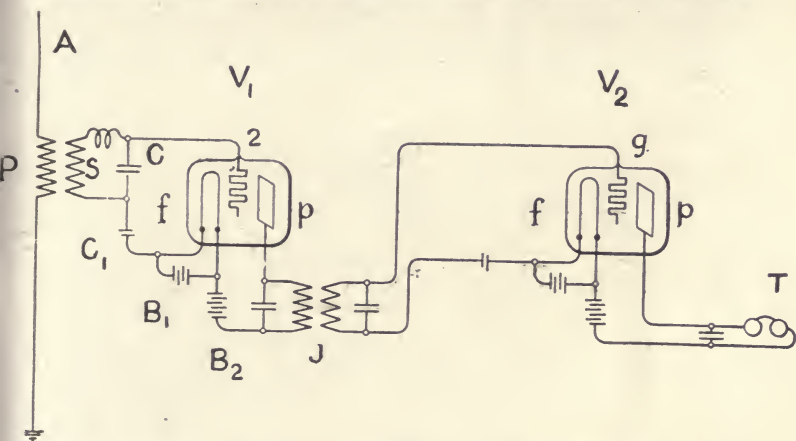

FIG. 78.—Two Three-electrode Amplifiers, V_1 and V_2 , worked in Cascade, being Coupled by an Oscillation Transformer, *J*.

variations of grid potential of a second valve, we can then multiply still more.

An arrangement of two or more valves in this fashion is called use in *cascade*. If the several circuits are carefully tuned the magnification due to n valves in cascade is proportional to a^n , where a is some constant.

The small changes in grid potential are reproduced as changes in plate current, no matter what the frequency may be. Hence, by suitable arrangements of grid and plate valves in cascade, radiotelegraphic signals too weak to be heard on the telephone with a single detector can be amplified until they are quite loud.

9. From the facts already given it will be clear that the

THE THERMIONIC VALVE IN

amplifying power of a three-electrode valve is closely connected with the slope of the characteristic curve at the point of usage. This slope at any point is the ratio of the increment of plate current to the increment of grid potential.

The ratio of a current to a potential difference is of the dimensions of a conductance. If the potential difference is measured in volts and the plate current in amperes then the characteristic slope is measured in *mhos*, or the reciprocal of ohms. One mho is the conductivity of a conductor of one ohm resistance. This conductivity in mhos has been called by Vallauri the valve parameter.

It is necessary therefore to measure it for every three-

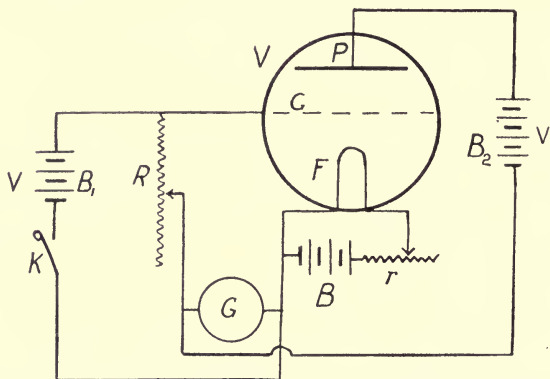

FIG. 79.—Arrangement of Circuits for Measuring Slope of Characteristic Curve. (Captain E. V. Appleton.)

electrode valve, and should preferably be determined at the symmetrical point in the characteristic curve—that is, about the centre of the steeply rising part.

For this purpose it may be found convenient to delineate the whole of the characteristic curve. This can be done by inserting a milliamperemeter in the plate circuit to measure the plate current and applying by a potentiometer known and measured potentials to the grid and then plotting the result on squared paper. The slope can, however, be determined at any point by one single measurement by a convenient method devised by Capt. E. V. Appleton, R.E., which is as follows: A battery, B₂, is placed in the plate and a battery, B₁, in the grid circuit (see Fig. 79), and a

resistance, R , inserted with galvanometer, G , as shown in the diagram. A key, K , is placed in the grid circuit.

When this key is open the galvanometer, G , measures the normal plate current. If the key is closed the galvanometer reading will in general alter. It is possible, however, to adjust the resistance, R , to such a value that the galvanometer reading does not change. When this is the case the reciprocal of the resistance, R , measures the slope of the characteristic corresponding to the plate current at that instant.

This method of measurement was described by Capt. Appleton in an article in *The Wireless World* for November, 1918, p. 458, entitled "A Thermionic Valve Slopemeter."

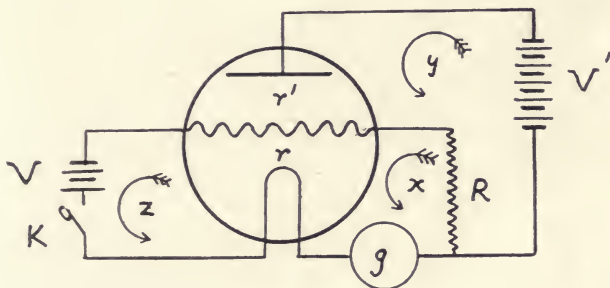

FIG. 80.

Capt. Appleton gives in the above article a proof of the above theorem, but the author has given another proof, as follows :

If we redraw the circuits we see that the arrangement in Fig. 79 is equivalent to the arrangement in Fig 80. Let the resistance of the vacuous space between the grid and plate at the instant considered be r^1 ohms and that between the grid and filament r ohms, and let the resistance of the galvanometer be g ohms, which is negligible compared with r or r^1 . Suppose V to be the E.M.F. of the grid battery, B , and V^1 that of the plate battery, and let the resistance of all connections and batteries be negligible. Then, if R is the variable resistance, it is evident that the arrangement forms a network of conductors, as in Fig. 81. Let x , y and z be the cyclic currents circulating all in a positive direction.

THE THERMIONIC VALVE IN

Then x is the current through the galvanometer and y is the plate current, and V is the grid potential. Hence $\frac{y}{V}$ is the plate current divided by grid potential ($=a$) and is the characteristic slope or conductance the value of which we require. In the first place, suppose the key, K , to be open, then the network becomes a simple two-mesh

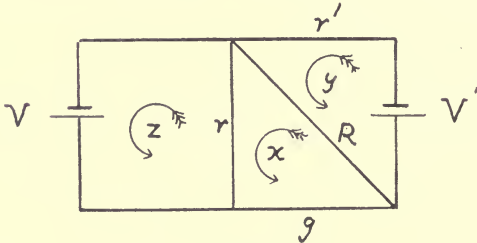

FIG. 81.

network. If we write down the cyclic equations,¹ for the network we have the equations

$$\left. \begin{aligned} -Rx + (R + r^1)y &= V^1 \\ (R + r + g)x - Ry &= 0 \end{aligned} \right\} \quad \cdot \quad \cdot \quad \cdot \quad (1)$$

If the key is closed we have a three-mesh network, and the cyclic equations are

$$\left. \begin{aligned} -Rx + (R + r^1)y + Oz &= V^1 \\ -rx + Oy + rz &= V \\ (R + r + g)x - Ry - rz &= 0 \end{aligned} \right\} \quad \cdot \quad \cdot \quad \cdot \quad (2)$$

Solving these linear equations for x and neglecting g in comparison with r or r^1 , we have the value as the quotient of two determinants—viz. :

From equation (1)

$$x = \frac{\begin{vmatrix} V^1, R + r^1 \\ 0, -R \end{vmatrix}}{\begin{vmatrix} -R, R + r^1 \\ R + r, -R \end{vmatrix}} = \frac{V^1 R}{(R + r)(R + r^1) - R^2} \quad \cdot \quad \cdot \quad (3)$$

¹ For the method of constructing these equations and solving conducting network problems the reader is referred to the author's book, *The Wireless Telegraphist's Pocket Book of Notes, Formulae, and Calculations*, The Wireless Press, Limited, Marconi House, Strand, London.

From equation (2)

$$x = \frac{\begin{vmatrix} V^1, R+r^1, 0 \\ V, 0, r \\ 0, R, -r \\ -R, R+r^1, 0 \\ -r, 0, r \\ R+r, -R, -r \end{vmatrix}}{r(R+r^1)(R+r) - r^2(R+r^1) - R^2r} = \frac{V(R+r^1)r + V^1Rr}{r(R+r^1)(R+r) - r^2(R+r^1) - R^2r} \quad (4)$$

If the value of R is adjusted so that the current through the galvanometer ($=x$) is the same with key up as key down, we can equate the values of x in solutions (3) and (4), and we have

$$\frac{V^1 R}{(R+r)(R+r^1) - R^2} = \frac{V(R+r^1) + V^1 R}{((R+r)(R+r^1) - R^2) - r(R+r^1)}$$

or
$$\frac{V^1}{V} = \frac{(R+r)(R+r^1) - R^2}{Rr} \quad (5)$$

Now the plate current is y , and the value of y with key down is

$$y = \frac{\begin{vmatrix} -R, V^1, 0 \\ -r, V, r \\ R+r, 0, -r \\ -R, R+r^1, 0 \\ -r, 0, r \\ R+r, -R, -r \end{vmatrix}}{r(R+r)(R+r^1) - r^2(R+r^1) - R^2r} = \frac{VRr + V^1r(R+r) - V^1r^2}{r(R+r)(R+r^1) - r^2(R+r^1) - R^2r}$$

Hence the conductivity $a=y/V$ is

$$\frac{y}{V} = \frac{R + \frac{V^1}{V}(R+r) - \frac{V^1}{V}r}{(R+r)(R+r^1) - R^2 - r(R+r^1)} \quad (6)$$

Substituting in (6) the value of V^1/V from (5), we have

$$\frac{y}{V} = \frac{R + \frac{(R+r)(R+r^1) - R^2}{r}}{(R+r)(R+r^1) - R^2 - r(R+r^1)} \quad (7)$$

Simplifying (7), we have

$$\frac{y}{V} = \frac{2}{r^1} + \frac{1}{r} + \frac{1}{R} \quad (8)$$

But r and r^1 are large compared with R . Hence we can say that

$$a = \frac{y}{V} = \frac{1}{R} \quad . \quad . \quad . \quad . \quad . \quad (9)$$

In other words, the reciprocal of R measures the slope of the characteristic, a , provided that R is so adjusted that the current read by the galvanometer does not alter whether the key, K , is open or closed.

Furthermore, suppose a resistance, R^1 , is inserted in series with the plate battery, then we virtually increase r^1 by an amount R^1 , and we can write equation (8)

$$a = \frac{2}{r^1 + R^1} + \frac{1}{r} + \frac{1}{R} \quad . \quad . \quad . \quad (10)$$

Since r is large, we can neglect $1/r$, and we have

$$a = \frac{2}{R^1 + r^1} + \frac{1}{R}$$

or
$$\frac{1}{R} = a - \frac{2}{R^1 - r^1} = \frac{a(r^1 + R^1) - 2}{r^1 + R^1}$$

or since r^1 is large compared with R^1

$$\frac{1}{R} = \frac{a}{1 + \frac{R^1}{r^1}} = \frac{a}{1 + bR^1} \quad . \quad . \quad . \quad (11)$$

This last quantity, $\frac{a}{1 + bR^1}$ is defined by Vallauri as the amplifying power of the valve, and it is measured by $1/R$.

A useful discussion of the Theory of the Thermionic Amplifier has been given by Mr. H. J. Van der Bijl, of the Research Laboratory of the Western Electric Company, New York, in the *Physical Review* for September, 1918 (see Vol. XII., 1918, p. 171). He has found that the relation between the plate circuit current and grid and plate potentials can be expressed as follows :

If the plate circuit has in it a battery having a constant electromotive force, E , and also a resistance, R , external to the bulb, and if the plate current is I , then the plate potential V_p is $V_p = E - RI$.

If the grid circuit contains a battery of constant electromotive force V_g and also an alternator giving a sine curve

electromotive force, $V \sin pt$, then the plate current can be expressed by the formula

$$I = a (bV_p + V_g + V \sin pt + c)^2$$

where a , b and c are certain constants. He gives a number of charts showing the agreement between the predicted and observed plate currents in various cases.

He states that the alternating current impressed on the plate circuit is a linear function of the grid potential.

The original paper must be consulted for details.

CHAPTER IV.

THE THERMIONIC VALVE AS A GENERATOR OF OSCILLATIONS.

1. A very interesting and important property of the three-electrode thermionic valve is that it can act not only as a detector and amplifier, but also as a producer of electric oscillations. This seems to have become clearly understood about the beginning or middle of 1913, and it gave a fresh interest to the study of the properties of the thermionic valve. Perhaps the first to publish a definite statement was Alexander Meissner, an engineer in the employ of the Wireless Telegraph Company of Berlin, but it appears to have been discovered independently by Mr. E. H. Armstrong in the United States, and also by Lieut. C. S. Franklin and Captain H. J. Round, of Marconi's Wireless Telegraph Company, London. It has also been claimed by Dr. Lee de Forest in a letter in *The Electrician* of August 28th, 1914 (see vol. lxxvii., p. 842), as his own origination under a United States patent, No. 943,969. Anyone who looks at this last-named specification will see at once that there is in it no disclosure of the reaction principle which is the basis of the true oscillation generating power of the three-electrode valve. De Forest's above-named specification covers merely the use of a spark gap or discharger of a particular kind, consisting of two balls or plates in an evacuated bulb which contains also an incandescent filament. This was used in various ways as a sort of spark discharger. The patent claims are broad and might be interpreted to include a variety of arrangements.

The first definite mention of the operation of a true thermionic oscillator was probably made by A. Meissner, in a German patent application filed April 9th, 1913.¹ In

¹ The author has not succeeded in finding this German patent specification of A. Meissner in the British Patent Office Library. The last bound volume of German specifications on the shelves is for 1913, after which the war stopped arrivals.

a letter to *The Electrician* of July 31st, 1914 (see vol. lxxiii., p. 702), Meissner states that this device was suggested by him in March, 1913, when working for the Wireless Telegraph Company of Berlin.¹ He employed the Lieben, Reisz and Strauss vacuum tube relay, already described in Chapter III., which had a Wehnelt incandescent cathode of lime-covered platinum. The scheme of circuits was as shown in Fig. 82. Meissner gives in the above article a photographic view of his apparatus.

In Meissner's arrangements a negative current is sent through the Lieben bulb, *V*, from the oxide-cathode, *K*, which is rendered incandescent by a battery, *B*₁, to the

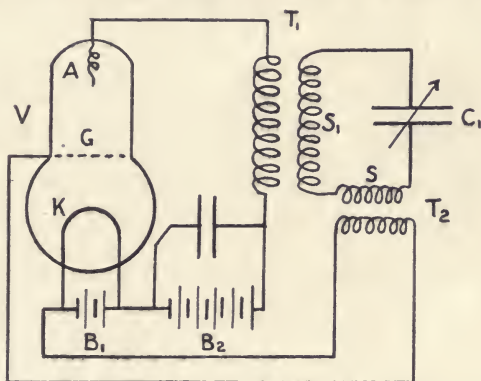

FIG. 82.—Meissner's arrangement of Circuits for using Lieben-Reisz Thermionic Relay as an Oscillation Generator.

anode, *A*. This current is furnished by a battery, *B*₂, of 220 cells, giving 440 volts, the battery being shunted by a condenser. This current flows also through the primary coil of a transformer, *T*₁, of which the secondary circuit is closed by a condenser, *C*₁. The grid, *G*, and the cathode, *K*, are also connected to the primary circuit of another transformer, *T*₂, which effects a coupling between the grid circuit and the plate circuit, through the closed oscillatory circuit, *S*₁, *S*, *C*₁. The physical action which then takes place is closely analogous in principle to that in the well-known experiment called the singing telephone. If an ordinary

¹ The British patent specification for this invention is No. 252 of January 5th, 1914, taken out in the names of Graf Georg von Arco and Alexander Meissner.

carbon granule microphone transmitter is connected through a primary battery of one or two cells with a magneto telephone receiver, and then, if the transmitter and receiver have nearly similar diaphragms, when these are held near to each other the system will emit a clear musical note of a certain pitch, and continue thus to sing as long as the two diaphragms are held near to each other. The reason is as follows: Little noises in the room or a slight tap on the diaphragm of the transmitter set it in motion. The compression of the carbon granules varies their resistance, and hence the current flowing through the receiver. This again causes the receiver to emit a sound, and the aerial waves falling upon the diaphragm of the transmitter set it in sympathetic vibration. This movement again exalts the current variations in the circuit. Hence, by action and reaction, the two diaphragms maintain each other in vibration, the receiver sending out a corresponding sound. The energy required to produce these vibrations is, of course, drawn from the battery in the transmitter circuit.

The action is also similar in some respects to that by which a direct current electric arc sets up oscillations in a condenser circuit having inductance which is shunted across the arc carbons. In these cases we have the energy of a direct current partly transformed into energy of electric or mechanical oscillations. So is it with the case of the thermionic oscillator. We have seen that when a current is flowing from the hot cathode to the cold plate in a three-electrode valve, if the potential of the grid standing between cathode and anode is raised or lowered, the plate current will be increased or diminished in the same manner.

2. If, then, we properly couple together, by a transformer, condenser, or auto-transformer, the grid circuit and the plate circuit we can make the variations of the plate circuit maintain the variations of grid potential, and the latter, in turn, exalt the variations of the plate current. The result is to set up in both circuits rapid undamped electric oscillations or high-frequency alternating currents, the frequency of which may be varied over wide limits. The energy required to create these oscillations is derived from the battery in the plate circuit.

Although Meissner was on right lines in his mode of thus employing the valve, yet the apparatus he used was very

inefficient. The Wehnelt cathode is unsuitable for prolonged practical work, and in low vacuum tubes, such as the Lieben, the cathode is very quickly destroyed by bombardment by positive ions. Hence, Meissner's tube only lasted for a few minutes' use and he obtained a very small output of power into an antenna coupled with it. He states that he obtained 12 watts with a wave-length of 600 metres, and that this corresponded to an antenna current of 1.3 amperes, with an antenna resistance of 12 ohms. He states also that in June, 1913, this generator was used to effect radiotelephony between Berlin and Nauen, a distance of 36 kilometres.

In the British patent granted to Von Arco and Meissner (No. 252, of 1914) the invention is primarily described as "Improvements in and relating to relay arrangements for alternating currents," and a large number of modes of connection of the grid and plate and antenna circuits are shown in the specification diagrams for amplified reception. The use of the arrangement as an oscillation generator was, however, clearly recognised and the thirteenth claim reads as follows:

"13. An arrangement, as in any of the preceding claims, for receiving electric oscillations in which the relay connected by return coupling with a closed oscillation circuit, and thus operating as an oscillation generator, and a receiving antenna act in common on a receiving apparatus comprising a detector and indicating instrument, and in which the frequency of the oscillations generated, due to this relay, is made approximately equal to the frequency of the oscillations received in order to strengthen the oscillations received by interference and to make them perceptible as pure and readily audible sounds."

Another method of explaining the action of the thermionic valve used as a generator has been given by Professor W. H. Eccles in connection with a diagram, as in Fig. 83.

The action has been illustrated as follows:¹ Imagine an oscillatory current circulating in the plate-filament circuit. This oscillation could be kept going by an impulse delivered just at the right moment just as a clock pendulum is kept going by the small impulses given by the pallets

¹ See article on "Ionic Valves," *The Year-Book of Wireless Telegraphy and Telephony*, 1917, p. 683.

THE THERMIONIC VALVE IN

of the escapement. These impulses come from the battery, the E.M.F. of which is, so to speak, turned on at the right moment by the rise in potential of the grid. These variations in grid potential are themselves controlled by the inductive action of the plate oscillation acting through the mutual induction of the coils L and L_1 .

The process may also be compared with the action of a reciprocating steam engine. The steady pressure of the steam in the steam pipe answers to the steady E.M.F. of the battery in the plate circuit. This steam is admitted first to one side of the piston and then to the other, and the mechanism for doing this is the slide valve. But the movements of the slide valve are controlled by the motions of the piston, so that the steam is automatically admitted first above and then below the piston at the right moment.

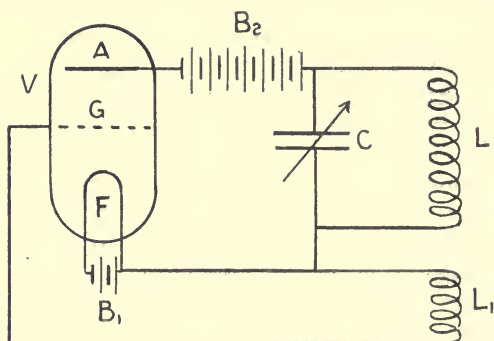

FIG. 83.—Scheme of Circuits for using a Three-electrode Valve, V, as a Generator of Oscillations by inter-coupling Grid and Plate Circuits by Mutual Inductance Coils, L , L_1 .

In the valve the grid answers to the slide valve, and the resulting electric oscillations set up in the plate circuit correspond to the reciprocating motions of the piston.

Hence the thermionic valve is a means of using a direct E.M.F. to produce an alternating current, or what comes to the same thing, pulsations on a direct current. The frequency of these oscillations is determined by the capacity and inductance of the plate and grid circuit, and these must be properly tuned to each other. The coupling of the two circuits must be fairly close to secure these sustained oscillations. Accordingly, the thermionic valve so used

becomes a transmitter and is then described as a transmitting valve.

Since the slide valve controls the admission of the steam and is analogous in function to the grid, the grid circuit is now generally called the *control circuit* and the plate circuit is called the *repeat circuit*.

It is necessary, therefore, that the oscillations in these circuits should be properly in step with each other. The battery in the plate circuit is sending a negative current from filament to plate and this current is reduced when the grid is negative and increased when the grid is positive. Hence the changes in potential of the grid must be in step, or nearly in step, with the changes of current in the plate circuit. This necessitates that the grid potential shall be 90° different in phase from the time rate of change of the plate current.

3. The inductive coupling of the grid and plate circuit, or control and repeat circuit, as they may be called, was quite clearly described by Mr. E. H. Armstrong in a United States patent specification, No. 1,113,149, applied for on October 29th, 1913. He therein describes a number of modes of connection of the control and repeat circuit for the purpose of amplifying the oscillations when the three-electrode valve is used as a receiver. This may be called the re-enforced use of the valve. But he also mentions the resulting property then possessed of creating self-sustained oscillations in virtue of energy drawn from the battery in the plate circuit.

In a letter to *The Electrician* for October 15th, 1915 (see vol. lxxvi., p. 61), Mr. E. H. Armstrong claims the independent discovery of this use of the thermionic valve as a generator of oscillations early in 1913. He also disputes the claim made by Dr. Lee de Forest in *The Electrician* for July 16th, 1915, that the regenerative or reaction principle was disclosed by the latter in his United States specifications, No. 841,387 and No. 879,532 of 1907, covering the two-plate or grid and plate valve. The production of persistent oscillations by a three-electrode valve with grid and plate circuit inductively coupled was also clearly disclosed in a British patent specification, No. 13,636 of 1913, of Lieut. C. S. Franklin and Marconi's Wireless Telegraph Company, applied for on June 12th, 1913, which therefore preceded

Armstrong's United States application by more than three months.

In Franklin's provisional specification it is stated as follows :

"It has been shown that an exhausted tube which contains a heated cathode, consisting of a strip of metal covered with an oxide, and two anodes, one of which is in the form of a plate with holes and which screens the cathode from the other anode, can be used in a wireless receiver for magnifying both the received oscillations and the telephone currents.

"According to this invention when such a tube is used for magnifying the received oscillations we make the circuit in which the magnified oscillations occur react on the circuit in which the oscillations to be magnified occur by coupling these circuits, either electrostatically or electromagnetically to a certain degree.

"If the coupling be too strong the tube will be unstable, and will itself tend to produce oscillations, but there is a certain critical strength of coupling below which the tube is unable to maintain oscillations." We shall refer to this specification again in the next chapter, but the above quotation is introduced here to show that C. S. Franklin quite clearly stated, in June 1913, the conditions under which self-sustained oscillations can take place in a three-electrode valve.

Another mode of inter-connection of the grid and plate circuit in a transmitting or generating valve was described by Captain H. J. Round, of Marconi's Wireless Telegraph Company, London, in 1914, in a British patent specification, No. 13,248, applied for May 29th, 1914. This mode of connection is intended for use with valves of not very high vacua or so-called soft valves. It is shown in Fig. 84, and it will be noted that both the control or grid and repeat or plate circuits contain closed inductance-capacity circuits, P_1K_1 , P_2K_2 , which are usually called oscillating flywheel circuits. The special object of this arrangement was to produce an oscillation-generating appliance for use in the transmitter of a wireless telephone.

The title of the specification is "Improvements in the Production of Continuous Electrical Oscillations and in the Utilisation thereof for Wireless Telegraphy and Telephony."

It will be seen that the plate circuit contains a high tension generator, G , which may be a sufficient number of small storage cells or a small high-tension direct current dynamo. The grid circuit also contains an electromotive force, B_1 , and this is adjusted by the aid of a resistance, R_1 , to obtain the best effect. It is said that the resistance, R_1 , and battery, B_1 , shunted by condenser, K , assist in securing the stability of the tube.

We shall return to the consideration of these regenerative

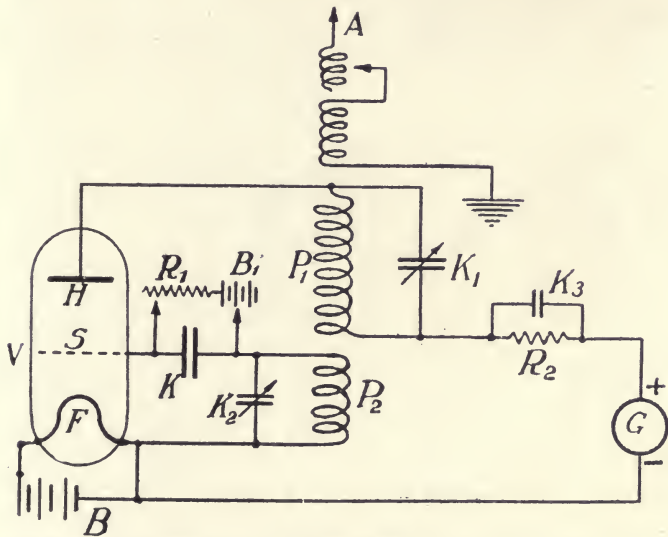

FIG. 84.—Arrangement of Circuits of Three-electrode Valve as an Oscillation Generator due to Captain H. J. Round.

valve arrangements of Franklin and of Round in the following chapters in discussing the use of the thermionic valve in wireless telegraphy and telephony.

4. Meanwhile we may mention two other modifications of such devices for generating respectively oscillations of very low and of very high frequency which are due to Mr. W. C. White, of the General Electric Company of America.¹ These are illustrated in Figs. 85 and 86.

¹ See W. C. White, *General Electric Review*, September, 1916, vol. xix., p. 771, "The Pilotron Oscillator for Extreme Frequencies"; see also United States Patent Specification No. 1,159,307, of W. C. White.

THE THERMIONIC VALVE IN

Fig. 85 shows the arrangement for creating low-frequency oscillations. The reaction between the grid and plate circuits takes place through the iron-cored transformer, T , and condenser, C_1 . The plate circuit contains a direct current dynamo, D , and this is shunted by a condenser, C_2 , of large capacity, about 25 microfarads, to provide a path for the low-frequency oscillations. The inductance on the plate side of the transformer, T , may be about 100 henrys. This transformer has on it a third winding, E , from which a low-frequency alternating current can be drawn off. By means of a variable resistance, R , in the

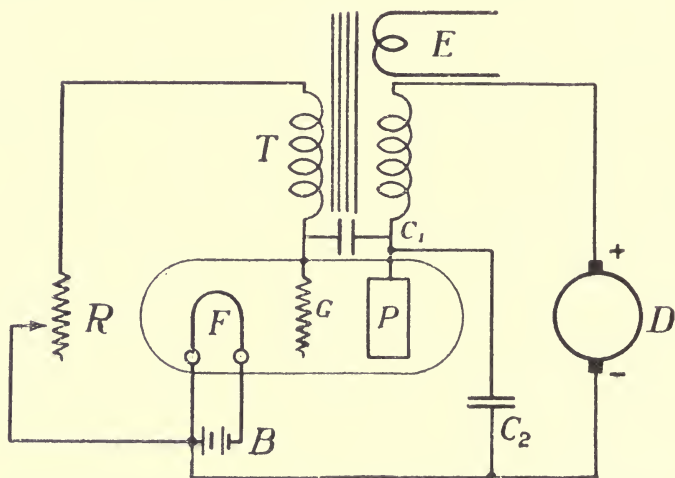

FIG. 85.—Arrangement of Circuits of Three-electrode Valve as a Generator for Low-frequency Oscillations due to W. C. White.

grid circuit the amplitude of the oscillations can be varied, and finally the oscillations damped out. There is a certain critical value of this resistance at which the current in the plate circuit just ceases to be pulsatory. This phenomenon is of importance in connection with a certain method of using the valve as a receiver and amplifier.

The second method, due to W. C. White, is shown in Fig. 86. This is for the production of oscillations of very high frequency.

The grid and plate circuits in this case are tuned by sliding a cross wire, W , along two parallel wires, J , like a

Lecher circuit, which tunes the grid circuit. The condensers, C_2 and C_3 , are of very small capacity. The dynamo, D , supplies direct currents to the plate circuit through two choking coils, L_1 and L_2 , to block out alternating current, whilst a by-pass for the high-frequency alternating currents is given through the condenser, C_1 . Such an arrangement can be tuned up by using very short wires and very small condensers to produce undamped oscillations of 50 millions per second. This corresponds to waves 6 metres in wave length.

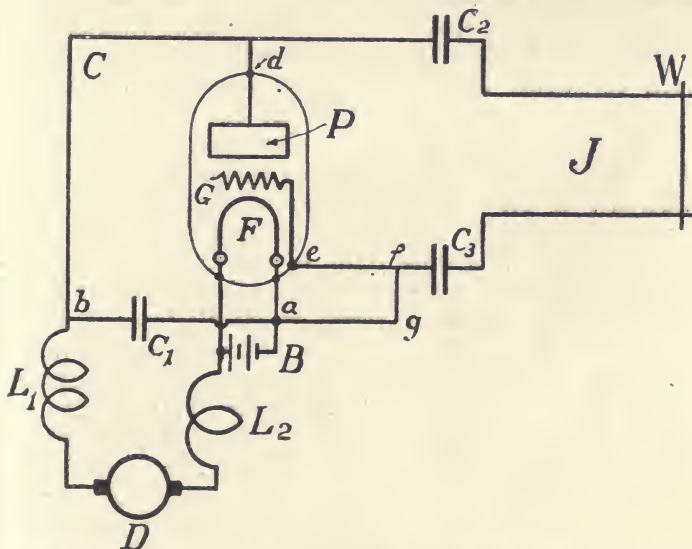

FIG. 86.—Arrangement of Circuits of Three-electrode Valve as Generator of High-frequency Oscillations due to W. C. White.

It will be seen therefore that the three-electrode thermionic valve provides us with the means of producing undamped electric oscillations of sine wave form and of frequencies covering an enormous range, from a few oscillations per second up to 50 million or so.

In order that a generating thermionic valve may operate satisfactorily for prolonged periods of time in oscillation production it must be a high vacuum instrument in which gas ionisation is absent, or else the filament is sooner or later destroyed by positive ion bombardment. Also it is necessary to be able to work a number of valves in parallel to obtain

large currents, and this can only be done when they have identical characteristic curves. This, then, indicates the use of high vacuum valves in which the thermionic current is carried entirely by electrons from an incandescent filament or cathode.

5. A thermionic oscillation generator of very great interest has been developed in the Research Laboratory of the General Electric Company of America, an account of which has been given by Dr. Albert W. Hull in the *Proceedings of the Institute of Radio-Engineers* for February, 1918 (vol. vi., p. 5, 1918). This appliance is a hot cathode vacuum tube possessing a so-called negative electric resistance. It has been christened by the not very suggestive name of a *dynatron*. It is well known that the direct current carbon electric arc possesses the quality that an increase in current through the arc is accompanied by a decrease in potential difference of the electrodes. This is sometimes expressed by saying that the arc has a negative resistance. It is better, however, to state it by saying that the arc has a falling characteristic curve; meaning that the curve which delineates arc current in terms of arc electrode potential

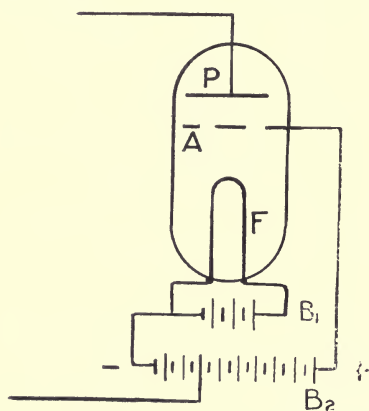

FIG. 87.—Diagram showing the Principle of the Dynatron. F, Tungsten Filament rendered Incandescent by Battery, B₁. A, Perforated Anode and P, Plate Anode.

difference slopes downwards so that increase of arc P.D. implies decrease in arc current.

The dynatron is a high vacuum tube which possesses the same quality in a very marked degree. It belongs to all that family of appliances descended from the Fleming valve which consist of a highly vacuous glass bulb, having in it a filament rendered incandescent by a battery and one or more cold metal plates or grids, which catch or modify the electron discharge from the hot filament or the plates (see Fig. 87). The dynatron utilises, however, the secondary

electron discharge from the hot filament or the plates (see Fig. 87). The dynatron utilises, however, the secondary

emission of electrons from a plate upon which the primary electrons impinge. It can be used as a generator of oscillations and feeds energy into any circuit to which it is connected. It comprises, besides the incandescent tungsten filament, F , a perforated anode, A , and a third electrode, P , called the plate. The plate is fixed near and behind the perforated anode, so that some of the electrons drawn out of the filament shoot through the holes and strike the plate. The filament is rendered incandescent by one battery, B_1 , and another, B_2 , is provided for maintaining the anode at about

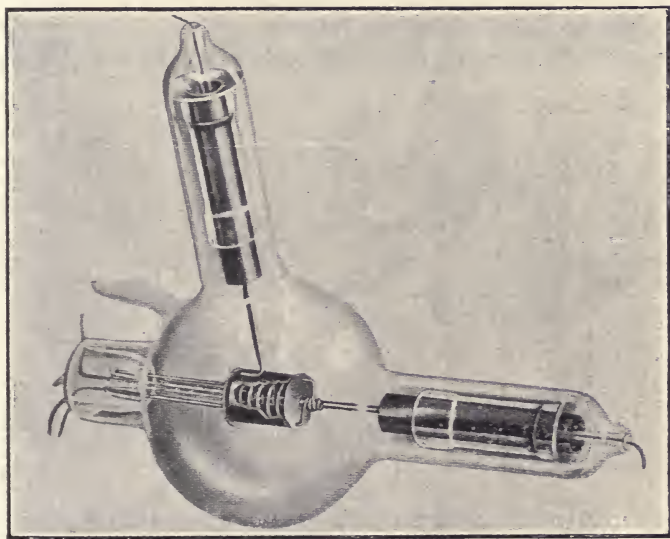

FIG. 88.—Perspective View of the Dynatron.

100 volts potential above the filament. This last-mentioned voltage is not varied and the anode plays no part except to set in motion electrons towards the plate. These strike the plate with great velocity and liberate from it other electrons, called secondary electrons. Fig. 87 shows the general construction and Fig. 88 a perspective view. In practice the plate is a cylinder, and the anode another inner cylinder, full of holes, or else a spiral of wire.

The action is as follows : Electrons are dragged out of the hot filament by the electric force due to the positive potential

THE THERMIONIC VALVE IN

of the anode and shoot through the holes and strike the plate. If the plate is at a low potential with respect to the filament these electrons enter it and form a negative current in the external circuit. If the potential of the plate is raised the velocity with which the electrons strike the plate will be increased, and when this is great enough the primary electrons will ionise surface atoms of the plate and cause the emission of secondary electrons. These will be attracted to the more positive anode, and hence they will diminish the net number entering the plate—that is, will decrease the current into the plate.

The number of secondary electrons emitted increases very rapidly with the potential difference of the plate and filament,

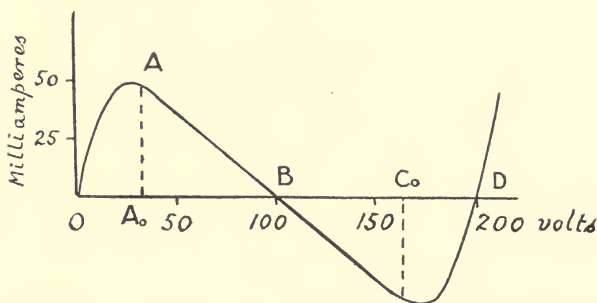

FIG. 89.—The characteristic Curve of a Dynatron, showing the falling characteristic between points A_0 and C_0 .

and may become very much greater than the number of primary electrons.

If we plot a characteristic curve showing the current entering the plate or flowing in the external circuit in terms of the potential difference (P.D.) of the plate and the negative end of the filament, we find that curve to be as in Fig. 89. As the P.D. increases from zero, the current first increases, which means that more and more primary electrons strike the plate. Beyond a certain P.D. of about 25 or 30 volts in this case the current begins to fall off. This is because more and more secondary electrons are emitted from the plate, which reduces the *net* or resultant electron intake of the plate. The current may not only fall to zero, it may become negative, but beyond a certain limiting P.D. the current

again increases positively, because the anode potential is no longer sufficient, compared with the plate potential, to carry away all the secondary electrons.

Hence it is clear that over a wide range of potential of the plate (in the case of the tube here considered it is 50 to 150 volts) the current curve has a negative slope or is a falling characteristic and the tube may be said to have a negative resistance ($= -r$).

Hence, starting from the P.D. at which the thermionic current is zero, we have a considerable range of P.D. over which the current is proportional to the voltage, but is in the opposite direction, so that increase of voltage implies decrease of current or increase of negative current. Therefore we may say that the relation of current ($=i$), P.D. ($=E$), and resistance ($= -r$), is given by the equation $i=E/(-r)$.

The term negative resistance is not a very suitable one, as resistance of any kind is essentially a positive quality. It is the quality of a conductor in virtue of which a current through it dissipates energy. In the case of non-inductive circuits containing no source of electromotive force and for steady unidirectional currents it is measured by the ratio of the volt drop (v) down the conductor to the current (i) in it.

The ratio dv/di can, however, be negative if the current (i) decreases as the P.D. (v) increases.

If the portion of the current-voltage curve where dv/di is negative is a nearly straight line, then we may say that the ratio v/i is negative for that part and denote it by $-r$. The magnitude of this negative resistance for the dynatron and the range of voltage over which the characteristic curve is practically straight depends upon the anode potential, the temperature of the filament and the distance or form of the electrodes. The effect of varying anode potential is to shorten or lengthen the range over which negative resistance exists. Varying the temperature of the filament changes the value of the negative resistance without affecting the voltage range of this part of the characteristic curve.

6. If the dynatron is joined in series with an ordinary metallic resistance the whole circuit taken together has very interesting properties, because part of the resistance being negative and part positive the resultant resistance may be small, and hence a large change in current flowing through

it will be accompanied by only a small change in the total or resultant potential drop down the compound circuit.

In Fig. 90 is shown the arrangement in which R is a metallic resistance and I the current flowing through it and the dynatron. Let v_1 be the volt drop down the resistance R and v_2 that down the dynatron, then $v_1 = IR$ and $v_2 = -Ir$.

Hence, if V is the resultant or applied P.D., we have $V = I(R - r)$ and

$$\frac{v_1}{V} = \frac{R}{R - r}.$$

This can be made a large ratio by making R and r nearly equal. Hence, such a circuit acts as a voltage magnifier of any required amplification. With constant batteries an amplification of one thousandfold can be obtained.

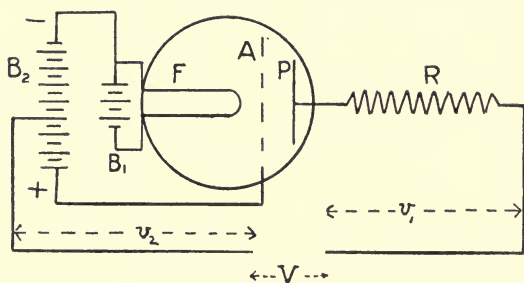

FIG. 90.—The Dynatron as a Voltage Magnifier when used in Series with a Resistance, R .

If the metallic resistance is put in parallel with the dynatron, as shown in Fig. 91, then the arrangement becomes a current amplifier.

Let I be the total current before division between the two parts of the current and let i_1 be the current through the metallic resistance R , and i_2 the current through the dynatron. Then we have

$$I = i_1 + i_2 = E \left(\frac{1}{R} - \frac{1}{r} \right)$$

where E is the volt drop down the resistance R .

Hence
$$\frac{i_1}{I} = -\frac{r}{R - r}.$$

This ratio may be made large by making R and r nearly

equal. The resistance R may be the coil of a galvanometer, relay, or microammeter, and the current I may be any small current it is desired to amplify. Hence, by putting a suitable dynatron in parallel with a relay we can greatly magnify a current to be relayed.

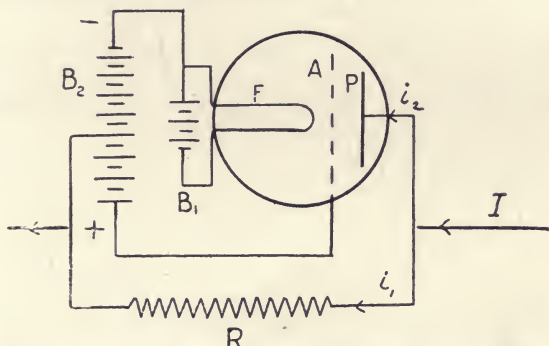

FIG. 91.—The Dynatron used as a Current Magnifier in Parallel with a Resistance, R .

7. A third and very interesting use of the dynatron is for generating oscillations, which can be done as follows :

Let a dynatron be arranged in series with a circuit comprising an inductive resistance of inductance, L , and

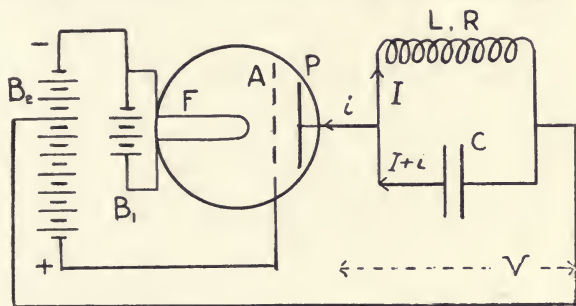

FIG. 92.—The Dynatron used as an Oscillation Generator in Series with a Circuit having Capacity, C , and Inductance, L .

resistance, R , and a condenser of capacity, C (see Fig. 92). Let I be the current through the inductive resistance and V the potential fall down it, and let i be the current through the dynatron. Then $I+i$ is the current through the condenser.

Then the following equations hold good :
For the inductive resistance we have

$$L \frac{dI}{dt} + RI = V \quad . \quad . \quad . \quad . \quad (1)$$

For the condenser,

$$I + i = -C \frac{dV}{dt} \quad . \quad . \quad . \quad . \quad (2)$$

For the dynatron,

$$i = -\frac{V}{r} + i_0 \quad . \quad . \quad . \quad . \quad (3)$$

where i_0 is some constant.

Eliminating V and i we have the equation

$$\frac{d^2I}{dt^2} + \left(\frac{R}{L} - \frac{1}{rC}\right) \frac{dI}{dt} + \frac{1}{LC} \left(1 - \frac{R}{r}\right) I + \frac{i_0}{LC} = 0.$$

The above differential equation has two solutions determined by the algebraic sign of

$$\left(\frac{R}{L} + \frac{1}{rC}\right)^2 - \frac{4}{LC}.$$

If this last is a negative quantity—that is, if $\frac{1}{LC}$ is greater than $\left(\frac{R}{2L} + \frac{1}{2rC}\right)^2$ —then the proper solution of the differential equation is

$$I = \frac{i_0}{R-r} + A e^{-\left(\frac{R}{2L} - \frac{1}{2rC}\right)t} \cos \left(\sqrt{\frac{1}{LC} - \left(\frac{R}{2L} + \frac{1}{2rC}\right)^2} t - \alpha\right)$$

where α is a phase angle and A is some constant.

The above is the expression for a damped oscillation of which the damping factor is $\frac{R}{2L} - \frac{1}{2rC}$ and the frequency n is

$$\frac{1}{2\pi} \sqrt{\frac{1}{LC} - \left(\frac{R}{2L} + \frac{1}{2rC}\right)^2}.$$

The term $\left(\frac{R}{2L} + \frac{1}{2rC}\right)^2$ is in practice very small compared with $\frac{1}{LC}$, and hence we can say that the frequency of the oscillations is $\frac{1}{2\pi\sqrt{LC}}$.

Two cases therefore have to be distinguished—viz., those in which the damping factor $\frac{R}{2L} - \frac{1}{2rC}$ has a real positive value and that in which it is negative.

In the first case the oscillations when started die away, but the decrement may be made as small as possible by adjusting R , L , C and r so that the above damping factor is small. The criterion that the system shall generate oscillations is that: $\frac{R}{2L} - \frac{1}{2rC}$ shall be zero or less than zero—that is, Rr must be equal to or less than L/C .

It is found in practice that this condition can be fulfilled over a wide range of values of $1/2 \pi \sqrt{LC}$, and therefore that it is possible to make the dynatron a generator of oscillations of controlled frequency.

The wave form depends on the values of L/C and Rr . If these quantities are nearly equal the wave form will be a nearly perfect sine curve but with increasing distortion as the ratio of L/C to Rr increases. This has been proved by Dr. Albert W. Hull experimentally (*loc. cit.*).

Hence the dynatron satisfies the requirements for a radio generator. Its efficiency, however, is low, probably not more than 50 per cent., but in the case of small power outputs this is not a serious matter. So far the largest size constructed will give about 100 watts output in high-frequency oscillations.

8. A modification of the dynatron, which has been called a *pliodynatron*, is constructed by enclosing the incandescent filament in a grid or spiral of wire and bringing this spiral to a fourth terminal sealed through the glass. The grid is surrounded by a perforated cylinder which forms one anode and this again by another unperforated cylinder which forms the plate. These various electrodes enclose the filament without touching it or one another. The instrument is then a four-electrode hot cathode vacuum tube (see Fig. 93). The grid potential can be varied by external means, as in the case of the three-electrode valve.

By giving the grid a positive or a negative potential we can vary the number of electrons leaving the hot cathode, and therefore vary the negative resistance of the tube. The negative resistance decreases with increasing grid potential and is inversely proportional. Hence, if the

THE THERMIONIC VALVE IN

tube is connected as above described to an oscillatory circuit and is creating oscillations, a slight decrease in grid potential will stop the oscillations.

If the negative resistance part of the characteristic curve is not straight, but curved, then the oscillations are not abruptly stopped, but their amplitude is decreased in value when the grid potential is reduced. This is exactly what is required in a generator for radiotelephony, in which we require to control the amplitude of the oscillations by the varying current passing through a microphone.

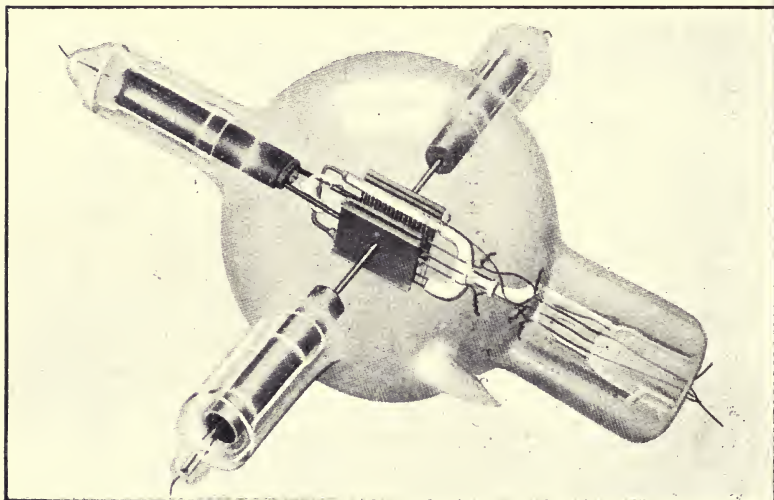

FIG. 93.—Perspective View of the Pliodynatron, a Four-electrode Thermionic Amplifier.

We shall return again to this matter in Chapter VI., dealing with radiotelephony. The pliodynatron can also be used as a powerful voltage amplifier, as explained in the next chapter.

9. We must now proceed to consider a little more in detail the conditions under which self-sustained oscillations can be produced by a three-electrode valve with a battery or source of direct E.M.F. in the plate circuit.

In the present treatment we shall to some extent follow that in a paper on "Oscillating Audion Circuits," by Professor L. A. Hazeltine, published in the *Proceedings*

of the Institute of Radio Engineers, New York, vol. vi., p. 63, April, 1918.

We must refer again, in the first place, to the characteristic curve of a high vacuum three-electrode thermionic valve which for shortness sake we shall call a *thermion*. Although this term has already been used by Professor Richardson to designate the ions emitted by incandescent bodies, there seems no great objection to employing it to describe briefly an instrument which essentially depends upon this emission.

Every thermion has one such characteristic curve (see Fig. 94), in which ordinates denote plate currents and abscissæ grid potentials for a given temperature of the filament, the grid potentials being reckoned from that of

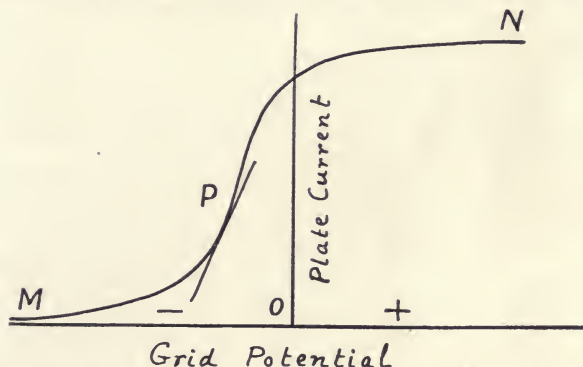

FIG. 94.—Characteristic Curve of a Three-electrode Thermion.

the negative end of the filament, which we shall call zero grid potential. The origin of the curve is taken at zero grid potential and the intercept of the curve on the vertical axis through the origin is the normal plate current. This normal plate current is fixed not only by the filament temperature and distance, size and shape of the anode plate, but by the E.M.F. of the battery in the plate circuit. For a good type of valve this normal current may be 4 to 5 milliamperes when 100 volts are applied between filament and plate.

When the grid is made positive this normal plate current increases, but not indefinitely. It reaches a certain saturation or maximum value beyond which increase of grid potential has no effect. If the grid is made negative the

plate current falls asymptotically to zero. It is convenient in some respects to select a normal plate current corresponding to half the saturation value—that is, to select as the origin a point symmetrically situated as regards change of plate current.

The effectiveness of the thermion as a relay depends chiefly on the slope of the characteristic curve near the origin. This slope, being measured by the quotient of plate current by a grid potential, is of the dimensions of a conductance, and has been called by Hazeltine the *mutual conductance* of the grid towards the plate and denoted by the letter g .

In considering the thermion as an oscillation producer we may neglect the constant or steady part of the currents or voltages and fix attention only on the alternating or periodic part. In the same way it is convenient in diagrams to omit the filament-heating battery and plate circuit battery and to denote the thermion by a conventional symbol consisting of a circle with a loop, zigzag and bar in it to

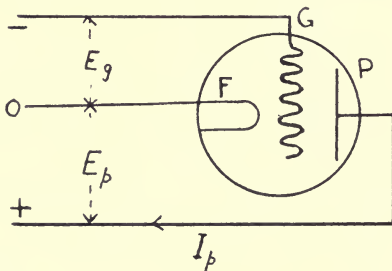

FIG. 95.—CONVENTIONAL DIAGRAM REPRESENTING A THREE-ELECTRODE THERMION.

The symbols for the filament and plate batteries are omitted. F denotes the Filament, G the Grid, and P the Plate. E_g is the Potential of the Grid, and E_p that of the Plate with respect to the Filament, I_p is the Plate Current.

signify the filament, grid and plate. The effective or root-mean-square value of the periodic potential difference of filament and grid is called the “grid voltage,” and denoted by E_g . The same for filament and plate is called the “plate voltage,” E_p , and the periodic part of the plate current is denoted by I_p (see Fig. 95), these being the usual positive current-direction values:

If g is the mutual conductance, then $I_p = E_g g$. If at any moment the plate is positive with respect to filament there is an output of power from the thermion equal to $P = E_p I_p$, and therefore to $E_p E_g g$. Hence, if the thermion is to act as an oscillation generator, we must have $P/E_g E_p = g$ equal to

some possible value of the mutual conductance as derived from the characteristic curve. The smaller, within limits, the value of $P/E_g E_p$, the more easily will the thermion oscillate. If the thermion is connected to an oscillation circuit consisting of an inductance, L , and a capacity, C , then oscillations can be set up in this circuit of frequency $n=1/2\pi\sqrt{UL}$.

It is important to notice that in relation to impressed impulses of this frequency such an oscillation circuit behaves as if it were a nearly non-inductive circuit, and current in it is therefore in step with impressed voltage or E.M.F.

Such a circuit has been called a *flywheel circuit*, because the thermion acts the part of piston and slide valve, whilst the battery in the plate circuit supplies the power and is like the steady steam pressure in a steam pipe leading to the cylinder. There must, therefore, be a certain proper coupling between the oscillation or flywheel circuit and the grid and plate circuits, just as in a steam-engine the crank couples the piston to the flywheel, and the eccentric couples the slide valve to the piston and crank in proper phase relation. Since the plate current is at a maximum when the grid potential is positive and at a maximum, and since the time-rate of change of the plate current is 90° different in phase from the current itself, it is easy to see that if the plate circuit is coupled through an air-core transformer to the oscillation or flywheel circuit, the secondary E.M.F., and hence current induced in the oscillation circuit, will be 90° in phase behind the plate current. If, then, the oscillation circuit is coupled through another air-core transformer with the grid circuit the E.M.F. in the latter, and therefore the grid potential, will lag 90° behind the oscillation circuit current, and therefore 180° behind the plate current. But by a proper connection of the circuits the grid potential may therefore be caused to be positive and at its maximum when the plate current is a maximum, and to be a zero potential when the plate current has its mean value and a negative maximum when the plate current is at its minimum value. This secures the right phase relation of grid potential and plate current. Over and above the statement as to the correct phase relation of the currents, potentials and electromotive forces in the plate, grid and oscillation circuits we have to explain how

it comes to pass that the battery in the plate circuit provides energy to maintain the oscillations. The oscillation and plate circuits possess resistance in their metallic circuits which, small though it may be, dissipates energy and damps out free oscillations. Hence, in order that these oscillations may be maintained, the battery must provide power equivalent to the I^2r losses in the several circuits, where I is a current and r the ohmic resistance of the circuit in which it flows. The resistance of the plate circuit is partly metallic or constant, consisting of that of the wires and internal battery resistance, and partly due to the resistance of the highly-rarefied gas or of the vacuous space between plate and filament. This latter part has a conductivity which is a function of the current through it, and it increases with the current within certain limits. Corresponding, then, to the rising part of the characteristic curve we may draw a conductivity curve which is concave upwards, showing that the conductivity of the vacuous portion of the circuit increases with the current. Hence, if we consider that the normal current sent by the battery through the plate circuit is first increased by a certain amount and then decreased by an equal amount, the work done by a battery of constant E.M.F. will be increased in the first case by a larger amount than it is decreased in the second case, provided we are working at a suitable point on the characteristic. It follows from this that when the plate current oscillates more power is drawn from the battery than when the plate current remains steady or constant.

Part of this excess power is transferred by the coupling to the oscillation or flywheel circuit and serves to maintain the oscillations in spite of the damping due to resistance, and the impulsive electromotive force necessary to counteract the damping is applied just at the right instant and in the right direction—viz., when the current in the oscillation circuit is just beginning to flow. We may therefore consider the result of the periodically varying grid potential to be that the conductivity of the vacuous space is thereby changed so that it is increased when the grid is positive and decreased when the grid is negative, but in such fashion that for equal increments and decrements of plate current the battery is called upon to give more power during the increase

than during the decrease, although on the whole yielding an increase of power whilst the current oscillations last. This excess of power furnishes that required to supply the energy loss due to the resistance of the circuits in which oscillations are taking place. The simplest form of thermionic oscillation-creating circuit is that delineated in Fig. 82, in which the plate and grid circuits are both coupled by air-core transformers to the oscillation or flywheel circuit. The plate or repeat circuit may be called the piston circuit and the grid or control the slide-valve circuit, to keep up the valid analogy with the steam-engine. We

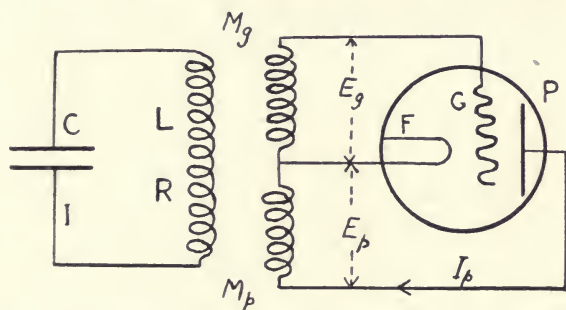

FIG. 96.—Conventional Diagram showing Connections for Establishing Undamped Oscillations in a Condenser-inductance Circuit, C, L, R , by a Three-electrode Valve, provided $g = C L R / M_g M_p$.

can obtain an expression for the conditions which must hold in order that oscillations may be produced in the circuit in Fig. 96, as follows :

Let R be the resistance of the oscillatory or flywheel circuit and consider that the resistance in the battery or plate circuit may be neglected.

Let I be the current, C the capacity and L the inductance of the flywheel circuit, and let M_p and M_g be the mutual inductance of the coupling of the flywheel and plate or grid circuits respectively. Let g be the mutual conductance of plate and grid circuit as above defined. Then $g = \frac{I_p}{E_g} = \frac{P}{E_p E_g}$ as above. But P must be equal to $I^2 R$ and $E_g = I p M_g$; also $E_p = I p M_p$, where $p = 2\pi n$, and n is the frequency of the oscillations.

Hence, substituting, we have

$$g = \frac{R}{p^2 M_g M_p} = \frac{CLR}{M_g M_p}$$

since $p^2 = 1/CL$

But the quantity, $CLR/M_g M_p$, must fall numerically within the possible limits of the value of g , as given by the characteristic curve of the thermion. It is easy to see that g cannot exceed a certain value—viz., the tangent of the angle of slope of the characteristic curve at the origin. Also, there is a lower limit to the value of g —viz., the ratio of I_p/E_g when I_p reaches its saturation value. Oscillations will, therefore, only be produced if $CLR/M_g M_p$ falls within these limits. This generally implies that the coupling of the transformers must be close.

There are a very large number of ways in which the grid

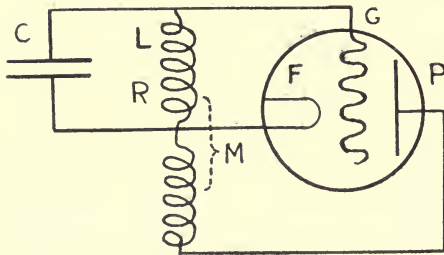

FIG. 97.—Conventional Diagram illustrating the Production of Oscillations in a Condenser Circuit. C, L, by a Three-electrode Thermion, provided $g = C R/M$.

and plate circuits can be coupled so as to produce persistent oscillations by the thermion.

A number of such possible schemes of connection are given in the paper by Professor L. A. Hazeltine (*loc. cit.*).

One such connection, which has been much used, is as shown in Fig. 97. It is the basis of one of E. H. Armstrong's methods of using the thermion. The plate circuit is inductively coupled with the inductance, which is a shunt across the condenser in the tuned grid circuit.

With the same notation as above we can obtain the oscillation condition as follows :

We have, as before, $g = \frac{I_p}{E_g}$, but $E_g = -\frac{I}{j p C}$ if we assume that I and E_g are vectors and j has the usual signification

of $\sqrt{-1}$. Also, we can express in complex notation the fact that the total voltage round the oscillation circuit is zero by the equation

$$I \left(R + jpL + \frac{1}{jpC} \right) + I_p jpM = 0$$

Eliminating I and I_p by the help of the expressions $I_p = E_g g$ and $E_g = -I/jpC$, we have the expression

$$R + jpL + \frac{1}{jpC} - \frac{M}{C} = 0$$

Hence $p^2 = 1/CL$, and $g = CR/M$.

Accordingly the value of CR/M must fall within the

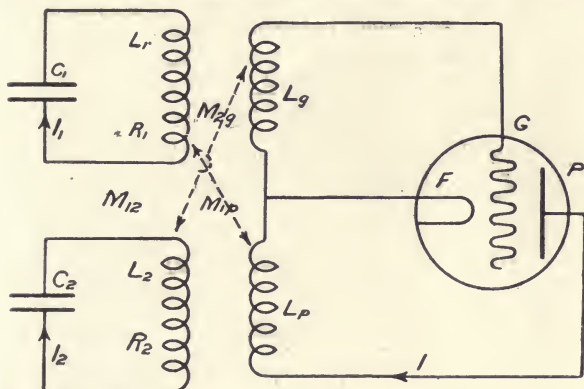

FIG. 98.—Scheme of Connections of Three-electrode Thermion Coupled to Two Oscillatory Circuits:

$$g = \frac{C_1 R_1 + C_2 R_2}{M_{1p}}$$

limits of a possible value of g , as derived from the characteristic curve.

It is evident, therefore, that we can derive the condition for oscillations either by equating the power loss in the oscillation circuits to the output of power by the thermion—viz., $P = gE_g E_p$, or by writing down a set of complex expressions indicating that the total voltage in passing round each network or cycle of the system is zero.

This latter method gives exact results and can be applied to any scheme of connections, however complicated. Thus, for instance, let us consider the more complicated case delineated in Fig. 98. Here we have not only a plate, grid

THE THERMIONIC VALVE IN

and oscillatory circuit, but a second oscillatory circuit inductively connected with the first oscillatory circuit. This latter may be called an auxiliary circuit.

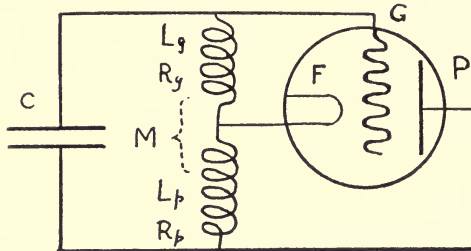

FIG. 99.—Scheme of Connections of Three-electrode Thermion, Coupled to a Single Oscillatory Circuit.

$$L = L_g + L_p + 2M \quad R = R_g + R_p$$

$$g = \frac{C L R}{(L_g + M)(L_p + M)}$$

Let I_1 and I_2 be the currents in the two oscillatory circuits and I_p the plate current. Then the voltage equations are

$$\left(R_1 + jpL_1 + \frac{1}{jpC_1} \right) I_1 + jpM_{12} I_2 + jpM_{1p} I_p = 0$$

$$\left(R_2 + jpL_2 + \frac{1}{jpC_2} \right) I_2 + jpM_{12} I_1 = 0$$

$$-\frac{I_1}{jpC_1} = \frac{I_p}{g}$$

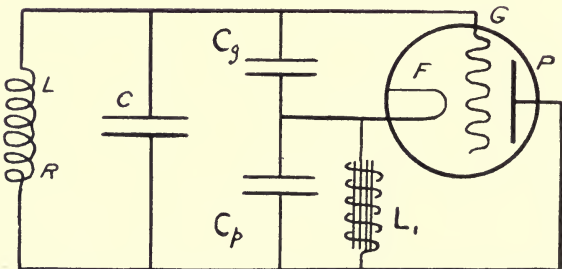

FIG. 100.—Scheme of Connections Equivalent to the Ultraudion of de Forest.

$$C^2 = C + \frac{C_p C_g}{C_p + C_g} \quad g = \frac{C^2 R}{L} \frac{(C_g + C_p)^2}{C_g C_p}$$

Eliminating I_1 , I_2 and I_p from these three equations and

separating real and imaginary parts we obtain the equations

$$(1 - p^2 C_1 L_1) (1 - p^2 C_2 L_2) - (p C_1 R_1 - p M_{1,2} g) p C_2 R_2 - p^4 C_1 C_2 M_{1,2}^2 = 0$$

$$(1 - p^2 C_1 L_1) C_2 R_2 + (1 - p^2 C_2 L_2) (C_1 R_1 - M_{1,2} g) = 0$$

If we eliminate $M_{1,2} g$ we obtain a cubic equation in p , showing that there are three possible frequencies of oscillation. If we tune the two oscillation circuits and make $C_1 L_1 = C_2 L_2$ we obtain for the value of g the equation

$$g = \frac{C_1 R_1 + C_2 R_2}{M_{1,2}}$$

Hazeltine has given (*loc. cit.*) a large number of schemes of connection in which two oscillatory circuits are intertwined and coupling effected by transformers or condensers. Two modes of connection for oscillation generation in a single circuit are delineated in Fig. 99 and Fig. 100. The value of g for each case is given under the diagram. The diagram Fig. 99 is equivalent to a mode of connection known as the "Western Electric" circuit, and Fig. 100 is equivalent to a scheme of connections which has been called by de Forest the "Ultraudion." In connection with this part of the subject the reader may be referred to a Paper by Captain E. V. L. Appleton, R.E., "A Note on the Production of Continuous Electrical Oscillations by the Three-Electrode Valve," in *The Electrician* for December 27th, 1918.

We shall return to the consideration of some of these thermionic circuits for oscillation generation in dealing in the next and following chapters on the thermionic detector as used for radiotelegraphic reception and radiotelephonic transmission.

CHAPTER V.

THE THERMIONIC DETECTOR IN RADIOTELEGRAPHY.

1. We have now to consider more in detail the various arrangements of circuits and methods of employing thermionic appliances in radiotelegraphic reception for the detection and amplification of the feeble electric oscillations set up by incident electromagnetic waves in the receiving aerial wires of a radiotelegraphic station.

One great advantage possessed by all the types of thermionic detector, whether Fleming valve or any subsequent three- or four-electrode development, is that these instruments are proof against any damage by atmospheric electric discharges or stray waves, which are the bugbear of the radiotelegraphist. The various kinds of crystal detector and the metallic filings coherer and electrolytic detector are liable to be put out of adjustment or rendered insensitive by such irregular or excessive discharges. One other type of detector—viz., the Marconi magnetic detector—shares with the thermionic devices this immunity.

Moreover, the thermionic detectors can be used to eliminate stray or violent vagrant waves in virtue of the fact that they are not only oscillation-detecting but current-limiting devices. As we have already shown, the operation of a gradually increasing voltage applied to a vacuous space, whether perfect vacuum or highly rarefied gas, by means of an incandescent cathode and cold metal anode is to bring the thermionic current up to a certain limiting or saturation value. Hence, such an instrument becomes a means of stopping out currents which exceed a certain strength.

The thermionic valve is therefore either an oscillation rectifying and detecting device, an oscillation producing or current amplifying instrument, or a current limiting appliance according to its construction and the way in which it

is used in receiving arrangements. Also, in virtue of its oscillation generating powers, it can be employed in the detection of continuous oscillations by methods called heterodyne or beat-reception as well as for the detection and amplification of trains of damped waves.

Furthermore, it is not only a qualitative detector, but a quantitative one, and its response bears a definite relation to the amplitude of the incident electric waves or to the strength of the oscillations in the receiving aerial, and therefore it can be used in radiotelephony. We shall accordingly consider here its practical use in these various capacities.

2. In its original two-electrode form, comprising one incandescent cathode and one cold metallic anode, it can rectify electric oscillations, and therefore detect trains of electric oscillations arriving at intervals of time comparable with audio-frequency by converting them into gushes of unidirectional electric current, which are therefore capable of affecting a telephone receiver.

The impedance of an ordinary Bell receiving telephone is much too large to pass any sensible current under electromotive forces reversed several hundred thousand times a second, and, even if it could, the inertia of the telephone diaphragm is too great to permit it to respond. Also the human ear is not sensitive to aerial vibrations of greater frequency than about 20,000 per second as sound. Hence, electric oscillations *per se* cannot affect the telephone *plus* human ear combination directly. If, however, these oscillations come in damped intermittent trains having a train- or audio-frequency of anything between 100 and 1,000 per second, and if these groups of oscillations are rectified by inserting a thermionic valve in series with the telephone, then the telephone is traversed by gushes of electricity which have a frequency suitable for affecting it and the ear, and can create sound signals. The simplest application of the two-electrode thermionic valve is, therefore, to connect one terminal of a high-resistance telephone (2,000 to 4,000 ohms) to one terminal of the condenser in the closed receiving oscillation circuit, and to connect the other terminal to the hot cathode or filament of a Fleming oscillation valve the cold anode or plate of which is connected to the second terminal of the receiving condenser.

THE THERMIONIC VALVE IN

The physical action is then as follows: When electric waves strike the aerial, *A*, they set up oscillations in the closed condenser circuit, *L, C* (see Fig. 101). The terminals of the condenser would then become electrified alternately *plus* and *minus*, but if the anode of the valve, *P*, is connected to one condenser terminal, then when this becomes positively electrified it is instantly discharged by the negative electrons emitted by the hot cathode, *F*. If it is negatively charged it is unaffected. The vacuous space between the cathode and anode may therefore be regarded as having an infinite resistance to electric current tending to flow (in the usual

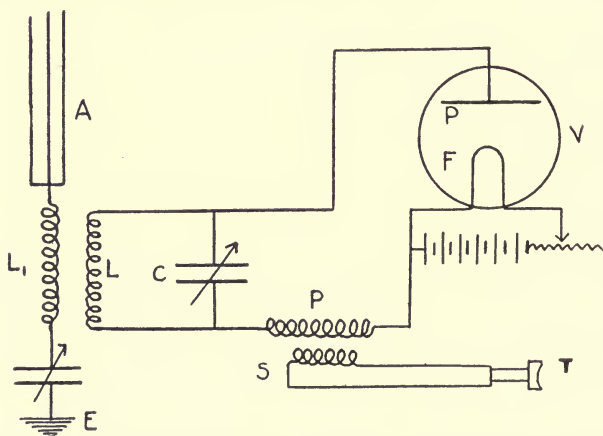

FIG. 101.—CONNECTIONS FOR USE OF FLEMING VALVE AS A SIMPLE RECTIFIER DETECTOR IN A RADIOTELEGRAPHIC RECEIVER.

A, Aerial. L₁, L, Jigger. C, Tuning Condenser. V, Valve. F, Incandescent Filament. P, S, Telephone Transformer. T, Telephone Receiver.

sense) from the filament to the plate, but a finite and not very high resistance for current in the opposite direction. Hence, if a high-resistance telephone receiver is connected in series with the thermionic valve, and the two placed as a shunt across the condenser in the receiver circuit, at each spark discharge at the transmitter a rectified train of oscillations or a simple unidirectional but pulsating flow of electricity passes through the telephone. If the sparks succeed each other at regular audio-frequency, the sounds created in the telephone run together into a musical note,

and this can be cut up into Morse code signals by manipulating the key in the transmitter circuits. The two-electrode or Fleming valve, with filament rendered incandescent by a 4-volt storage battery of 2 cells associated with a high-resistance head telephone, constitutes a simple, very efficient, and much-used type of radiotelegraphic signal receiver for short or moderately long-distance work. In addition to its use as a simple rectifier of oscillations, which function can be performed either by an extremely high-vacuum bulb or by a moderately high-vacuum valve, there is a second mode of use as a detector, which depends upon the fact that in valves of not extremely high vacuum the characteristic curve may have somewhat sudden changes of curvature at certain points. In general, this is due to the commencement of gaseous ionisation at some potential difference of cathode and anode resulting in a marked and rather sudden increase in thermionic current.

We have already explained in Chapter II. this mode of use which consists in applying a certain D.C. boosting voltage in the external circuit connecting the cathode and anode. If, then, an alternating electromotive force is superimposed by inserting in the same circuit an oscillation transformer, the mean value of the current may be greater than when this latter E.M.F. is not superposed. Hence the result is an increase of current through the telephone, which may be greater than that due to the simple rectification of the alternating current taken by itself if the change of curvature in the characteristic is sufficiently great.

In certain valves prepared by the author this method of using them gave a great increase of sensibility, but it was not found possible to repeat in manufacture with any certainty a valve having a particular form of characteristic which depends upon special conditions of ionisation of the residual gas in the bulb at a certain exact pressure.

3. In the case of the three-electrode valve it may be used either as a simple detector or as an amplifier of radio- or audio-frequency.

In the first case some form of connection must be employed, such that the alternating current forming a group of oscillations of high frequency is converted into a single wave of current through the telephone.

The usual method is to make use of the valve action

THE THERMIONIC VALVE IN

between the filament and grid to charge a small condenser, C_1 , called a stopping condenser, which is inserted between the grid and the condenser, C , in the closed oscillation receiving circuit. (See Fig. 102.)

At each train of oscillations this stopping condenser becomes negatively charged on the side connected to the grid. The emission of negative electrons or ions from the incandescent filament bestows on the space between filament and grid a unilateral conductivity. Hence the oscillations are rectified. This action is identical with that in the simple two-electrode valve. The negative charge on the grid then

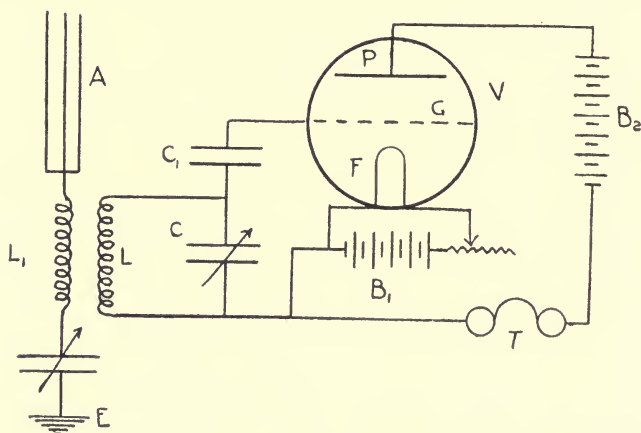

FIG. 102.—CONNECTIONS FOR USE OF A THREE-ELECTRODE VALVE AS A DETECTOR IN A RADIOTELEGRAPHIC RECEIVER.

A, Aerial. L_1 , L, Jigger. C, Tuning Condenser. C_1 , Stopping Condenser. V, Valve. B_1 , Valve Battery. B_2 , Boosting Battery. T, Head Telephone Receiver.

suddenly reduces the plate-filament current due to the boosting battery, B_2 , and this creates a sound in the telephone. The negative charge on the grid then leaks away, and to aid this leakage the insulation of the stopping condenser should not be too good. The process then repeats itself at each train of oscillations. If the valve is worked at a suitable point on the characteristic curve and the boosting voltage in the plate circuit properly adjusted the sound in the telephone may be louder than if the simple rectified oscillations are passed through it, and hence an

advantage gained by the use of the three-electrode form of valve. The degree of amplification is, however, a rather uncertain quantity and depends to a large extent on the precise point on the characteristic curve at which the filament-plate circuit is adjusted. It also depends on the degree of additional gas ionisation which may occur at this point. Hence, when using not very highly exhausted three-electrode valves there will in general be great differences in the amount of current amplification or loudness of the telephone sounds for given constant received signal currents in the aerial wire.

In high-vacuum valves these differences do not exist and more constant results are obtained; but then there are modes of connection making use of reaction between the grid and plate circuits which give better results than the simple "valve" use as above described.

We have already in Chapter III. pointed out that there is a second mode, described by E. H. Armstrong, of using the three-electrode valve quite analogous to the author's second method of using his two-electrode valve, which depends upon working at a particular point in the characteristic curve of the grid-filament circuit. In this latter method, in addition to the filament-heating battery and battery in the plate circuit, we make use of a third battery with potentiometer shunt, as shown in Fig. 61, Chapter III., and thereby apply to the filament and grid a potential difference which corresponds to a point of change of curvature on the characteristic curve near the place where it bends over horizontally either above or below the point of symmetry. If, then, an alternating electromotive force is superimposed by the receiving circuits on this steady E.M.P. there is a sudden increase or decrease in the current flowing in the filament-grid circuit, due to the same action as in the case of the two-electrode valve when used in the author's second mode. This increase or decrease in the filament-grid circuit is accompanied by a sudden increase or decrease in the current in the plate-filament circuit. If the telephone is shunted by a condenser, C_1 (see Fig. 61, Chapter III.), this latter becomes charged and the charge leaks away through the telephone, thus creating a momentary increase or decrease of the telephone current and therefore a sound in the telephone, the frequency of

which is that of the spark or discharger in the transmitter.

With regard to the connection of the telephone it may be remarked in passing that it is generally advisable to connect the telephone inductively with the plate circuit and not to insert the telephone directly in the plate circuit, where its high impedance will throttle the current variations in and reduce the strength of the plate current unless the telephone is shunted by a condenser.

Generally speaking this "valve" use of the three-electrode valve does not give better results in reception than can be obtained by a good two-electrode or Fleming valve or a well adjusted crystal rectifier.

4. A very large number of modes of use of the three-electrode thermion have, however, been devised in which it is made to act as an amplifier of oscillations, and in combination with some form of crystal electrolytic rectifier or simple rectifying two-electrode valve is thereby employed to build up a receiving arrangement of great sensitiveness to high-frequency oscillations.

As already explained in Chapter III., we may in this operation amplify the high-frequency oscillations themselves, which is usually called radio-amplification, or else we may magnify the rectified gushes or unidirectional flow of electricity corresponding to such train of damped oscillations. This latter process is called audio-amplification. Finally, we may combine together the two magnifications. In cases in which we are dealing with radio-amplification the oscillation transformers used in circuits must be air-core, and condensers need generally to be only of small capacity and may be variable capacity air condensers. In those circuits in which currents of audio-frequency are circulating transformers with iron cores and condensers with oil or ebonite or mica dielectrics can be employed, as in those cases the tuning generally requires large inductances or capacities.

In connection with these methods of amplification the function of the three-electrode valve is to create in the plate circuit variations of a current which repeat or reproduce variations in the potential of the grid. Since the capacity of the grid and wires connected thereto is generally small the energy required to make a considerable variation in grid potential is small. Nevertheless the corresponding

changes in plate current may convey to some signal-making instrument, such as a crystal rectifier and telephone, a very much larger amount of energy in virtue of the relay action of the thermion in releasing energy from the plate circuit battery.

The simplest method of radio-amplification is therefore to connect the grid and filament of the thermionic valve to the terminals of the tuning condenser in the closed receiver circuit. The plate of the condenser connected to the grid then becomes alternately charged + and -. The grid

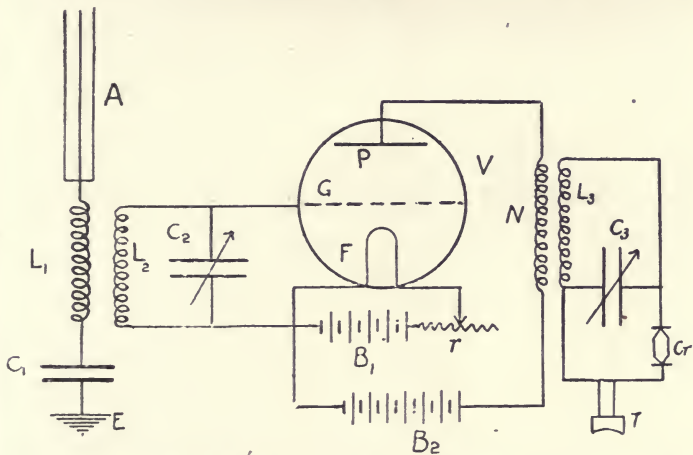

FIG. 103.—CONNECTIONS FOR USE OF A THREE-ELECTRODE VALVE AS AN AMPLIFYING RELAY TO OPERATE A CRYSTAL OR OTHER DETECTOR.

C₂, Crystal Detector. T, Telephone Receiver. B₁, Filament Heating Battery. B₂, Boosting Battery. NL₃, Jigger coupling Circuit L₃ C₃ to the Plate Circuit.

therefore is alternately raised and lowered in potential and creates in the plate current an increase or diminution which is equivalent to superimposing an alternating high-frequency current upon the steady D.C. plate current. This alternating part of the current can be transferred by an oscillation transformer to a tuned oscillation or flywheel circuit and to the terminals of the condenser in this circuit a crystal detector such as a carborundum crystal or a contact of zincite and chalcopyrite in series with a high resistance Bell telephone can be connected. (See Fig. 103.) The crystal then

gets the benefit of the augmented power drawn from the battery, B_2 , in the plate circuit, and the arrangement constitutes a crystal detector operated through a thermionic relay instead of directly by the received oscillations of small power.

Another typical mode of connection is shown in the diagram in Fig. 104 taken from a British specification No. 8,821 of 1913.¹

In this mode of connection a battery is shown inserted in the grid circuit, but the usual tuning condenser is omitted.

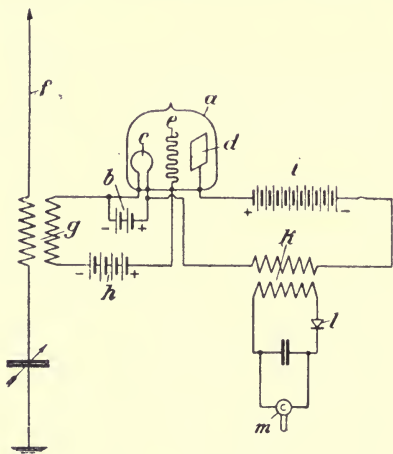

FIG. 104.—CONNECTIONS FOR USE OF A THREE-ELECTRODE VALVE AS AN AMPLIFYING RELAY ON A CRYSTAL DETECTOR.

l , Crystal Detector. m , Telephone Receiver.
 R , Coupling Transformer. a , Three-electrode Valve.

detector, l , and a telephone, m , as a shunt to the condenser in the crystal circuit. The rectifying detector, l , may be replaced by a Marconi magnetic detector if necessary.

The degree of magnification obtained by the use of the thermionic relay depends to some extent upon the vacuum in the bulb. With very high vacua a current amplification

¹ Application by the Wireless Telegraph Company of Berlin. This arrangement is probably due to A. Meissner, but no name of a personal inventor is given in the specification.

of 1 to 4 or 5 may be obtained, but with lower vacuum or soft bulbs in which gaseous ionisation takes place a higher magnification of 1 to 10 or thereabouts is obtainable. This refers, of course, to a single thermion without use of the reaction coupling between grid and plate circuits.

5. An important improvement on the above simple relay method of using the thermion was introduced by Lieut. C. S. Franklin in 1913,¹ who availed himself of the property of the three-electrode valve of generating oscillatory energy as follows :

Franklin coupled together the grid and plate circuits, as shown in Fig. 105, by a transformer, *mn*, the coils of which could be separated so as to vary the mutual inductance. If the coupling is too close, then, as shown in the previous chapter, the thermion will generate oscillations.

There is, however, a certain limiting value of the coupling beyond which the oscillations are not produced or sustained. The arrangement then stands ready to oscillate when the smallest impulse is given to it by incoming energy from the aerial wire. The feeble incoming electric vibrations have energy added to them derived, of course, ultimately from the battery in the plate circuit, and the energy not only acts to annul the damping of the received signal oscillations by the resistance of the circuit, but even more than neutralises it and imparts what may be called a negative decrement to the receiving circuits. The so sustained and amplified oscillations

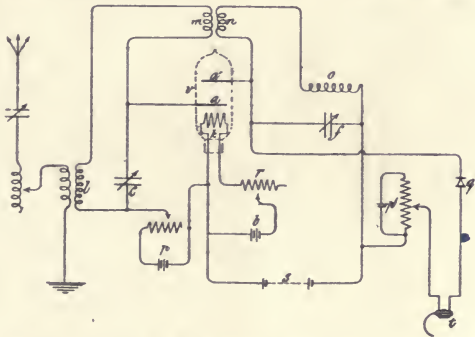

FIG. 105.—C. S. Franklin's method of using a Three-electrode Valve with Grid and Plate Circuit Inductively Coupled by a Transformer, *mn* to act as an Amplifying Relay on a Crystal Detector. *q*.

are not produced or sustained. The arrangement then stands ready to oscillate when the smallest impulse is given to it by incoming energy from the aerial wire. The feeble incoming electric vibrations have energy added to them derived, of course, ultimately from the battery in the plate circuit, and the energy not only acts to annul the damping of the received signal oscillations by the resistance of the circuit, but even more than neutralises it and imparts what may be called a negative decrement to the receiving circuits. The so sustained and amplified oscillations

¹ See British Patent Specification No. 13,636 of June 12th, 1913, filed by Marconi's Wireless Telegraph Company, Limited, and C. S. Franklin.

THE THERMIONIC VALVE IN

tions are then made to act on a crystal or other rectifying detector, q (see Fig. 105), placed in series with a telephone receiver, t . A battery, with terminals connected by a potential dividing resistance, p^1 , is employed in series with the telephone and crystal rectifier so as to operate at the most favourable point on the characteristic of the said rectifier.

A number of somewhat similar arrangements were subsequently patented by Von Arco and A. Meissner in 1914 (British Patent Specification No. 252, of January 5th, 1914).

One of their schemes of connection is shown in Fig. 106, in

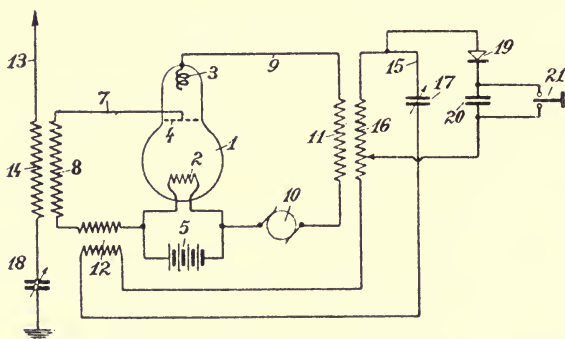

FIG. 106.—Connections for use of a Lieben-Reisz Thermionic Relay to Operate a Crystal Detector as a Radiotelegraphic Receiver. (Von Arco and A. Meissner.)

which the Lieben gas relay is employed as the thermionic valve.

It will be seen that the grid 4 of the valve is caused to oscillate in potential by the oscillations in the aerial wire 13 transferred to it by the transformer 14-8. This creates oscillations of current in the plate circuit 9-10-11, in which the D.C. dynamo 10 provides the steady E.M.F. The plate circuit is coupled to the grid circuit through the closed oscillatory circuit 12-16-15-17 by the two transformers 11-16 and 12. The crystal detector 19, in series with a telephone 21, is placed as a shunt across the secondary coil of the transformer 16. The various circuits are tuned by the variable condensers and inductances to the frequency of the incoming waves. The oscillations set up in the closed

circuit 12-16-15-17 by the aerial wave oscillations acting through the transformer 12 are strengthened by the inductive action of the oscillations in the plate circuit 3-9-11-10, which latter are themselves reinforced by the reaction of the plate and grid circuits taking place through the closed detector circuit 12-16-15-17, which acts in this case as a flywheel circuit.

Some useful practical information as to the management of such amplifying valve detector circuits was given in an article on the three-electrode valve published in *The Wireless*

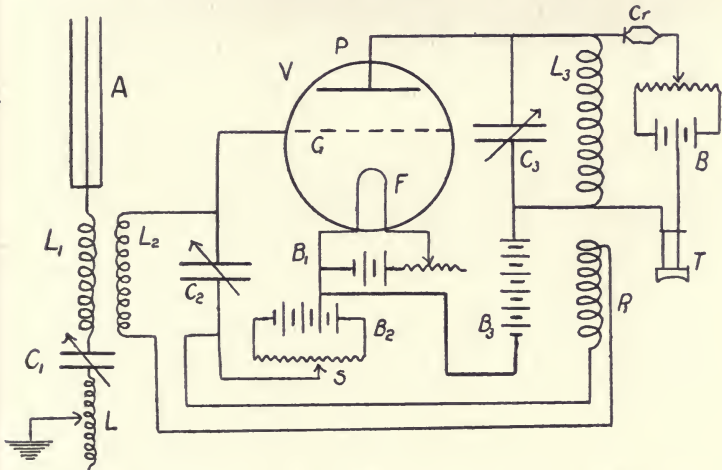

FIG. 107.—Connections for use of a Three-electrode Valve as an Amplifying Relay in Conjunction with a Crystal Detector, Cr, and Telephone. T.

World for June, 1917, which we reproduce here by permission.

The scheme of circuits is shown in Fig. 107. It will be seen that the aerial, *A*, has a tuning coil, L_1 , and a variable capacity, C_1 in series with it, and also the primary circuit, L_1 , of an oscillation transformer. The secondary circuit, L_2 , is in series with another coil, R , which is in mutual inductance with an inductance, L_3 , in the plate circuit of the valve. In the secondary circuit the variable condenser, C_2 , completes an oscillation circuit, which is tuned to the aerial. The filament of the valve is generally made to be incandescent by a 4- to 6-volt battery, B_1 , with rheostat in

THE THERMIONIC VALVE IN

series. The condenser circuit, $L_2 C_2$, is connected to the grid, G , of the valve and to the filament through a battery, B_2 , of 10 to 12 volts, closed by a rheostat, S , serving as a potentiometer wire. The function of this battery is to create a difference of potential between the filament and grid of required amount. The plate, P , is connected through an oscillation circuit, $L_3 C_3$, with the plate battery, B_3 . This battery has its negative pole in connection with the filament. Across the terminals of the inductance, L_3 , is connected a crystal, Cr (carborundum), detector in series with a battery of a couple of cells short-circuited by a potentiometer wire. The telephone, T , is in series with this battery. The coil, R , in the grid circuit is coupled inductively to L_3 , and this coupling can be varied. It should be fairly loose. There is a certain degree of coupling which is best. If it is too close the valve circuits set up a self-sustained oscillation and a howling noise is heard in the telephone. The coupling of R and L_3 must then be reduced until this noise just ceases. There are three tunings to be performed.

(1) The aerial has to be tuned to the incoming wavelength by the variable capacity C_1 and inductance L_1 ; (2) the oscillatory circuit, $C_2 L_2$, connected to the grid has to be tuned to the aerial; (3) the plate circuit, $C_3 L_3$, has to be equally tuned; and (4) the coupling of R and L_3 has to be adjusted so that any continuous sound in the telephone is stopped. The character of this noise, when the coupling of R and L_3 is a little too close, affords a valuable means of correcting other adjustments. If the noise is very high pitched or shrill the crystal potentiometer contact should be moved away from the centre so as to increase the applied E.M.F. in the crystal circuit. If the noise is very low pitched, more like a succession of clicks, the contact should be moved in the opposite direction. As regards the valve grid potentiometer (battery B_2), we adjust as follows: Set the coupling of the reaction coil R and L_3 so that the noise in the telephone just disappears. Then vary the position of the slider on rheostat S until this noise reappears or is loudest, and this is the correct setting for the valve potentiometer. If the valve used is a "soft" one or one not having a very high vacuum, then the best effects are obtained by working at a particular point on the charac-

teristic. The plate voltage used with such soft valves is generally 20 to 40 volts or so, whereas with "hard" or high-vacuum valves an E.M.F. of 100 volts may be used with advantage in the plate circuit. In soft valves if too high a plate voltage is used a blue glow appears in the valve, due to gas ionisation. The correct plate voltage can be found by sliding the valve potentiometer right to one end so as to make the grid as positive as possible and then increasing the plate voltage step by step until a faint glow can be seen in the valve in the dark. In the case of valves provided with a vacuum-reducing side tube containing a pellet of asbestos or some material which evolves gas or

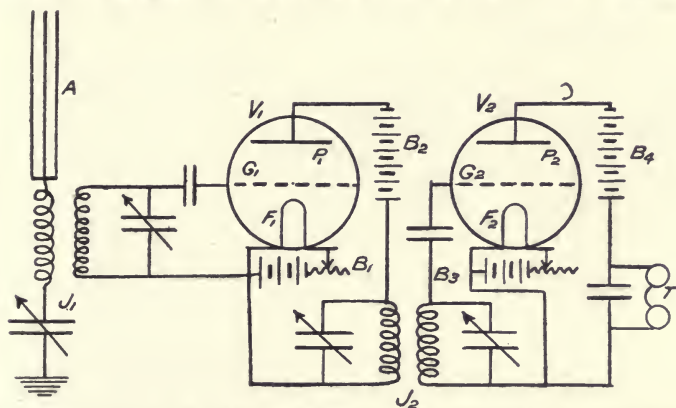

FIG. 108.—Connections for use of two Three-electrode Valves in Cascade as Amplifying Detector. The Plate Circuit of the Valve, V_1 , is coupled to the Grid Circuit of Valve, V_2 , by the transformer, J_2 . T is the Telephone Receiver in Plate Circuit of Valve V_2 .

slight heating, the operator has it in his power to adjust the vacuum within certain limits. Generally speaking, better results can be obtained by the skilful use and adjustment of soft valves than with very hard ones; but the hard valves are most constant and easier to manipulate. In the use of any form of valve it is important not to overrun the filament by applying too much E.M.F. in the filament-heating battery, as this greatly shortens the life of the valve. Experience alone shows at what brightness the filament should be worked. With tungsten filaments it is equivalent to about 1.25 watts per candle-power; with carbon filaments, not much under 3 watts per candle-power is admissible.

THE THERMIONIC VALVE IN

As regards telephones it is best with valve receivers to use low resistance telephones coupled, as in Fig. 3, by a transformer to the crystal circuit.

6. When greater magnification is required than can be obtained with a single thermionic relay we can resort to the method of cascade working in which two or more such relays are joined in series and in each individual relay we may or may not apply the reaction principle by coupling the grid and plate circuits.

In the case of the simple cascade the plate circuit of the first valve is inductively coupled to the grid circuit of the second valve, as in Fig. 108, which represents two

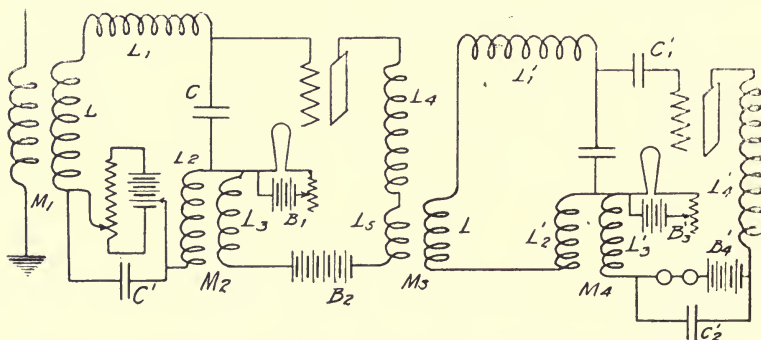

FIG. 109.—Connections of E. H. Armstrong for use of two Three-electrode Valves in Cascade combined with the Self Re-enforcement of each Valve. (N.B.—The bulb of each valve is not shown in the diagram.) M_3 is the Cascade Coupling Transformer, and M_2, M_4 the Re-enforcement Transformers.

high-vacuum three-electrode thermionic amplifiers in cascade.

In the small pliotron, described in Chapter III., an increase in potential of the grid by 1 volt increases the plate current by 1 milliampere, and with suitable arrangements the current amplification can be made 1 to 100 for a single instrument. Hence, with two in cascade the multiplying power may be as much as 10,000.

By combining with the cascade arrangement the reaction principle in each thermionic relay very large amplifying power may be obtained, but when working with spark transmitters careful adjustment is then necessary to prevent either thermion from starting oscillations on its own account.

An arrangement of high magnifying power for the reception of spark signals is given by E. H. Armstrong in the paper already mentioned. It is shown in Fig. 109. In this it will be seen that the two thermionic relays are coupled through the transformer M_3 and that in each the grid and plate circuits are coupled by the reaction transformers M_2 and M_4 .

The arrangement, however, requires some skill in setting up to avoid causing one or both of the systems to start generating oscillations.

The first system should be brought nearly up to the point

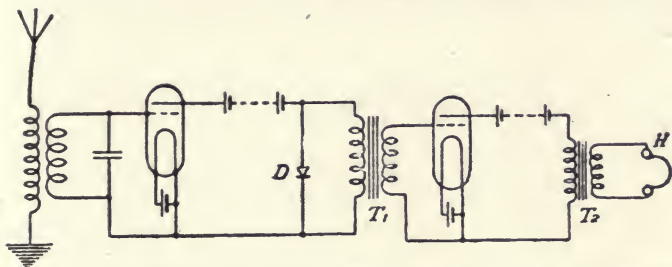

FIG. 110.—TWO THREE-ELECTRODE VALVES IN CASCADE, THE FIRST GIVING RADIO-AMPLIFICATION AND THE SECOND AUDIO-AMPLIFICATION.

D is the Crystal Detector and H the Head Telephone Receiver.

of oscillation generation by increasing carefully the closeness of the coupling of transformer M_2 . Then when the same is done for the second system at M_4 it will be found that the second system absorbs energy from the first, and the coupling of M_2 can be made a little closer without setting up a continuous sound in the telephone. By careful adjustment of all three couplings, M_2 , M_3 , and M_4 , it is possible to obtain an amplification of about 1,000 times with very sharp tuning.

We have already mentioned in Chapter III. that by the use of coupling transformers with iron cores we can amplify the currents of audio-frequency and we can operate two three-electrode thermionic relays in cascade, one of which amplifies the radio-currents and the second the audio-currents as shown in the diagram in Fig. 110.

7. We must next pass on to consider the use of the three-electrode thermion in the detection of continuous or

THE THERMIONIC VALVE IN

undamped oscillations and electric waves. This depends essentially upon the power to produce electric oscillations and hence to create what are known as "electric beats."

It is a broad general principle that when two sets of vibrations of any kind having slightly different frequency commingle at one place in a medium the amplitude of the resultant oscillations increases and decreases in a periodic manner, creating what are called "beats" in acoustics. The total number of beats per second is equal to the difference between the numbers representing the frequencies of each vibration separately.

The rough proof of this theorem is as follows. Let the displacement due to one set of vibrations be represented by d at any instant t and let that of the other be d^1 . Let D and D^1 be the maximum displacements respectively. Then if the displacement follows a sine law we can write

$d = D \sin \frac{2\pi}{T}t$. Where T is the periodic time, and also

$d^1 = D^1 \sin \left(\frac{2\pi}{T^1}t + \theta \right)$ where θ is an angle of phase difference.

Let $2\pi/T = n$ and $2\pi/T^1 = n^1$ where n and n^1 are the respective frequencies. For the sake of simplicity we shall consider the phase difference θ as non-existent. Then the total or resultant displacement when both vibrations are superimposed is $d + d^1 = D \sin 2\pi nt + D^1 \sin 2\pi n^1 t$.

Suppose, then, that D is very nearly equal to D^1 and n to n^1 .

We can then, by a well-known trigonometrical theorem, write :

$$d + d^1 = \left[2D \cos 2\pi \frac{n - n^1}{2} t \right] \sin 2\pi nt.$$

Hence we see that the maximum amplitude is periodic and equal to $2D \cos 2\pi \frac{n - n^1}{2} t$. The frequency or number of complete periods in this periodic variation of the amplitude is $(n - n^1)/2$. But this implies that the number of maximum amplitudes or beats per second is $n - n^1$, since a maximum amplitude occurs each half period of the beat. The number of beats is therefore $n - n^1$. If therefore a graphic representation is made of the result of adding two simple periodic curves of slightly different wave-length or

frequency we should obtain a curve of varying amplitude, as in Fig. 111.

Suppose, then, that two simple periodic currents are passed through a Bell telephone, and let one of these currents have a frequency n and the other n^1 we should hear in the telephone a periodic waxing and waning in the sound, these maxima or beats coming with a frequency $n - n^1$ provided n and n^1 are not very different.

Upon this fact a method of detecting continuous high frequency oscillations is founded. Let us suppose that in an aerial there are high frequency continuous oscillations of frequency n ; we could not by any of the ordinary spark or

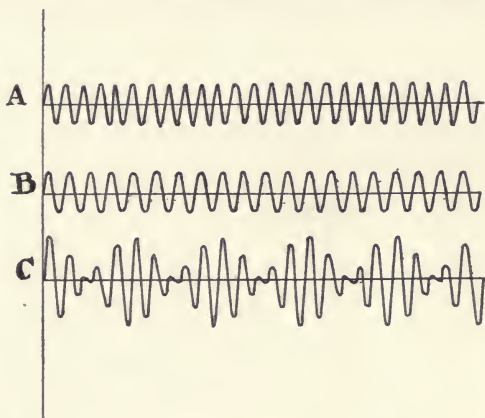

FIG. 111.—Addition of two Periodic Curves, A and B, of slightly different Wave Length, giving a Compound Periodic Curve, C, showing "Beats" or Variations in Amplitude.

above-described methods of reception detect them, because these methods essentially depend upon the existence of a regular series of interruptions or intermittencies in the train of waves.

Suppose, then, that we create in the aerial wire by local means continuous oscillations differing slightly in frequency from those created by the incident signal waves. The result will be to create a series of electrical "beats" in the aerial having a frequency equal to the difference between the frequency of the arriving and locally produced oscillations.

If this difference is such that it gives a beat frequency of suitable audio-frequency—viz., something like 100 to 1,000

beats per second—we can detect these by the ear applied to the telephone by the steady musical sound they cause therein.

Accordingly this method of detection of continuous electric oscillations requires the possession of means for creating undamped oscillations of nearly the same frequency. When this method of reception was first introduced by R. A. Fessenden and applied by him in radiotelegraphic reception he used a high frequency alternator. But such an appliance for producing oscillations of radiotelegraphic frequency is expensive and not easy to obtain. Accordingly the method never came into much use until the discovery of the fact that a three-electrode thermion could be used as a generator of electric oscillations of radiotelegraphic frequency. This discovery gave a fresh impetus to the method of "beat" or heterodyne reception by providing a cheap, easily made and managed means of generating the required high frequency oscillations.

8. Based on the above-mentioned principles methods of reception for continuous waves have been devised which depend upon the fact that we can employ a three-electrode thermion in conjunction with certain circuits to produce undamped oscillations of a slightly different frequency from those of the aerial oscillations due to the incident waves and can combine in the thermion circuits these two sets of electric oscillations so that the telephone is actuated by the resulting beats. The frequency of the generated oscillations can be so adjusted that we obtain, say, 500 beats per second which give rise to a musical sound of rather high pitch in the telephone. If, then, the production of the signal waves is controlled by a key in the transmitter so as to start and stop these incident waves in accordance with Morse signals the sounds due to the "beats" follow the same course and repeat in the telephone audibly the same signals. This is called beat-reception or heterodyne reception.

The following arrangement, due to Capt. H. J. Round, of Marconi's Wireless Telegraph Company, is a good example of the application of this principle.

The aerial wire is coupled through an oscillation transformer with a condenser of variable capacity so as to tune the closed circuit marked *a* (see Fig. 112) to the aerial. One terminal of this condenser is connected to the filament and

the other to the grid of a three-electrode valve. The plate circuit containing the battery is also connected to an oscillation circuit *e*. This circuit also contains a telephone receiver, which should properly be shown with a condenser across its terminals, or else be placed in a circuit inductively coupled to the plate circuit.

The plate circuit is tuned to a slightly different frequency from that of the incoming waves. The two inductance coils in the plate and grid circuits *e* and *a* are also placed so as to have mutual inductance. Accordingly in the absence of any current in the aerial wire the thermion system would generate oscillations of frequency n_1 provided the coupling of the two coils is close.

If, however, oscillations of frequency n are produced by arriving waves in the aerial these oscillations will be forced upon the plate circuit and the result will be to produce in it beats of frequency $n - n_1$. By suitable selection of capacities and inductances in the circuits the difference $n - n_1$ may be made equal, say, to 500 or 600 and produces in the telephone a high musical note which is cut up into Morse code signals by manipulation of the key in the transmitter circuit, because arresting the oscillations in the receiving circuit due to the incident waves at once stops the "beats."

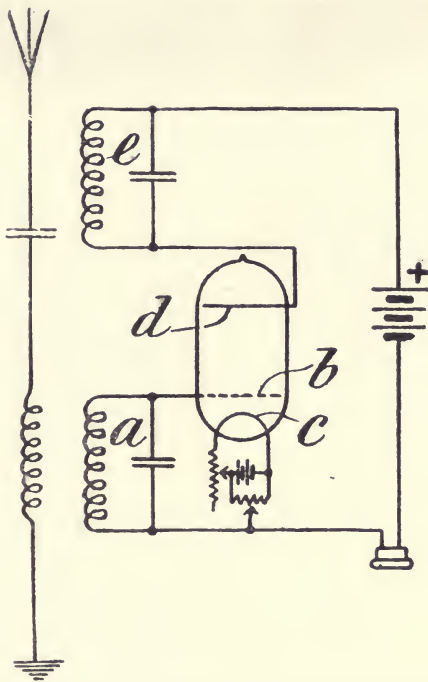

FIG. 112.—H. J. Round's Connections for use of a Three-electrode Valve for Beat Reception.

It has been pointed out by Mr. E. H. Armstrong that one of the important advantages of the thermionic valve when used for beat reception is that the resultant or beat current is of nearly pure sine wave form. Hence we can amplify it by resonance and proper tuning of the telephone circuit.

This cannot be done with spark systems of transmission, at least not nearly so well, on account of the production of more distorted waves.

Hence, in continuous wave reception we can apply audio-tuning so as to give a very sharp resonance in the telephone circuit. In Figs. 113 and 114 two sets of connections for

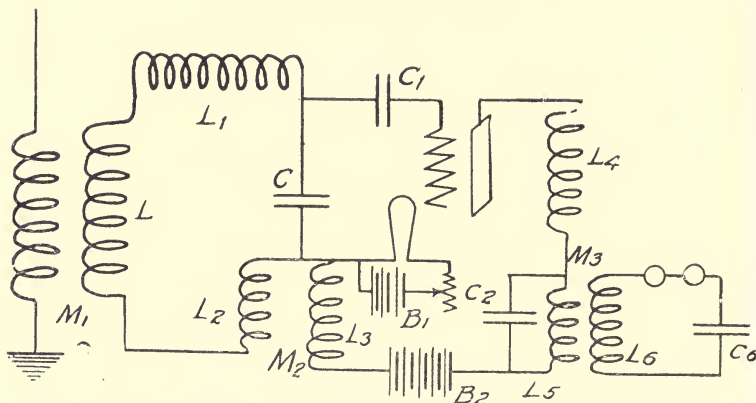

FIG. 113.—Connections of Circuits of Three-electrode Valve for Reception and Detection of Undamped Waves. (E. H. Armstrong.)

such tuning are shown, taken from the paper by Armstrong already quoted.¹

In Fig. 113 the telephone is shown inserted in an oscillation circuit, L_6C_6 , which must be tuned to the beat frequency.

In Fig. 114 are shown two three-electrode valves in cascade in which the first thermionic valve system is coupled to a second by the transformer M_3 , and the telephone is placed in the plate circuit of the latter. The first thermion has its grid and plate circuits coupled for re-enforcement.

To show the degree of sharpness of tuning, consider incident waves having a frequency of 50,000, and let the first thermionic system be tuned for 49,000. Then the beat

¹ See *Proceedings of the Institute of Radio Engineers*, vol. iii., p. 228, September, 1915.

THE THERMIONIC VALVE IN

it is coupled, which have a frequency differing from that of the incoming waves by a number which falls within good audio-frequency. Thus if the incoming or incident waves have a wave-length of 20,000 ft., or 50,000 frequency, then the generating thermion may be set to produce oscillations of 49,500 or 50,500 frequency.

The left-hand thermion system, coupled to the antenna, is an ordinary regenerative or retroactive receiving system, with coupled grid and plate circuits and telephone inserted in the plate circuit or coupled to it. This receiving set is

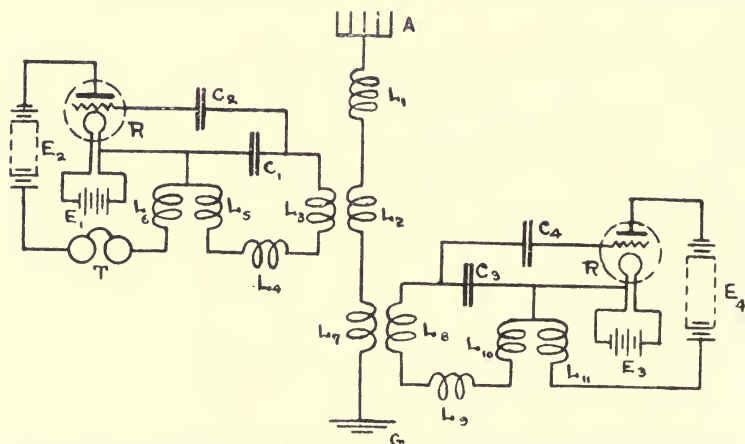

FIG. 115.—Heterodyne Method of Reception for Undamped Waves Employing a Three-electrode Valve to Produce the Local Oscillations required for "Beating" with the Incoming Oscillations. (J. J. Hogan.)

then acted upon simultaneously by the antenna oscillations set up by the incident waves and by those created by the generating thermion. Hence, beats will be produced in the telephone having a beat frequency equal to the difference of the two oscillation frequencies.

A somewhat simpler and more generally used method of heterodyne reception is to couple the aerial to a crystal receiving circuit arranged as in spark radio reception (see Fig. 116). In addition, the aerial is also coupled inductively, or, which comes to the same thing, the crystal receiving circuit is coupled inductively to a thermionic generator or three-electrode valve having its grid and plate circuits reactively coupled so as to generate oscillations of a fre-

quency differing from that of the incoming continuous waves by an amount equal to 500 or 1,000, or some suitable audio-frequency.

The result is to generate in the crystal receiving circuits groups of oscillations or beats of audio-frequency.

Thus, supposing the frequency of the incoming waves is 100,000, and the thermionic generator is tuned to produce oscillations of 99,500, we shall have produced in the crystal circuit beats of a frequency of 500. It will be seen at once that this method gives great selectivity. For suppose that some other station sends out waves differing only by 1 per cent.—viz., a frequency of 101,000—the result will be to produce

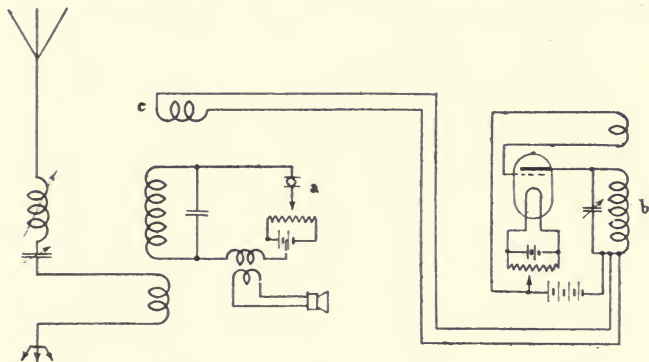

FIG. 116.—Arrangement of Circuits using a Three-electrode Valve for Production of Undamped Oscillations and Crystal Detector System for Detection of Beat Frequency Oscillations in a Heterodyne Receiver System for Undamped Wave Reception.

beats of 1,500 instead of 500, and these quarter beats would give rise to a shriller sound, three octaves in pitch above the beats of 500 frequency, and the jamming signals would therefore be easily distinguished from the signals to be received by the higher pitch. In practice the coupling between the thermionic generator circuits and the crystal receiving circuits should be kept quite loose.

The following practical hints in the manipulation of these heterodyne circuits have been given in an article in *The Wireless World* for July, 1917. If the tuning condenser of the thermionic oscillator is slowly turned, a characteristic "swish," produced by interference with atmospherics, will be heard as the tune passes that of the receiver. This swish

THE THERMIONIC VALVE IN

is a good indication in the absence of signals that all is well. It is advisable to keep moving the condenser round about the point where the swish is obtained until the station required is picked up, when it can be adjusted to such a point that a good reading note is obtained. It should be noted that the adjustments of the tune of the crystal receiver only affect the strength of the signal, whereas adjustments of the tune of the oscillator alter its pitch or note without affecting its strength.

There is no absolute necessity for a separate receiving and oscillation circuit. The same thermionic valve can be made to operate as receiver and oscillator, and the telephone placed in the plate circuit will be affected by the beats produced. Thus the aerial can be coupled to the grid

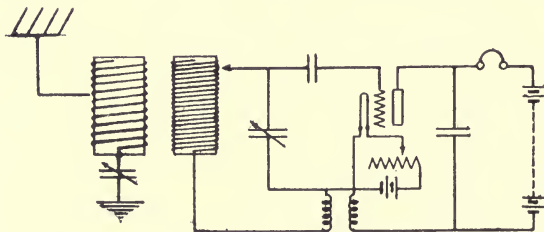

FIG. 117A.—Arrangement of Circuits for Using a Single Three-electrode Valve (bulb not shown) for Heterodyne Reception of Undamped Waves.

circuit of a three-electrode valve, with the usual stopping condenser inserted (see Fig. 117a), and with one coil of an oscillation transformer inserted in the grid circuit, as in the Armstrong regenerative connection. The plate circuit contains the usual boosting battery, telephone, and an adjustable condenser, also the second coil of the oscillation transformer. The coupling of this transformer must be sufficiently close to generate oscillations in the plate circuit by reaction with the grid circuit. The tuning of the plate circuit must be such as to give a frequency differing from that of the incoming waves by an amount equal to some suitable audio-frequency. The thermionic circuits then perform two functions: they create in the plate circuit, and, therefore, in the telephone, oscillations of the same frequency as those in the aerial by the valve and amplifying action already explained. They also generate oscillations of

RADIOTELEGRAPHY AND TELEPHONY

a slightly different frequency, and the beats produced by these two sets of oscillations produce in the telephone sounds of audio-frequency, which are cut up into Morse code signals when the key in the transmitter is manipulated. A slight

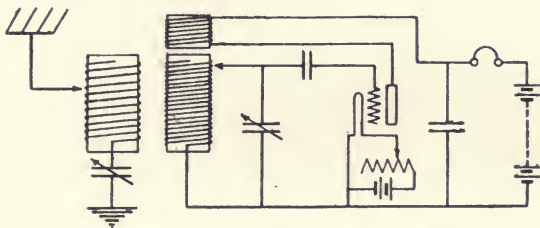

FIG. 117B.—Arrangement of Circuits for Using a Single Three-electrode Valve (bulb not shown) for Heterodyne Reception of Undamped Waves.

variation of this mode of connection, as shown in Fig. 117b, is also used in continuous wave reception, especially in the United States. Another circuit arrangement of a three-

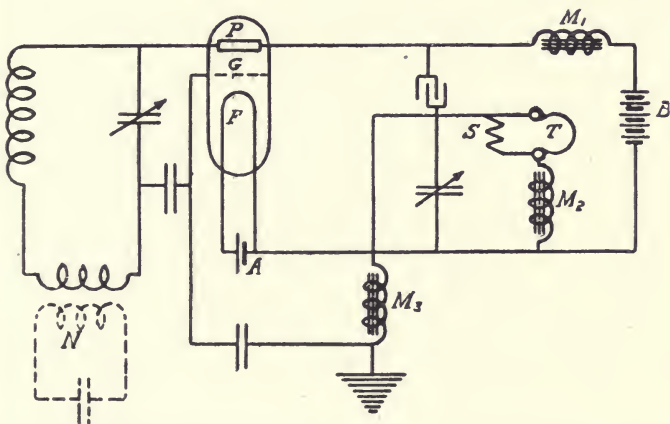

FIG. 118.—Lee de Forest's Ultraaudion Circuit. S is a Shunt on the Telephone for Signal Strength Measurement.

electrode thermion in which a reactive coupling is effected between the plate and grid circuit is that called by Lee de Forest the "ultra-audion" connection.¹ In this arrange-

¹ See United States Patent Specification No. 1,170,881 of Lee de Forest and Charles Logwood, application of March 12th, 1914.

THE THERMIONIC VALVE IN

ment the secondary or condenser circuit, which is coupled to the aerial, has its terminals connected to the plate and grid of the valve respectively, instead of the grid and filament (see Fig. 118). The plate circuit is, however, coupled to the grid circuit through a condenser, and an earth connection is made at one point on the plate circuit through an iron-cored choking coil.

E. H. Armstrong has redrawn the scheme of connections of this ultra-audion, as in Fig. 119, so as to bring it into closer

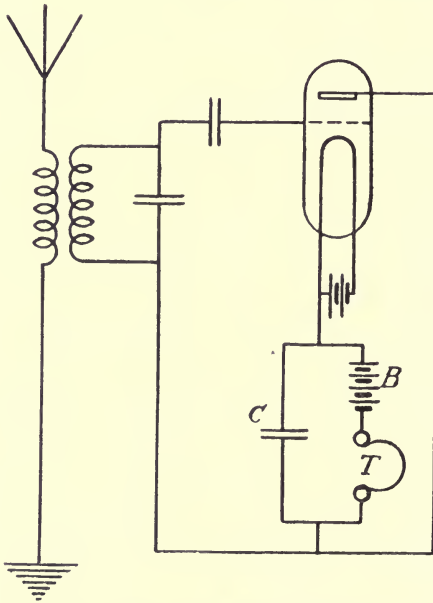

FIG. 119.—Armstrong's Redrawing of the Ultra-audion Circuits.

comparison with the normal three-electrode amplifying thermion method of working.

In virtue of the coupling through the condenser *C* there is a reaction between the grid and plate circuits which acts in a similar manner to the usual electromagnetic induction coupling. It will be noticed that the telephone is in parallel with the plate battery, and not in series

with it. The atmospheric disturbances are then slightly less troublesome with this parallel arrangement, but the sensitiveness to signal waves remains the same. The shunt, *S*, across the telephone, *T*, is for measurement of signal strength. L. W. Austin added the oscillating flywheel circuit marked *N* in Fig. 118, which he calls a sensitising circuit, and has stated that the sensitiveness of the whole receiver is increased three or four times by the use of this circuit *N*.

It consists of a capacity and inductance which is tuned

close to the resonance point, and is coupled to the secondary of the receiving circuit. By this means it is possible to work with a looser antenna coupling to the secondary receiving circuit without loss of sensitiveness. Austin states that careful comparison between this ultra-audion connection and the plain electrolytic receiver has shown that the sensitiveness of this ultra-audion is from 500 to 1,000 times greater than the plain electrolytic as measured by the shunted telephone method, and the audibility increases proportionately to the antenna current.¹

8. It is desirable in the next place to consider the use of the thermionic valve as a current-limiting device and for the suppression of atmospheric disturbances. The whole question of atmospherics, or strays, as they are called, or irregular electric oscillations set up in the receiving aerial by stray waves due to electric discharges or movements of electrons in the atmosphere, is a very large one. It cannot be fully treated here. Suffice it to say that the phenomena, as far as the radiotelegraphist is concerned, consists in a sudden electric impulse or series of impulses given to the aerial which set it and the receiving circuits in oscillation and create in the telephone various noises, clicks, sizzling, hissing or crackling sounds, which are loud enough often to drown out the message-bearing sounds and even to deafen, temporarily, the operator. In the early days of spark telegraphy, when the spark frequency was low and irregular, these atmospherics were so completely mingled with the signal sounds that separation was impossible by ear. Attempts to tune or filter them out were not very successful, because any brief electric impulse given to the aerial sets it and the receiving circuits vibrating with the natural frequency corresponding to the wavelength of the aerial and therefore of the signals to be received, and hence any filter which would stop out these stray vibrations would equally stop out the signals.

A very great improvement was therefore effected by the introduction of the high-frequency (300-1,000) musical spark by the use of Marconi's rotating dischargers or else suitable alternators, because this imparted to the message

¹ See L. W. Austin, "Experiments at the U.S. Naval Radio Station, Darien, Canal Zone," *Proceedings of the Institute of Radio Engineers*, New York, vol. iv., No. 3, p. 251, November 27th, 1915.

THE THERMIONIC VALVE IN

signals (dot and dash) a high-pitched musical sound and enabled the operator to distinguish them by ear from the irregular intermingled sounds to which he paid no attention. Even then, however, very loud atmospherics had the effect of reducing the sensibility for the moment of the operator's ear. If, however, the louder atmospheric sounds can only be reduced to the strength of the signal sounds their overpowering influence will be greatly diminished and the operator will be enabled to read through them. This is to a great extent accomplished by the use of *balanced crystal* or *balanced valve* detectors.

We can explain the principle involved in connection with a simple carborundum crystal detector. Such a crystal

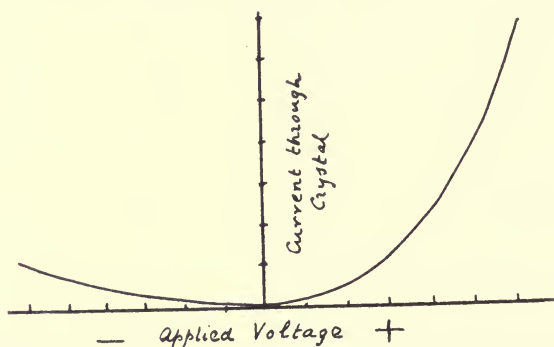

FIG. 120.—Characteristic Curve of a Crystal (Carborundum) Rectifier.

has a greater conductivity for electricity in one direction than the other. If we plot out a characteristic curve for the crystal delineating current transmitted on terms of applied voltage, + or -, it has the form shown in Fig. 120. This curve has changes of curvature at certain points. Suppose, then, that a crystal is placed in series with a high-resistance telephone and the two in series joined across the terminals of the condenser in the closed receiving circuit of a receiving aerial. If the signal waves could create a large alternating P.D. between the terminals of the condenser the rectifying power of the crystal would cause the telephone to be traversed by a much greater current in one direction than in the other. If the P.D. range is small, as it is in radiotelegraphy, then owing to

the form of the characteristic curve the rectification will not be so great.

If we apply a boosting voltage or direct E.M.F. to the crystal so as to bring the point of working to a bend or sharp change of curvature in the characteristic curve, then a small superimposed alternating voltage will produce a greater rectified current than if the boosting voltage is not applied, because at that point the effect of a given increase in the total voltage increases the current more than an equal diminution in the voltage decreases the current.

Suppose, then, that two such rectifying crystals are arranged in parallel with poles in opposite direction and joined in series with a single telephone across the terminals of the receiving condenser. These crystals will rectify in opposite directions. If, then, one of these crystals has its associated battery and potentiometer adjusted so as to apply a small boosting E.M.F., sufficient to bring the voltage to a point of change of curvature on the characteristic curve, the other crystal not being so assisted, the result will be that the two in parallel possess a rectifying power for small alternating voltages, but do not possess it for extremely large A.C. voltages. Hence the oscillations due to signal waves are rectified and detected by the telephone but any oscillations of large amplitude, due to an atmospheric discharge or vagrant wave, will not be rectified or, at any rate, will not create a sound in the telephone louder than those made by the signal waves. If, however, these latter are created by a musical spark the quality of the sounds will enable the operator to distinguish them.

Exactly the same effect can be produced by the employment of two Fleming valves instead of two carborundum crystals, provided we use valves not exhausted to an extremely high vacuum. By this ingenious arrangement forming the well-known balanced crystal or balanced valve receiver of Marconi's Wireless Telegraph Company, the interference of atmospherics with message signals is much diminished, and the effect of strong atmospherics in drowning out signal sounds is considerably reduced. In another arrangement, due to Lieut. G. M. Wright, of Marconi's Wireless Telegraph Company,¹ an ordinary three-electrode valve is employed as a current-limiting device by running

¹ See British Patent Specification No. 8,926 of June 17th, 1915.

THE THERMIONIC VALVE IN

the filament at a reduced temperature. Under these conditions the valve plate current can never exceed in strength a certain value. This may be arranged so as to be just equivalent to enabling the signal sounds to be read on the telephone of the crystal or other detector circuit, but any strong atmospherics cannot create a larger current. Hence the signal sounds are not swamped by excessively loud, irregular sounds, and can be read through them.

There are, however, objections to reducing the temperature of the valve filament, in that it makes the valve insensitive.

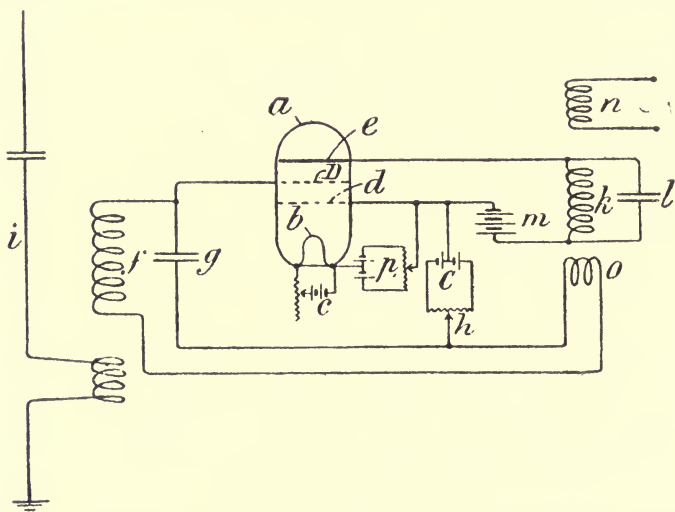

FIG. 121.—Connections of Method due to G. M. Wright for Eliminating or Reducing Atmospherics Depending upon Current-limiting Power of the Thermionic Valve.

Lieut. G. M. Wright has, however, found that a better result can be obtained with a valve containing a second grid, as shown in Fig. 121.¹

The valve has a filament, plate and two grids. The antenna, *i*, is coupled as usual to a closed oscillation circuit, *f*₁*g*, and reaction coil, *o*, which is coupled to the plate circuit. The diagram will show the mode of connection of the two

¹ See British Patent Specification No. 102,821 (1917) of G. M. Wright and Marconi's Wireless Telegraph Company; see also article by L. Schoenberg in *The Year-Book of Wireless Telegraphy* for 1918, p. 944.

grid and plate circuits respectively. The filament of tungsten wire is kept at the usual degree of incandescence corresponding to a temperature of about $1,700^{\circ}$ C. The inventor then finds that such a two-grid valve limits the plate current to an assigned amount, and the valve can be so adjusted that the limiting point is reached, even when a very small P.D. (corresponding to a weak signal) is made between the two grids. The coil n coupled to the plate circuit is in connection with the crystal or other detector circuit. In a following patent specification¹ granted to the

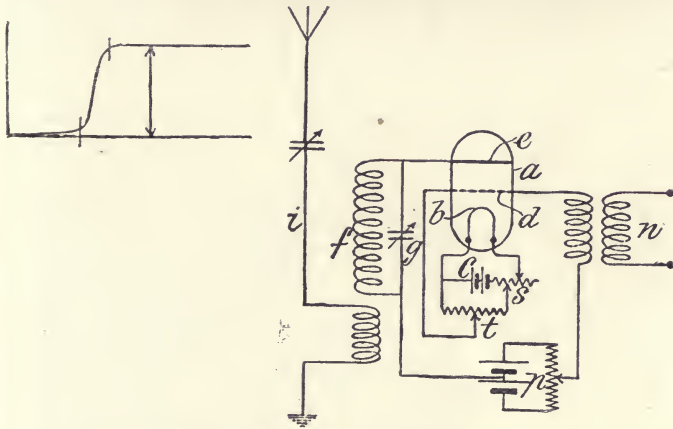

FIG. 122.—Connections of Method due to G. M. Wright for Eliminating Atmospherics Depending upon Current-limiting Power of the Thermionic Valve.

same patentees a single three-electrode valve of usual type is employed with a single grid of very fine mesh. The oscillating circuit which is coupled to the aerial is, however, connected between the grid and plate (see Fig. 122) instead of between the grid and filament.

The inventor states that with proper adjustments of potentials the space between the grid and plate becomes highly limiting, even for very small oscillatory currents, so that for a given potential of the grid the relation between the plate potential and plate current gives a characteristic

¹ No. 102,822 of 1917. It may be noted that after January 1st, 1915, British Patent Specifications began to be numbered consecutively upwards from 100,000.

THE THERMIONIC VALVE IN

current, which rises rapidly to a constant value which therefore limits the current, which can be transferred to the detector circuit n .

Methods of using three-electrode valves as a means of overcoming disturbance by atmospheric stray waves in the case of continuous wave reception have been described by Mr. E. H. Armstrong. He remarks that the effect of a strong stray wave on the valve is to build up a strong negative charge on the grid, which reduces the plate current, and that when the stopping condenser is without a leakage path

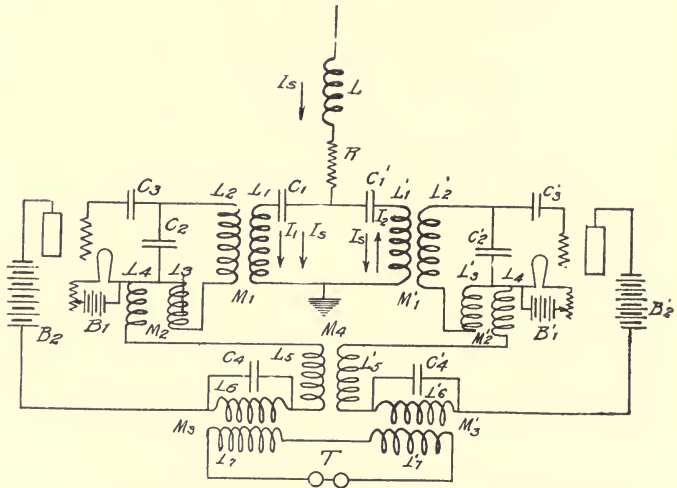

FIG. 123.—E. H. Armstrong's Connections for Eliminating Atmospheric Disturbances in case of Undamped Wave Reception by Beat Reception

this charge may persist for a considerable length of time, thus paralysing the valve for signal reception. He has contrived to take advantage of this fact by connecting to the aerial wire two similar systems, each comprising a thermionic valve, with grid and plate circuits reinforced and the plate circuits connected inductively to one single telephone.

These two systems are each arranged for beat reception, as above described, but the beat currents in the two systems are arranged to be 180° different in phase. The inductive coupling to the telephone circuit (see Fig. 123) is, however, so arranged that the two beat currents combine to affect the

telephone in the same direction and so assist each other. If, however, a powerful stray wave, which is always a highly damped wave, falls on the antenna it does not interact with the locally generated oscillations to cause beats, and is therefore not heard in the telephone. Hence, the method of beat reception by three-electrode valves is an effective means of eliminating strays, and this is one of the undoubted advantages attaching to the continuous wave system of radiotelegraphy.

CHAPTER VI.

THE THERMIONIC OSCILLATOR AND DETECTOR IN RADIOTELEPHONY.

1. As the principles of radiotelephony are now fully expounded in many books it is quite unnecessary to devote space in these pages to elementary facts or past achievements in the subject. We shall confine ourselves, therefore, to a brief mention of the applications so far made of thermionic valves in this department of radio work.

Broadly speaking, the accomplishment of radiotelephony involves the production of undamped electromagnetic waves, or, at least, waves produced by very high-frequency spark discharges, the amplitude or wave-length of which can be altered by a speaking microphone so as to vary proportionately to the ordinates of the wave form of the acoustic waves which create intelligible sounds. All human speech consists in the production of syllabic sounds by the vocal organs, which are connected and uttered in various tones, durations and sequences. These sounds comprise vowel and consonantal elements. The former are sounds which can be uttered continuously, in which the breath is expelled through the vocal chords of the larynx so as to give rise to a sound of a certain musical pitch or frequency, and the quality of this sound is influenced by holding the resonant cavity of the mouth in a certain form, which has the effect of creating harmonic oscillations superimposed on a fundamental frequency of the sound wave.

By special devices it is possible to delineate photographically, or in other ways, the wave form for each sound, and we then find that for every vowel sound there is a certain peculiar wave form. If this compound periodic curve is analysed by Fourier's theorem it will be found to consist of

a simple fundamental wave of sine curve form, with certain harmonics of 2, 3, 4, etc., times the frequency of the fundamental imposed upon it. The ear recognises the vowel quality by instinctively appreciating the relative amplitude of these harmonics, and to some degree their relative phase as regards the fundamental in the particular sound uttered.

The consonants are in many cases merely more or less abrupt or irregular beginnings or endings of vowel sounds, but in the case of some sounds, like *s* or *r*, they are produced by expelling the breath continuously with the lips and tongue and oral cavity held in certain positions.

When such vocal sounds are made in proximity to a thin circular metal diaphragm or elastic plate fixed at the edges the plate is set in vibration. The diaphragms used in ordinary telephone transmitters and receivers are generally about $2\frac{1}{4}$ in. in diameter and somewhere about .01 in. thick and are made of iron. Every such diaphragm has a fundamental natural rate of vibration of its own, like a violin string, but by bending along certain nodal lines the sections of the plate can vibrate in harmonic frequencies greater than the fundamental. The ordinary telephone diaphragm has a fundamental natural period of vibration of about 800 or 1,000 per second.

It is commonly said that when vocal speech is made near to such a diaphragm it reproduces in its movements the wave form of the sound uttered, but, as a matter of fact, such reproduction is very far from being exact. In order that such a diaphragm may copy in its motions the wave form of the incident air waves the diaphragm must have a natural frequency very much higher than that of any harmonic in the incident air wave.

The diaphragm of the human ear is a very thin membrane of small diameter, not much more than one-quarter of an inch in diameter, and it has therefore a very high natural frequency, which is the reason it responds so accurately to changes in quality or wave form of the aerial sound wave. Nevertheless, the iron telephone diaphragm does sufficiently copy by its motions the wave form of the air wave, although its resonance for particular frequencies equal to its fundamental or some harmonic is so marked that it responds far better to these than to any other incident wave frequency. In the ordinary carbon telephone transmitter the motions

of the diaphragm are caused to vary the pressure or compactness of carbon granules, and hence to alter their electric resistance and so change proportionately the current flowing through them under a steady impressed E.M.F.

2. As regards wireless telephony the problem of the transmitter is to create in the sending aerial continuous oscillations the amplitude of which can be varied in accordance with the wave form of vocal sounds made to the diaphragm of a carbon or other telephone transmitter, which must in some way be made to vary in like manner the amplitude of the oscillations in the aerial wave.

For permanent long-distance radiotelephony on a large scale the ultimate solution of the problem will no doubt be found in the use of high-frequency alternators in which the exciting or field current, or else the main current, is controlled by microphones through the agency of current amplifiers, perhaps of the thermionic type. Such high-frequency alternators, from their great cost and the large angular momentum of their rotating parts, are quite unsuited for use on board ship or for short-distance working. Hence, attention has generally been given to the employment of some type of arc generator or rapid-spark generator for the production of the necessary continuous oscillations. In spite of all the labours of inventors on the arc method it has not proved to be a very certain or satisfactory method for such continuous wave production. Irregular interruptions in the production of the continuous oscillations create corresponding noises in the receiving telephone and variations in the loudness of the sounds heard. The articulation, in short, is very imperfect and overlaid with disturbing noises which make good radiotelephony the occasional achievement of experts rather than a simple and certain process for everyday use.

The discovery that the three-electrode thermionic valve or thermion could be used for the production of pure sine wave electric oscillations of quite constant strength has given a fresh impetus to radiotelephony. Owing to the true sine wave form of the oscillations we are enabled to magnify at the receiving end with great advantages. Also, owing to the steadiness of the oscillations, very small antenna currents seem to suffice for the conduction of radiotelephony over some scores of miles.

Again, in consequence of the qualities of thermionic circuits we are able to eliminate noises due to atmospheric strays, or at least to keep them in subjection within reasonable limits. We have explained in Chapter IV. the principles on which the three-electrode thermion acts in creating electric oscillations.

It only therefore remains to consider the special arrangements necessary in the case of radiotelephony.

In the matter of power output the thermionic valve as an oscillation generator is at present somewhat limited. This, however, is very much a matter of construction.

There can be no doubt that the best type of thermion for use as a generator is the extremely high vacuum one. Any residual gas in the bulb must necessarily be ionised and the bombardment of the cathode by positive ions is a cause of its speedy destruction. Hence the pure electron discharge has unquestionable advantages. Another source of weakness is that the glass bulb is liable to crack and the conveyance of large currents through platinum wires sealed through glass is very difficult.

Pure silica is now commonly used in the construction of chemical apparatus, and it should not be impossible to construct large bulbs of silica with exhausting tubes which could be sealed when exhaustion is complete by the oxygen-hydrogen blowpipe.

Such silica bulbs do not crack with heat like glass, and the melting point being above $1,500^{\circ}$ C., they can be heated to very high temperatures during exhaustion. The sealing-in platinum wires might be in multiple, formed of many fine separated wires and a glass of suitable composition welded to the silica at the point of entrance.

Large incandescence lamps are now made taking 1 or 2 kilowatts to operate the filament, and giving 1,000 or 2,000 candle-power. Hence it should not be impossible to construct large three-electrode thermionic generators with silica bulbs in which 2 or 3 kilowatts could be dissipated internally if need be.

4. Turning, then, to the details of circuits employed, we may take as typical the methods described in the British Patent Specification No. 13,243 of 1914 of Captain H. J. Round, of Marconi's Wireless Telegraph Company, in which either one or two three-electrode valves are employed. In

THE THERMIONIC VALVE IN

the single valve arrangement (see Fig. 124) the grid circuit comprises an oscillation circuit P_2K_2 , and also in series with it a stopping condenser, K , which is shunted by a resistance, R_1 , and battery, B_1 . The plate circuit contains also an oscillation circuit, P_1K_1 , and a condenser, K_3 , shunted by a resistance, R_2 . G represents a direct current generator which may conveniently be a battery of storage cells giving 20 to 60 volts or so. The inductance coils P_1 and P_2 are arranged with mutual induction, and when used for radiotelephony there is an intermediate circuit which contains the speaking microphone which couples P_1 and P_2 .

The coil P_1 is also coupled to the aerial A . The mutual

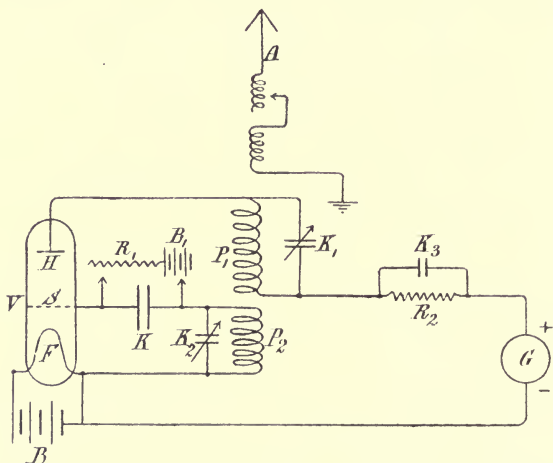

FIG. 124.—Arrangement of Circuits due to Captain H. J. Round, Using a Three-electrode Valve for the Production of Undamped Electric Oscillations in Radiotelephonic Transmitters.

inductance of the grid and plate circuits is made close enough to maintain oscillations in the system.

It is clear from the text of the specification that Captain Round employs a rather "soft" valve with not very high vacuum and that the gaseous ionisation which takes place at a certain grid potential plays a part in the process. The object of the resistance R_2 in the plate circuit is to prevent the plate current rushing up to the point at which an arc will start between filament and plate if this ionisation exceeds a certain amount, but the valve is worked at a

point just below that at which the current due to ionisation begins to increase rapidly. The operation of the arrangement is then as follows: The valve starts oscillating when the coupling of P_1 and P_2 is sufficiently close and the circuits P_1K_1 , P_2K_2 must be tuned to each other and to the aerial A . Undamped oscillations are thus set up in the aerial. When speech is made to the carbon microphone M in the intermediate circuit connecting inductively P_1 and P_2 the aerial current is varied proportionately to the change in resistance of the microphone. Hence the

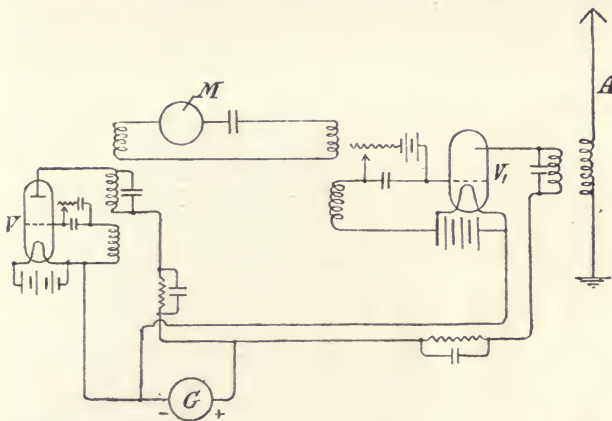

FIG. 125.—Arrangement of Circuits Employing Two Three-electrode Valves, due to Captain H. J. Round, for Production of Undamped Oscillations for Radiotelephony, the Amplitude being Controlled by a Microphone, M , in an Intermediate Circuit.

variation in amplitude of the aerial oscillations and waves follows the wave form of the speech waves.

In demonstrations made with this generator for the Italian Navy, Captain Round found that very small antenna currents such as 0.2 ampere were sufficient to enable radiotelephony to be conducted over 70 kilometres, owing to the perfect regularity of the oscillations and absence of stray noises, and hence ability to employ a magnifying valve as a receiver.

In another arrangement Captain Round employs two three-electrode valves in series connected as in Fig. 125, where the microphone M is shown in an intermediate

THE THERMIONIC VALVE IN

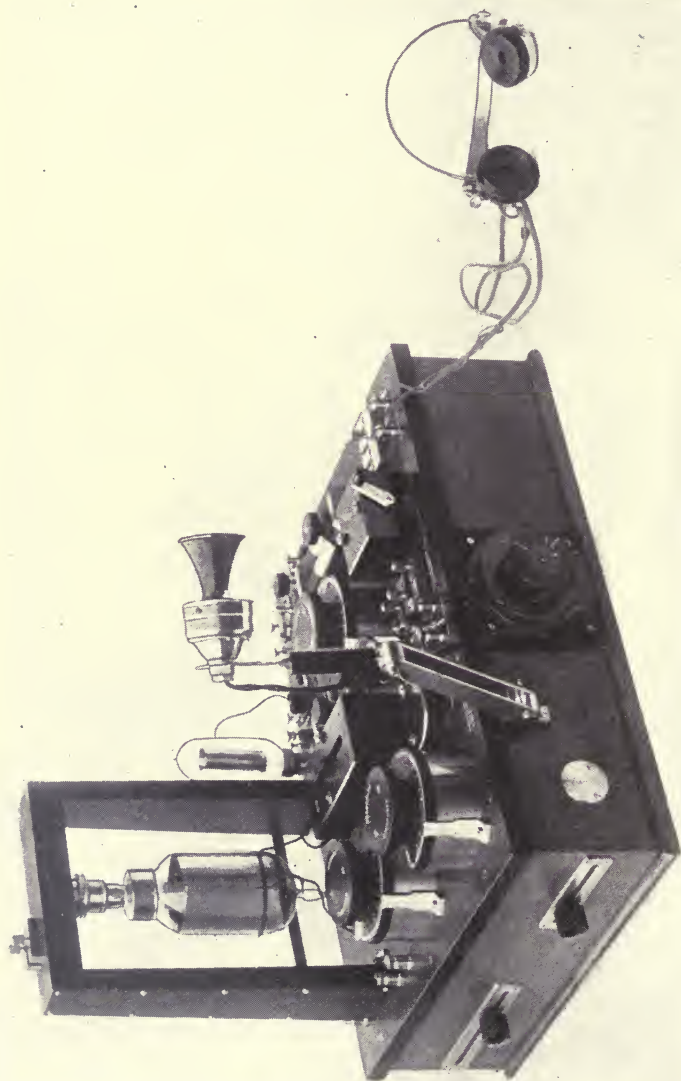

WIRELESS TELEPHONE SET.

FIG. 126. — Photograph of Wireless Telephone Apparatus Constructed and Used by Marconi's Wireless Telegraph Company, Ltd. (H. J. Round.)

circuit which couples the plate circuit of one valve with the grid of the next.

The microphone can also be placed if required in the aerial or antenna circuit provided the current in the antenna does not much exceed half an ampere, which is the limit of safe working with an ordinary carbon granule microphone.

As a receiver a three-electrode valve arranged with reacting grid and plate circuits is employed so as to magnify the incoming oscillations. As this receiving arrangement is the same as that employed in radiotelegraphy, described in Chapter III. (see § 6, Fig. 73), we need not refer to it again.

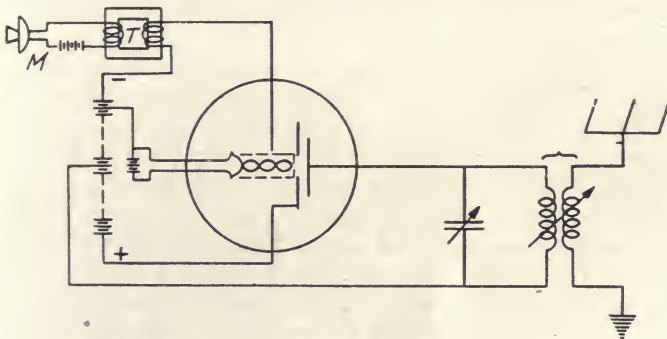

FIG. 127.—Scheme of Circuits for a Radiotelephonic Transmitter Employing a Pliodynatron, made by the General Electric Company of U.S.A., as Oscillation Generator.

The complete apparatus for radiotelephony, comprising generator, transmitter and receiver circuits, with all adjustable condensers, inductances, batteries and couplings, is made up by Marconi's Wireless Telegraph Company in one piece of apparatus, as shown in Fig. 126, and provides a complete outfit for radiotelephony.

The set delivers 0.6 ampere to the aerial, the microphone in this case being placed in series with the aerial. The apparatus enables radiotelephony to be effected between ships at sea at a distance of 30 miles. A larger antenna current of 1 ampere gives a range of 100 miles.

5. The structure and mode of operation of the type of thermionic generator called a dynatron and a pliodynatron have already been explained in Chapter IV. It remains to

mention the manner in which this appliance is utilised in radiotelephony.

The form of four-electrode thermion, called a pliodynatron by its constructor (see Fig. 93, Chapter IV.), comprises a metallic filament forming the cathode which can be rendered incandescent by a current. This is enclosed in a highly-exhausted glass bulb. Around this filament is a grid, and around that a perforated anode cylinder, and outside that a plate in the form of a cylinder.

The plate is connected to an oscillation circuit which is coupled inductively to the aerial (see Fig. 127).

In addition to the battery heating the filament a battery of larger voltage is employed, part of which is connected between the filament and the perforated anode, with the latter made positive. A cell or two of this latter battery is connected between the filament and the grid, and includes in this circuit the secondary coil of a transformer, in the primary of which is a telephone transmitter, microphone *M*, and battery. It has already been explained in Chapter IV. in connection with this instrument that if the current in the external plate circuit is plotted in terms of the potential difference between the plate and negative end of the filament the curve so obtained first rises up, then falls, and finally rises once more (see Fig. 89, Chapter IV.). In the middle region the current falls as potential difference increases, and the vacuous space may then be said to have a negative resistance.

In practice this line is a curved line, and the so-called negative resistance is inversely proportional to the grid potential. Hence, if the ratio of inductance to capacity in the external plate circuit is sufficient to start oscillations, as explained in § 7 of Chapter IV., a slight decrease in grid potential will stop the oscillations.

If the negative resistance part of the characteristic curve is not a broken straight line, but a gradually curved line, the gradual changes in potential of the grid will be accompanied by corresponding gradual changes in plate current, and this is just what is required to effect radiotelephony. Hence, if the plate oscillation circuit is coupled to an aerial, as shown in the diagram in Fig. 127, and if the grid circuit includes a microphone transmitter and transformer, speech made to the microphone will cause changes

of antenna current which repeat the motions of the microphone diaphragm, and therefore modulate the antenna current and radiated wave amplitude in a manner corresponding to the wave form of the speech made to the microphone.

6. By the use of a pliodynatron in this manner it was found possible to radiotelephone for 16 miles (=26 kilometres) with a small tube giving about 10 watts, the articulation and loudness of the received speech being quite good.

7. There are also other ways in which a three-electrode thermion can be employed to effect radiotelephony. Thus in the paper by Dr. Irving Langmuir on "The Pure Electron Discharge," already mentioned in Chapter III., in which a description is given of a high vacuum three-electrode thermionic tube called a pliotron, interesting information is given on its use in radiotelephony in more than one way.¹

By means of the large type of pliotron it has been found possible to control as much as 2 kilowatts of radiant energy from an aerial by an ordinary microphone transmitter. For example, a high-frequency alternator giving currents of 100,000 frequency has been designed by Mr. Alexanderson.

If such a 2-kw. alternator is loosely coupled to an antenna the aerial will radiate undamped electromagnetic waves of a certain amplitude.

If the plate of a pliotron is connected to a point on the antenna at which the potential is normally high, and if the filament of the pliotron is earthed, then when that point on the antenna becomes positive during one half of an oscillation a leak will take place. If, however, the grid is made negative it will stop this leak and the antenna will radiate its full amount of energy. Hence a very small negative charge given to the grid will control the radiation of a large amount of energy from the antenna.

Two pliotrons might also be so used, one having its plate connected to the aerial and filament earthed and the other having its filament connected to the aerial and plate earthed, whilst the grids of both are connected together and to one terminal of the secondary circuit of a transformer the primary of which includes a battery and speaking microphone, the other end of the secondary circuit being to earth. In this

¹ See *Proceedings of the Institute of Radio Engineers*, vol. iii., September, 1915.

THE THERMIONIC VALVE IN

manner the leak from the antenna can be modulated by speech made to the microphone diaphragm and the amplitude of the electromagnetic radiation from the aerial made to vary proportionately to the wave form of the speech wave. In place of a high-frequency alternator we may employ an arc transmitter or another oscillation-producing plotron or three-electrode thermion.

Dr. Irving Langmuir mentions (*loc. cit.*) that two types of this apparatus for effecting radiotelephony have been worked out in the laboratories of the General Electric Company of U.S.A.

The first has a capacity for supplying about 20 watts in the antenna and draws its supply of power from a city alternating current supply at 118 volts and 60 frequency.

This A.C. supply is connected to a small transformer having two secondary windings. One of the secondaries gives an E.M.F. of about 5 volts and furnishes the currents for heating the filaments of the thermion tubes used; the other secondary supplies current at 800 volts. This alternating current is rectified by a Fleming valve and employed to charge a condenser of 6 microfarads. In this way a source of direct current of high voltage is obtained. The plate and filament of the plotron oscillator is then connected to this condenser. The plate of a second plotron is connected to the grid of the first, and the grid of the second is connected through a small transformer with a microphone and battery. Speech made to the microphone then varies the potential of the grid of the second or smaller plotron, and the varying plate current alters the grid potential of the large one and hence varies the amplitude of the plate current of the latter and the amplitude of the waves radiated from the antenna coupled to the large plotron. In this outfit, which is suitable for use up to 500 watts or so, the high voltage direct current required for the plate circuit is derived from a small 2-kilowatt alternator. The current from this is rectified by a two-electrode thermionic valve after being transformed up to a voltage of 5,000 volts, and the resulting pulsating unidirectional current is smoothed out by being used to charge large condensers, from which a small steady current can then be drawn. The alternator gives a current having a frequency of 2,000, and it is therefore possible to store up large quantities of energy and obtain as much as a kilowatt

or more of power in the form of direct current. This high voltage D.C. is used to operate the plate circuit of the oscillating thermion, the alternating output of which is modulated by the smaller thermion governed by the microphone connected to it. The high-frequency alternator may, of course, be driven by a D.C. motor or by a small petrol engine. In this manner a completely independent radiotelephonic plant is constructed.

By means of this system of control the amount of power in the telephone transmitter or microphone circuit need be no larger than in ordinary wire systems of telephony, so that it is possible to actuate such a radiotelephone plant as is above described from a distance by telephonic speech transmitted over a wire.

At the other end the radio-receiver system can be made to retransmit the speech received over telephonic land lines, and thus the radiotelephone used to bridge over a gulf, say a large lake or sea region, and thus avoid the expense of laying a telephonic cable.

Radiotelephony by means of thermionic valves assumes therefore a very practical aspect and is in a much more satisfactory practical condition than when in the stage at which the arc form of generator was its principal resource and foundation.

Finally, it may be mentioned that the three-electrode valve has come into extensive use as a telephone relay or repeater and amplifier in connection with telephony with wires, especially on very long loaded circuits. For this purpose it has exceptional value, as it provides an absolutely inertialess relay of great sensibility and perfect repeating power. By using thermionic repeaters in cascade, say three, at intervals in long lines we can furnish the telephonic current at intervals with fresh energy and restore the amplitude of the higher harmonics in the current wave, on which the intelligibility of the sound essentially depends. An interesting Paper was read by Mr. A. B. Hart on this application, entitled "Telephonic Repeaters," and an abstract of it will be found in the *Journal of the Institution of Post Office Electrical Engineers* for April, 1919.

CHAPTER VII.

RECENT IMPROVEMENTS IN THERMIONIC APPARATUS.

1. Very great advances were made in the construction, mode of use and theory of thermionic apparatus for radiotelegraphic and telephonic work just before and during the European War of 1914–1918. As the earlier chapters of this book were written before the armistice was signed in November, 1918, certain limitations in the information given were then necessarily imposed. It is, however, possible at the present time (1919) to describe a little more in detail some of the chief improvements and additions to knowledge on the subject in the last few years.

In the construction of the three-electrode valve various types have been adopted. In some cases the glass vessel has a tubular form with a straight filament stretching from one end to the other. The "plate" is a cylinder of thin metal, generally nickel, and fits pretty closely to the inner side of the tubular bulb. The grid is a spiral of nickel wire or tube of metal gauze, which surrounds the filament without touching it. Connections to the cylinder and spiral or grid are sealed through the glass bulb. Of this type is the Marconi Company's "Q" valve. In the construction of "hard" valves which are now mostly used, the entire elimination of the occluded gases from the metal work is most important, as otherwise the vacuum will not remain constantly high in use.

The extrication of these gases is effected by electronic bombardment of the metal by means of a high-tension transformer or induction coil which has one secondary terminal connected to the valve filament and the other to the grid and plate during the process of exhaustion. When the vacuum reaches a certain point the bulb is seen to be full of a blue glow, and at a somewhat higher vacuum the metal

cylinder and grid become red hot, due to the electronic bombardment then taking place on them. The air exhaustion must be kept going until all the blue glow quite vanishes, showing that there is then no sensible ionisation of residual gases, because these are almost entirely absent from the bulb. Meanwhile, the filament is kept incandescent and the glass bulb heated. The vacuum required for a good "hard" valve is about 10^{-7} or 10^{-8} of a millimetre of mercury, which is far higher than is usual in a metallic filament lamp. The valve is then sealed off carefully. Many valve manufacturers take objection to the tubular form of valve in which the plate or cylinder fits closely to the inside of a tubular bulb, as they say there is then much greater difficulty in freeing the metal from occluded gas by electronic bombardment, without at the same time cracking the glass bulb.

The form of valve figured in Fig. 67 in Chapter III. is therefore preferred. In this case the filament, spiral, and cylinder are all fixed to a glass stem or tube through the top of which the platinum leading-in wires are sealed. This stem is then introduced into a spherical bulb, and sealed in at a place well removed from the leading-in points, and the metal work is kept at a distance from the glass bulb walls.

An important matter in valve construction is the degree of closeness of winding of the wire or mesh which forms the spiral or grid, and the behaviour of the valve will greatly vary with the degree of closeness of the turns of the spiral and with the proximity of the spiral to the filament. If the spiral is very open then it permits the free passage of electrons forming the plate current, and this current may then be large, but the grid will have to be raised to a relatively high negative potential to reduce the plate current. In other words, the slope of the characteristic curve will be small.

There are, in fact, two characteristic curves which have to be taken into consideration in connection with three-electrode valves—viz., (1) the curve expressing the relation of plate current and potential difference of grid and filament, and (2) the curve expressing the relation of plate current to resultant potential difference between plate and filament. It is this latter curve which gives us the effective conductivity of the vacuous space between the filament

and the plate. This conductivity can be increased by increasing the size of the filament and bringing the cylindrical plate nearer to it. The plate current is a function both of the E.M.F. in the plate circuit and of the grid voltage. It would be a great advantage if means could be devised of varying the closeness of the grid or size of the perforations in it after the bulb is exhausted and sealed. One of the difficulties of valve work is that there are so many factors which can be varied and which affect the resulting operation. The filament is now almost always made of drawn tungsten wire and is cut such a length as to be brightly incandesced to a brilliancy of about $1\frac{1}{4}$ watts per candle power by a voltage of 3.75 volts. The filament can then be worked at the proper incandescence by three storage cells with an adjusting rheostat in series. It is desirable to have fairly large cells, so that the voltage does not quickly drop in use. Also, when a number of valves are used in cascade, it is then possible to work the filaments of all valves used in parallel off the same two or three storage cells, each filament having, if necessary, its own adjusting rheostat.

In the case of aeroplane sets the current for the valve filaments can be supplied from a small D.C. dynamo driven by an air propeller screw. But then small storage cells should be kept across the terminals to equalise the voltage. In regulating the filament voltage the operator is guided by experience as to the highest temperature the filament will bear for 1,000 hours or so of use without being burnt out. It is for this reason that a substantial filament is an advantage, but then this takes a larger current. In some valves two filaments are provided so arranged that if one is burnt out the second can be brought into action, and thus the valve saved for further use.

The electromotive force required in the plate circuit is generally provided by small storage cells in ebonite or celluloid boxes.

In general the external E.M.F. required in the plate circuit of a very hard valve is 100 volts, or even more, to produce a plate current of 3 or 4 milliamperes with the grid at zero potential. This necessitates the use of at least 50 small storage cells. In the case of rather softer valves this E.M.F. may be reduced to 40 volts or less. In the case of fairly soft valves with thick filaments and

plate or cylinder near to the filament, the impressed voltage may be as low as 25 or 30 volts, and yet give the required plate current in virtue of the reduced vacuum resistance so obtained.

When valves are worked in cascade, if the several valve circuits are completely separated by induction coils or condensers, the same plate battery may be used to provide E.M.F. in the plate circuits of all the valves with a corresponding reduction of weight and cost. Also by the use of a filament-heating battery of a sufficient number of cells provided with a rheostat in series with the filament and a potentiometer resistance across the terminals of this single battery, one and the same battery can provide the filament-heating current and also the E.M.F. for the plate circuit.

With respect to the telephone inserted in the plate circuit of the valve, or last valve of the series, it is sometimes a high resistance telephone inserted directly in the plate circuit, but is preferably a low resistance instrument connected to the secondary circuit of a small iron-cored induction coil, the primary fine wire circuit of which is joined into the plate circuit.

The internal resistance of the valve being generally high, 10,000 to 100,000 ohms or so, and the E.M.F. of the battery in the plate circuit being usually 100 volts or so, the above inductive coupling of the telephone receiver avoids the risk of shocks to the operator and also breakdown of the telephone receiver insulation and enables a less expensive telephone to be used. It is generally necessary to put a condenser across the terminals of the fine wire high resistance coil of the induction coil which is inserted in the plate circuit.

2. As regards the arrangements of valves for reception in spark telegraphy, it is usual to employ one or more valves in cascade as radio-amplifiers in the first place. The rectification and detection of the oscillations may then be achieved by the use of a crystal (carborundum), or, if desired, by a three-electrode valve with or without stopping condenser in the grid circuit as explained in Chapter V.

Finally one or more valves in cascade can be used for the audio-amplification of the rectified trains of waves.

As an illustration of such a valve receiver we give in Fig. 128 an illustration of the Marconi Company's amplifier

THE THERMIONIC VALVE IN

and detector, Type 50. It is a four-valve set used in conjunction with the usual tuner. It comprises a teak box with an ebonite panel, on which are mounted four small tubular valves, a series resistance and a potentiometer. The first three valves on the left are used in cascade for

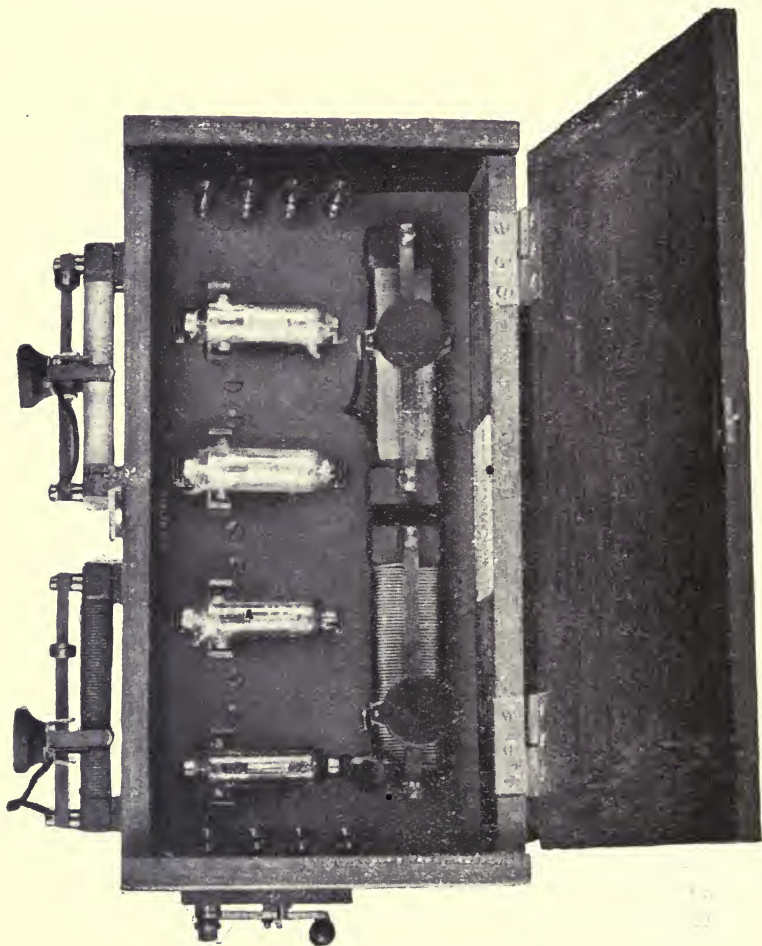

FIG. 128.—The Marconi Company's Valve Amplifier and Detector, Type 50.

radio-amplification, and the fourth on the extreme right for rectification and detection. The amplifying valves are of the type known as V 24, and the rectifying valve of the "Q" type.

RADIOTELEGRAPHY AND TELEPHONY

The lamp filaments are worked in parallel off a 3-cell storage battery giving 6 volts, and the sliding rheostat

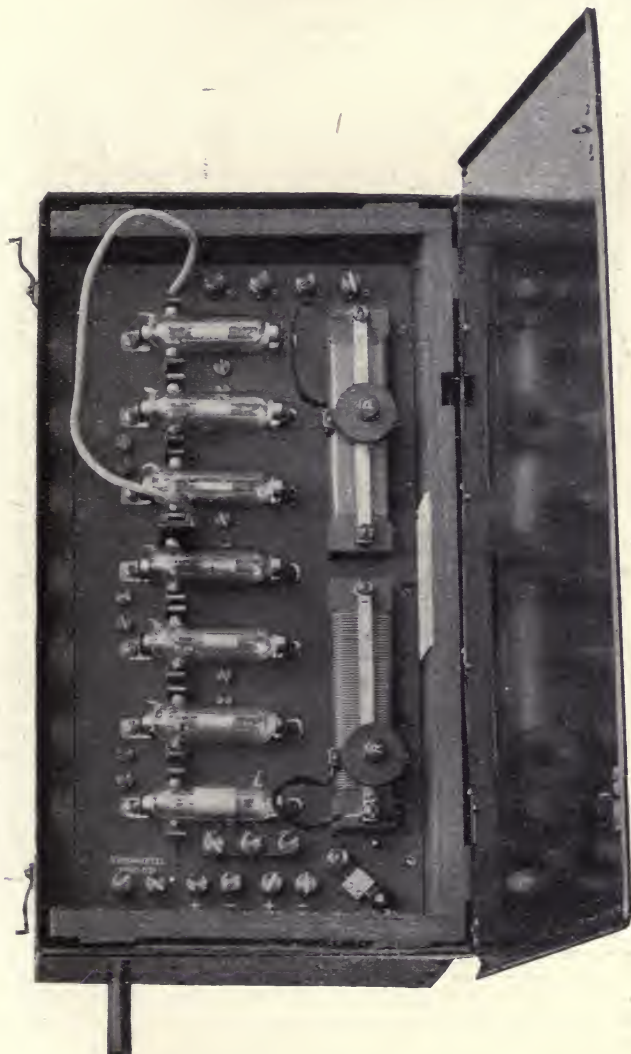

FIG. 129.—The Marconi Company's Valve Amplifier and Detector, Type 55.

inside the box controls the filament currents of the amplifying valves. The rheostat controlling the filament current of the detector valve is on the outside top of the box. The

THE THERMIONIC VALVE IN

potentiometer inside the box controls the potential of the grids of the three amplifying valves and that on the outside the grid potential of the detector or rectifying valve.

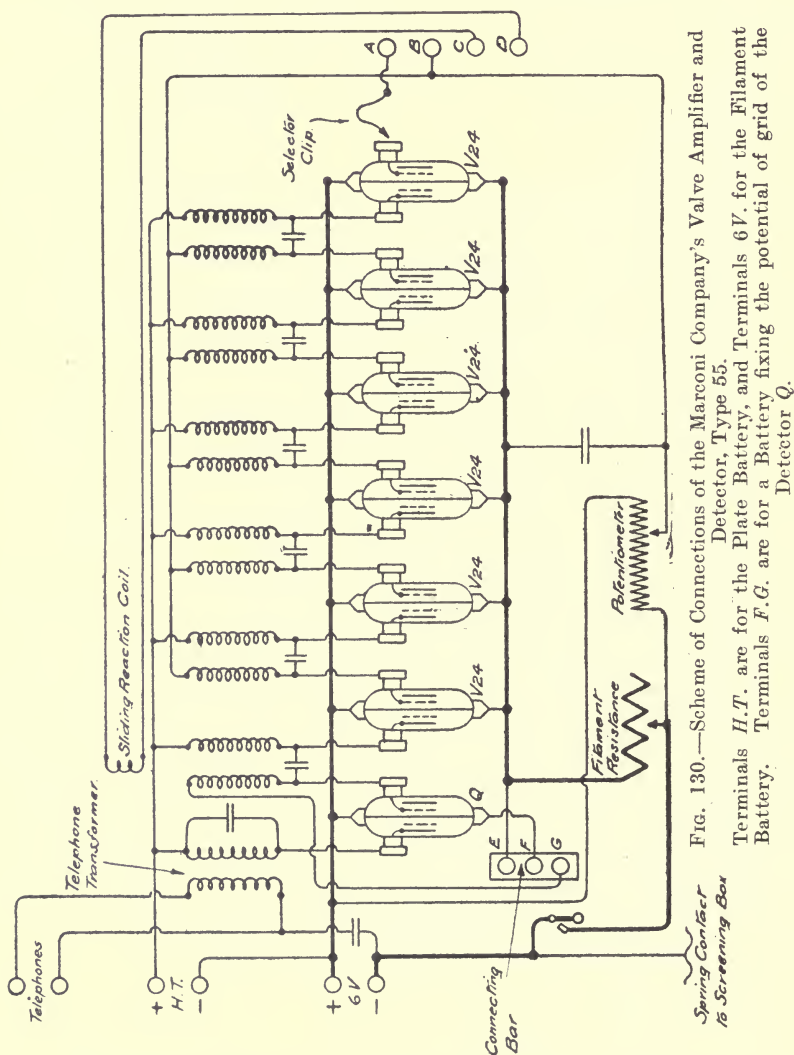

Fig. 130.—Scheme of Connections of the Marconi Company's Valve Amplifier and Detector, Type 55. Terminals *H.T.* are for the Plate Battery, and Terminals *6V.* for the Filament Battery. Terminals *F.G.* are for a Battery fixing the potential of grid of the Detector *Q.*

The plate currents are supplied from a 12-cell storage battery. The receiving telephone is a 60 ohm double head magneto.

This particular set is adjusted for a wave length of 600 metres. Another similar supersensitive valve receiver set, called Type 55, is made by Marconi's Wireless Telegraph Company, and contains seven thermionic valves. A view of it is shown in Fig. 129. The first six valves in the set which are joined in cascade are of the V 24 type, already mentioned, and the seventh is a rectifying valve of the "Q" type. A six volt storage battery supplies the current for incandescing the filaments of all the valves, and a 25-cell (50 volt) battery supplies the plate E.M.F. to produce the plate currents in all the valves. The sensitiveness of this set is such that if a few turns of wire are wound on a square wood former of 2 ft. length in side and this closed circuit aerial connected to the first amplifying valve, the telephone in the plate circuit of the last or detector valve will yield loud signals from ordinary ship installations 200 or 300 miles away provided the plane of the closed receiving coil is vertical and approximately in the direction of the transmitter sending out the waves.

The scheme of connections of this last set is shown in Fig. 130. In the first six radio-amplifying valves, V 24, the grid circuit of one valve is connected to the plate circuit of the previous valve by means of a transformer or induction coil, and the two coils of this transformer are joined across by a small condenser. The grid of the detecting or last valve, Q, is then oscillated in potential over a greatly magnified range and in the grid circuit of the last or detecting valve a variable E.M.F. derived from a potentiometer can be applied so as to fix the point of working at the lower or upper bend of the characteristic curve. As already explained, the oscillations of potential of the grid then cause oscillations in the plate current, but these can be so adjusted by working at the selected point of curvature that the mean value of the current through the telephone connected with the plate circuit of the detecting valve is increased or diminished by the signals and a sound is heard therefore as long as damped waves impinge on the receiving aerial. The details of the arrangement will be understood from the diagram in Fig. 130.

As the induction coils interconnecting each valve have a fixed inductance, and as the condenser connecting the two coils has a fixed capacity, there is a limited range of wave

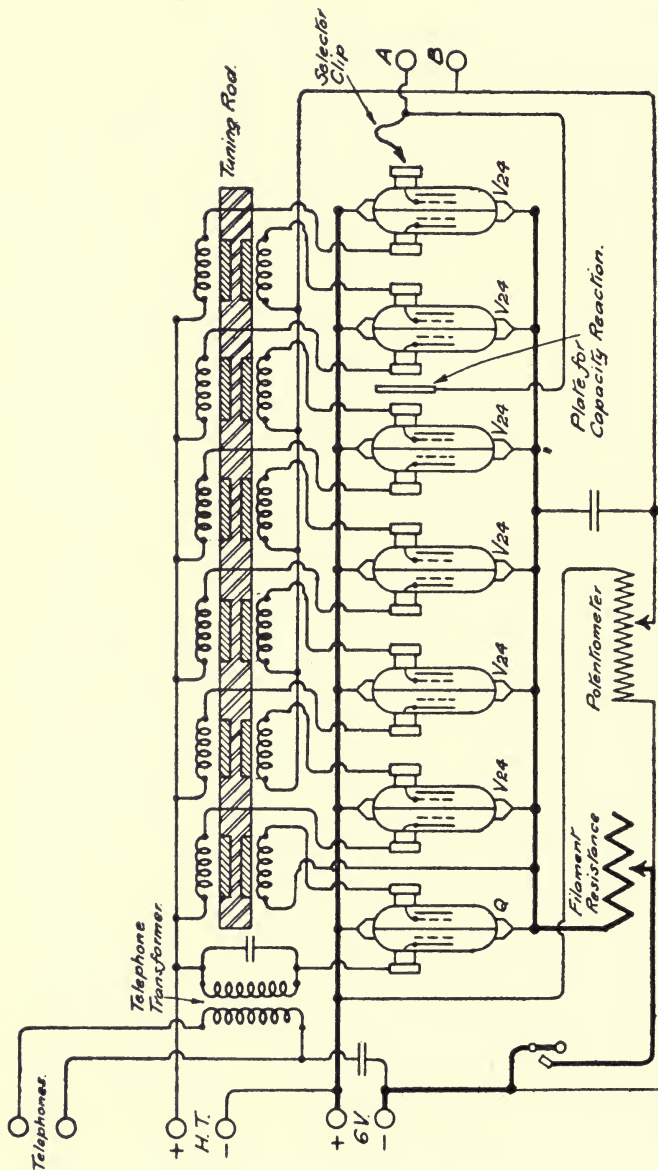

FIG. 131.—Scheme of Connections of Marconi Company's Valve Amplifier and Detector, Type 55, with Tuning Rod carrying powdered iron Cores for varying the wave length of receiving tune.

Spring Contact to Screening Box.

lengths or even an exact wave-length for which such a series of cascaded valves will operate as a detector. With the object of being able to vary this wave-length over somewhat wide limits, the Marconi Company supply a valve set in which a peculiar kind of iron core is made to slide in or out of the coils of the interconnecting transformers. This core is a wood rod, having cast round it cylinders of paraffin wax impregnated with finely divided iron. This core cannot absorb energy by eddy currents produced in it, but it serves, when pushed into the coils, to increase the inductance, self and mutual, of the coils, and thus varies the natural wave-length of the set. The arrangement is shown diagrammatically in Fig. 131.

3. The immense superiority of modern valve receiver sets in spark radiotelegraphy as compared with any crystal or magnetic detector or simple rectifying valve is due principally to the properties of the three-electrode valve in virtue of which a number can be used in cascade and also to the intercoupling of the grid and plate circuits usually called the re-action coupling.

In the case of continuous wave (C.W.) transmitters the power of generating oscillations which is possessed by valves with close grid and plate coupling makes practicable methods of heterodyne and autodyne reception which have quite revolutionised wireless telegraphy. We are then very much concerned with the methods by which valves are connected in cascade and the difficulties involved. In what follows we shall quote freely from a valuable article by Mr. J. Scott-Taggart in *The Wireless World* for February, 1919 (p. 628), on "The Use of Impedance, Capacity, and Resistance Couplings in High Frequency Amplifiers."

Broadly speaking, it is an advantage to use the thermionic valve as a radio-amplifier or magnifier of the high frequency oscillations, and then to make these enhanced oscillations affect a valve used as a detector, and if need be to afterwards amplify the audio-frequency oscillations thus produced. It is not good practice to put the detector valve first in the series and then employ other valves solely to magnify the audio-frequency oscillations or rectified trains. As a general rule the weaker the signals the less efficient is the valve as a detector because the changes of slope in the normal characteristic curve are gradual; in other words, the bend in the

curve is not sharp and hence, as already explained, the changes in potential of the grid produce hardly any variation in the mean value of the plate current : unless the amplitude of the oscillations exceeds a certain minimum. It is better therefore first to strengthen the incoming oscillations by a suitable number of valves in cascade, and then to detect and afterwards amplify again.

We shall now proceed to discuss some of the methods of intercoupling of valves in cascade when used as radio-magnifiers.

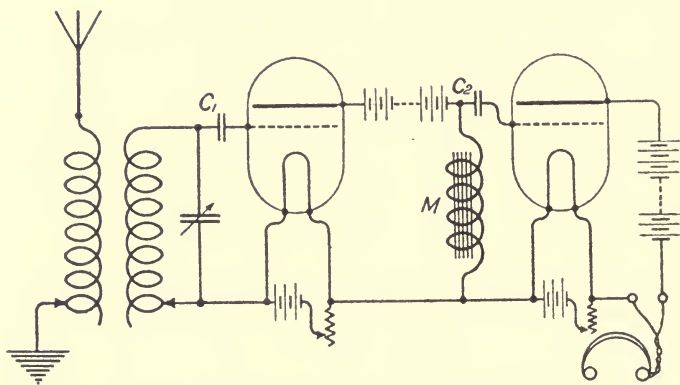

FIG. 132.—Receiving arrangement of two Valves coupled through an Iron-cored Choker, due to Mr. A. Hoyt Taylor.

In place of a simple induction coil it is possible to couple two valves through a choking coil as shown in Fig. 132. This arrangement is due to Mr. A. Hoyt Taylor. A small stopping condenser C_1 or C_2 , is placed in series with the grid of each valve. The plate circuit of the first valve contains an iron-cored choker M , which permits the passage of the steady D.-C. plate current furnished by the battery, but stops the H.F. oscillations. The result is that pulsatory voltages are impressed on the grid of the second valve, producing loud signals in the telephones inserted in the plate circuit of the last valve. With selected valves and such a circuit, signals from Nauen, near Berlin, have been read at North Dakota, a distance of 10,000 miles on an aerial 75 feet high.

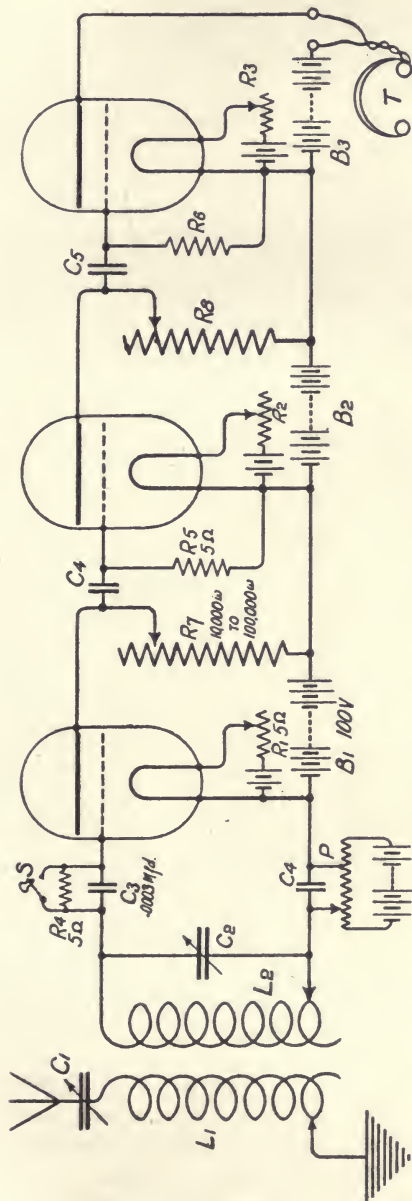

FIG. 133.—Receiving arrangement of Valves in Cascade coupled through high resistances. (J. Scott-Taggart.)

THE THERMIONIC VALVE IN

In place of the inductance or choking coil we can employ a simple high resistance coil of wire as a coupler.

Mr. Scott-Taggart has described (*loc. cit.*) a number of such cascade arrangements. Fig. 133 shows one such scheme. A condenser of small capacity, .0003 mfd., is placed in the grid circuit of each valve, and a very high resistance of about 5 megohms is connected across each grid and filament. This last resistance is made by making a groove in a slip of ebonite and rubbing an ordinary lead pencil along the groove so as to cover it with plumbago. Suitable metal contacts and terminals are provided at each end of the groove. In each plate circuit is also placed a high resistance capable of being varied from 10,000 to 100,000 ohms.

The function of this plate resistance is similar to that of the choking coil in Mr. Hoyt Taylor's scheme. The rapid oscillations of potential and the slow variations due to the plate current are by the resistance communicated to the grid of the next valve.

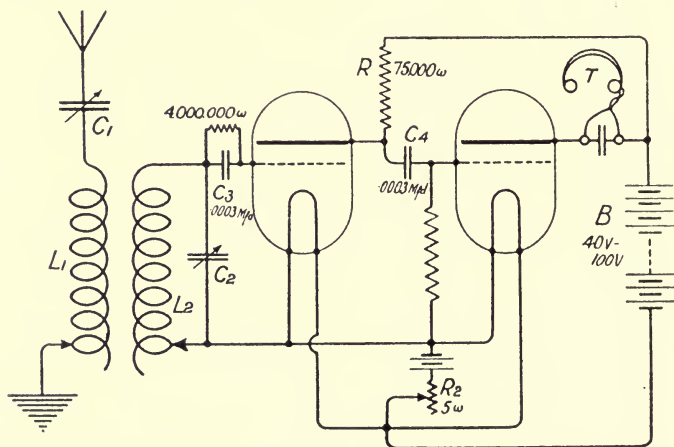

FIG. 134.—Receiving arrangement of two Thermionic Valves, both used as Rectifiers, coupled through a very high plumbago resistance. (J. Scott-Taggart.)

In Fig. 134 is shown another mode of coupling two valves described by Mr. Scott-Taggart as follows:—

Both valves are used as rectifiers and have leaky condensers in their grid circuits. In the case of the second valve the leak, which is of about 4 megohms, is connected

between the grid and filament of the second valve. The resistance R is about 75,000 ohms. Only one 100-volt battery is used for both plate circuits and one 6-volt battery for incandescing both filaments.

The telephone in the second plate circuit is shunted by a small condenser.

In this arrangement oscillating high frequency potentials are set up across the resistance R , and also much slower variations with beat or spark frequency, if a spark transmitter is employed. At the foot of R we have, therefore, voltage impulses of radio- and of audio-frequency and these are communicated to the grid of the second valve and are amplified into audio-frequency variations of plate or telephone current.

In Fig. 135 is shown a four-valve amplifying circuit of great efficiency. The first valve is used as a radio-amplifier and has a potentiometer in its grid circuit to adjust the potential of its grid to the point on the characteristic curve which gives the greatest plate currents variation. The three other valves have coupling resistances of about 80,000 ohms. Variation of potential are therefore produced at the foot of the resistance R_1 and impressed on the grid of the second valve. This valve and the two remaining ones act as high and low frequency amplifiers and as rectifiers, since they have leaky condensers in their grid circuits. Their filament currents are controlled by a common resistance R_4 and the receiving telephone is placed in the plate circuit of the last valve. The last plate circuit and the first grid circuit can also be coupled through a small condenser or a resistance, and this coupling (shown by the dotted line) strengthens the signals by the reaction principle already explained.

Fig. 136 shows a six-valve receiving set designed on the same lines. Here the first valve on the left is used as a pure amplifier of high-frequency oscillations and the remaining valves are amplifying rectifiers. Circuits are arranged for re-active coupling of the first grid circuit and the plate circuit of any following valve.

4. The thermionic valve finds one of its greatest fields of utility in the reception of continuous waves (C.W.). It may be said without fear of contradiction that the discovery of the oscillation-generating power of the three-electrode

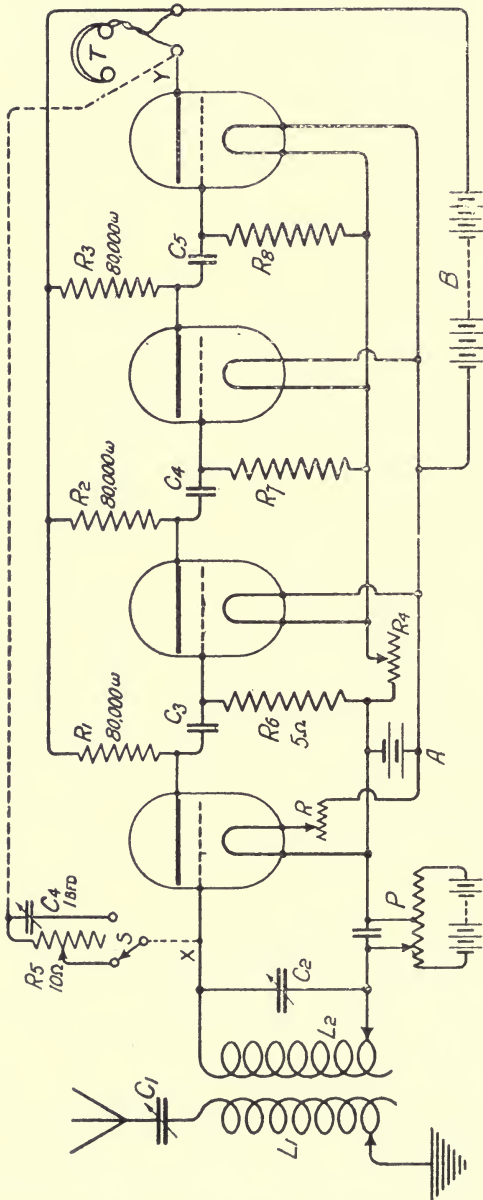

Fig. 135.—Receiving arrangement of great efficiency, comprising four Thermionic Valves in Cascade, coupled through high resistances.

valve gave new life to methods of C.W. production, such as that of the Poulsen arc and the H.F. alternator.

The heterodyne method of beat reception was at most a possibility until the oscillating thermionic valve replaced a very expensive H.F. alternator as a local H.F. oscillation generator. Accordingly, methods for the utilisation of the thermionic valve in C.W. production and reception have attracted great attention.

We shall mention first some arrangements for using the thermionic valve as a transmitter or generator of oscillations. For this purpose the thermion is generally made with a much larger bulb, and thicker and perhaps higher voltage filament, than is usual in the case of receiving valves. Much more power has to be obtained from it, or modulated by it, and it therefore becomes much hotter in use. Again, it is essential that a generating thermion should be of very high vacuum so as to avoid rapid destruction of the filament by ionisation in the bulb. The surface exposed by the incandescent filament must also be greater than in a receiving valve, and this means a higher filament voltage and larger filament-heating battery. Grids and plates are also made of more substantial metal in the oscillating thermion than in the receiving valve.

The following is a description of a simple C.W. generating set, described by Mr. J. Scott-Taggart in *The Wireless World* for April, 1919, in an article entitled "Practical Notes on the Use of Small Power Continuous Wave Sets."

The aerial (see Fig. 137) is in series with a tuning coil, L , and this is shunted by a small tuning condenser C_1 of variable capacity averaging about .005 mfd. Another condenser C_2 is inserted between the base of the coil L and the earth, having a hot-wire ammeter, A , in series with it. The plate P of the valve is connected through a high tension battery of about 400 volts and a key K with the upper end of the coil, L . This battery is shunted by a small condenser.

The grid G is connected through a coil R with the filament of the valve and the coils R and L are coupled inductively with a variable coupling.

The frequency of the oscillations set up depends on the inductance L and on the capacity C_1 and to some extent on the coupling of R and L .

As regards the aerial, the range depends upon the height, but the advantage of height is not so great as in the case of spark transmitters, and it is advisable not to employ an aerial longer than necessary. A directive aerial about 30 feet long and 3 feet high will enable communication to be carried on over 5 miles or more. If the coupling of the coils R and L is sufficiently close, then on closing the key K the system will commence to oscillate and the ammeter A should read about 150 milliamperes and should be capable of being increased to about 300 milliamperes by careful adjustment.

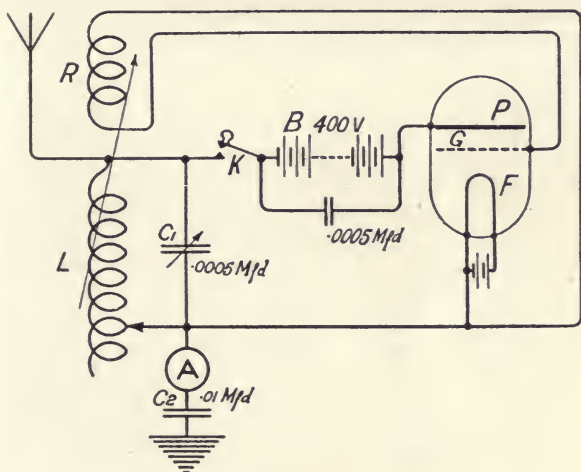

FIG. 137.—Arrangement of Circuits for using the Three-Electrode Thermion as a Generator of Oscillations, with Coils R and L in the Grid, and Plate Circuits coupled closely together.

This current should be perfectly constant as long as the key is kept down. It is convenient to tune for a wave-length of about 1,000 metres, which implies a frequency of 300,000. As regards C.W. receiving arrangements the following schemes of connection have been given by Mr. J. Scott-Taggart in *The Wireless World* for May, 1919, in some "Practical Notes on the Use of Small-Power Continuous Wave Sets."

Fig. 138 shows a typical C.W. reception valve set.

The aerial tuning inductance L is connected across the grid and filament of the valve. C₁ is a variable tuning con-

THE THERMIONIC VALVE IN

denser and C_4 is a condenser of .01 mfd. capacity in series with the earth. C_2 is a small stopping condenser made leaky by being shunted by a high resistance formed by a few plumbago lines drawn on ebonite. In the plate circuit of the valve is a reaction coil R coupled to the aerial tuning coil L by a variable coupling, also a battery B giving voltage up to 100 volts and a pair of high resistance telephones T . A small shunting condenser C_3 is placed across the telephone and battery, which affords a path for the high frequency oscillations in the plate circuit. In place of the high resistance telephones a low resistance telephone coupled inductively to the plate circuit is preferable.

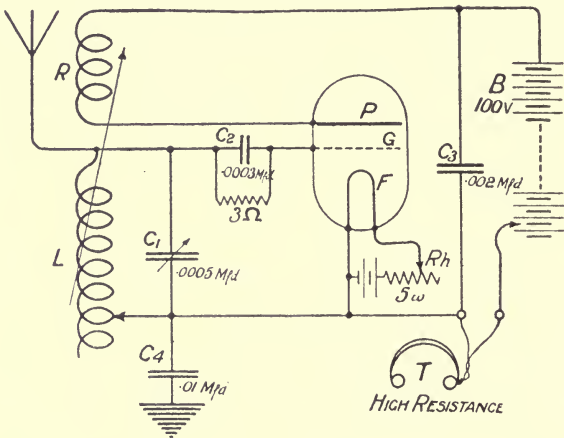

FIG. 138.—Typical Reception Set for C.W. Signals consisting of an Oscillation-producing Thermion, which creates audible beats by interference with arriving Continuous Waves.

To receive continuous waves the arrangement must be set oscillating, and for that purpose the coupling between R and the aerial inductance must be increased gradually until the self-produced oscillations start. This may be recognised by noticing the tone of spark signals received. They are very hoarse, no matter what their frequency. Also, if the aerial terminal is touched there should be a sharp click in the telephone, or, if the aerial tuning inductance is opened or the tuning condenser short-circuited, the same click will be heard. The best way, however, is to hold a vacuum tube fitted with rarefied Neon near the tuning inductance coil. If the oscillations are being produced the tube will

glow. If none of these effects are produced then the valve is not oscillating and will not therefore detect C.W. signals.

To make it detect them we have to alter the frequency of the self-produced oscillations until they differ from that of the incoming waves by about 500-700. The result is to produce beat oscillations in the valve circuits which are then heard as a shrill note in the telephone. The natural period of oscillation of the valve circuits must, however, be greater than about 20,000 so that no sound is heard in the telephone unless C.W. waves fall on the aerial conveying messages.

This tuning of the valve circuits is effected by altering the capacity of the condenser which shunts the inductance in the plate circuit of the valve. The heterodyne reception method has the great advantage that the receiving operator can alter the pitch or note of the signal sounds by varying slightly the natural frequency of his own generating set. Also it has far greater exemption from atmospheric disturbance than in the case of spark or damped wave radiotelegraphy. The natural atmospheric discharges are all damped waves of not very small decrement, and hence will not combine with the locally generated continuous oscillations to give beats, at least not to any very great extent. On the other hand, in the case of spark telegraphy every atmospheric discharge is heard as a tick or a click in the telephone.

Again, it is far more easy to exclude deliberate attempts at jamming, as the difference between the local frequency and signal frequency must be constant and within somewhat narrow limits to give audible beats. In Figs. 139, 140, and 141 are given diagrams, due to Mr. J. Scott-Taggart, for C.W. reception. The arrangement in Fig. 141 is useful to obviate interference from spark-transmitters. For this purpose the aerial is very loosely coupled with the receiving circuits.

The diagrams in Figs. 139 and 140 are taken from an article by Mr. J. Scott-Taggart on "The Valve as an Amplifier," which appeared in the *Wireless World* for March, 1918, and May, 1919, and the diagram in Fig. 141 from an article by the same author in the *Wireless World*, entitled "Practical Notes on the Use of Small-power Continuous Wave Sets," which appeared in May and June, 1919.

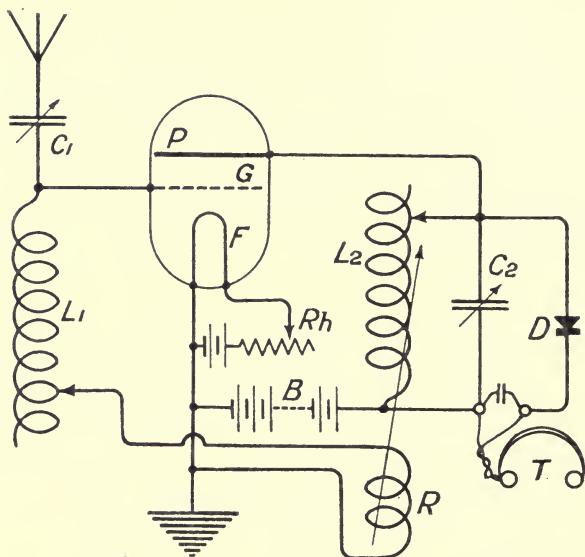

FIG. 139.—Thermionic Reception Set for C.W. Signals, employing a Crystal Detector, *D*, for detecting the beats.

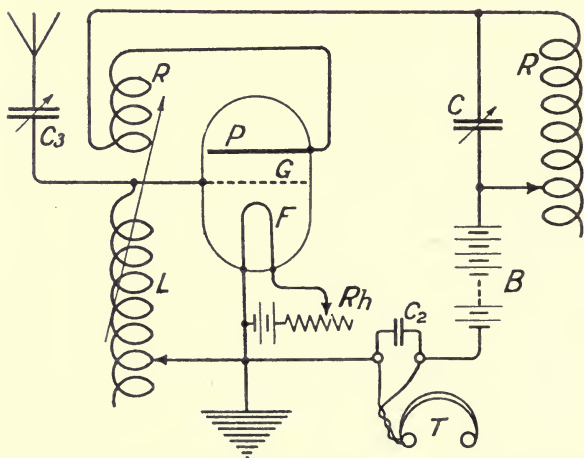

FIG. 140.—A Thermionic Reception Set for C.W. Signals.

5. We shall conclude this chapter by a few notes and references to recent theoretical investigations on the thermionic valve as detector and oscillator.

In many investigations it is necessary to bear in mind the difference between the true mean (T.M.) value, the root-mean-square (R.M.S.) value, and the first maximum instantaneous value, in the case of damped intermittent oscillations. The instantaneous value of a damped oscillation is represented mathematically by an expression of the type $Ie^{-at} \sin pt$, where t is the time, $p=2\pi n$, and

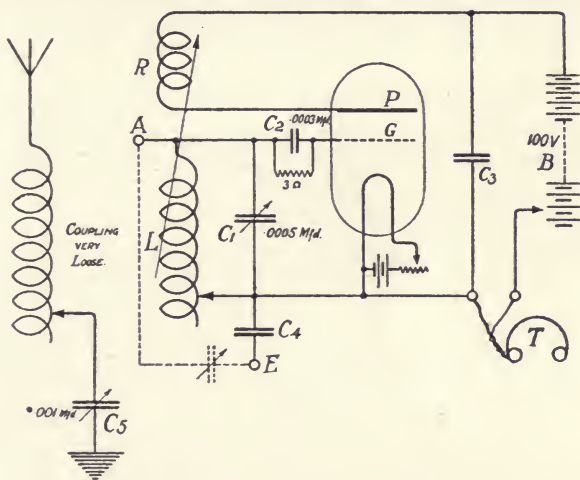

FIG. 141.—Thermionic Reception Set for C.W. Signals, with very loosely coupled Aerial to avoid interference by spark system Stations in proximity.

n is the frequency, also $\alpha=2n\delta$, where δ is the decrement per semi-oscillation, and I is the amplitude of the first oscillation, assuming that there is no sensible damping in the first quarter-period. If we suppose N trains per second of such oscillations to be sent through a hot-wire ammeter the current that will be read on the instrument is the root-mean-square value of these oscillations, and this is equal to the square root of the integral

$$I^2 N \int_0^{\infty} e^{-2at} \sin^2 pt \, dt.$$

It is easy to show that this R.M.S. value is equal to

$\sqrt{\frac{N}{8n\delta}}$ of the first maximum value, or that

$$I = \sqrt{\frac{N}{8n\delta}} \times \text{R.M.S. value.}$$

This relation holds good for damped oscillations of potential as well as of current.

Thus, for instance, if damped oscillations are taking place in a condenser, and if an electrostatic voltmeter applied to the terminals reads a R.M.S. voltage (V), the potential difference really rises to $\sqrt{\frac{N}{8n\delta}} \times (V)$ in the first oscillation.

Therefore, if the semi-period decrement $\delta=0.1$, and if $n=5 \times 10^5$, corresponding to a wave length of 2,000 feet, and if the spark frequency is 400, we have $\sqrt{\frac{8n\delta}{N}}=32$ nearly.

Hence, if the R.M.S. voltage was 0.1 volt, it would mean that the first oscillation of each train reached a value of 3.2 volts nearly.

The above is important in connection with rectification of currents by a simple Fleming valve.

It has been pointed out that if we draw the characteristic curve of such a valve obtained by applying measured voltages in the external circuit connecting the plate with the negative end of the filament, we do not obtain an absolutely zero current when this impressed voltage is zero. We have to apply a small negative or reversed voltage of about 0.5 to 1.0 volt to reduce the current to zero. In other words, the characteristic curve does not start from the zero of impressed voltage, but from a point about 0.5 to 1.0 volt on the negative side. It has therefore been contended that the Fleming valve does not rectify for very small impressed voltages, and it has been sometimes deemed necessary to rest the explanation of the action of a Fleming valve as a detector in wireless telegraphy upon a change in slope of the characteristic curve at the place where it crosses the ordinate through zero voltage. This, however, is not always necessary if we bear in mind that when em-

ploying damped oscillations there may be a very great difference between the R.M.S. value of the potential difference at the terminals of a condenser in a receiving circuit and the maximum value of that potential oscillation.

Thus, for instance, suppose the R.M.S. potential difference at the terminals of the condenser in a receiver actuated by spark signals was 0.1 volt (and it may often be a great deal more), the first maximum potential difference in each oscillation may amount to 2 to 4 volts or more, according to the decrement, frequency of spark, and wave length. Accordingly, for the greater part of each train of oscillations the potential amplitude would be such that the current through the valve would be absolutely zero for one direction of oscillation in the train.

Hence the valve would rectify in quite the ordinary acceptance of the term, and there is no necessity to fall back upon any other explanation of its operation as a detector.

We pass on then to consider some points in the theory of the three-electrode valve, which we owe particularly to the study of it made by G. Vallauri, H. J. Van der Bijl, S. Ballantine, J. M. Miller, and others.*

We have already seen that in a three-electrode thermion the plate current, i_p , is a function of the grid potential or voltage v_g and of the plate potential or voltage, v_p . Hence the connection of the three variables can be represented by a surface called the *characteristic surface*, and sections of this surface are called *characteristic curves*.

Irving Langmuir has given the equation to this surface in the form—

$$i_p = A (v_p + kv_g)^{3/2} \quad . \quad . \quad . \quad (1)$$

Where k is a constant depending upon the particular construction of the tube and grid and plate.

In investigating the behaviour of the thermion experimentally, it has been usual to consider curves which are

* * See G. Vallauri *Estratto dal Giornale L'Elettrotecnica*, January 25th, February 5th, 1917. H. J. Van der Bijl, *Theory and Operating Characteristics of the Thermionic Amplifier*; *Proc. Institute of Radio-Engineers, New York, U.S.A.*, Vol. 7, April, 1919, p. 97. Ditto S. Ballantine, p. 129; and J. M. Miller, *A Dynamic Method of determining the Characteristics of the Three-Electrode Vacuum tube*; *Proc. Institute of Radio-Engineers*, Vol. 6, June, 1918, p. 141.

sections of the characteristic surface, taking either grid potential v_g as constant or plate potential v_p as constant.

About a certain region this characteristic surface is almost a plane, and the equation of it in that region has been given by Vallauri as—

$$i_p = av_g + bv_p + c \quad . \quad . \quad . \quad . \quad (2)$$

Hence it is clear that if the plate voltage is kept constant, the slope of the characteristic curve is $di_p/dv_g = a$, and if the grid voltage is kept constant the slope of the characteristic curve is $di_p/dv_p = b$. Both a and b are of the dimensions of a conductance. Accordingly there are two principal characteristic curves—viz., the plate-current grid-potential curve, and the plate-current plate-voltage curve. The slope of the first is a , and that of the second is b , for the region where the surface is nearly plane.

The two quantities, a and b , are fundamental in determining the behaviour of the thermion as an amplifier and oscillator.

Their ratio, a/b , is the same quantity as the k in Langmuir's equation (1). The quantity $1/b$ is the internal resistance of the bulb or vacuum in the plate circuit when traversed by the oscillations of the frequency used.

Van der Bijl has proposed another form of equation for the characteristic surface—viz. :

$$i_p = A(\gamma v_p + v_g + \epsilon)^2 \quad . \quad . \quad . \quad . \quad (3)$$

and it is obvious that his coefficient, γ , is a quantity of the same nature as the reciprocal of Langmuir's coefficient, k . Van der Bijl also employs a symbol, μ , for the reciprocal of γ , and this is then identical with Langmuir's k .

The quantity represented by a/b , μ or k , or $1/\gamma$ is important, and is called the *amplification factor or ratio* of the thermion.

Since $a = di_p/dv_g$ and $b = di_p/dv_p$, it follows that $a/b = dv_p/dv_g$. Hence the amplification factor is the slope of the curve formed by plotting plate voltage or potential in terms of grid potential.

The importance of this amplification factor is that it determines the value of the bulb as an amplifier of feeble radio-oscillations of potential, and its magnitude depends upon the relative distances of filament, grid, and plate, and

upon the closeness of the grid wires or mesh, also to some extent upon the filament temperature. Also it varies with the particular region of the characteristic surface in which operation takes place. It is therefore far from being a constant quantity, and is best called a *factor*.

The practical measurement of it for given conditions of working is important, and methods of doing this have been given both by J. M. Miller and by H. J. Van der Bijl (*loc. cit.*).

A second important quantity is that called the *internal resistance* or *impedance* of the tube (R_i). This is the ratio of small increments of plate voltage or potential to plate current—viz., dv_p/di_p . It is denoted by the symbol, R_i .

At low frequencies this impedance is a pure resistance, and may range from 5,000 to 500,000 ohms.

Methods for its measurement have been suggested by Bijl and Miller.

The first of these is based on the assumption that the characteristic is nearly a straight line at the central portion, and that the internal impedance is the slope of the direct current characteristic. A useful theorem has been suggested by H. H. Belty as follows :—

Let I_p be the direct current component of the plate current, and i the alternating current component. Then the total plate current, $i_p = I_p + i$.

Let E_g be the voltage of the grid battery and e_g the alternating potential impressed on the grid. Then the total grid potential, $v_g = E_g + e_g$.

Let E_p be the voltage of the plate battery, and let $x + jy$ be the impedance of a coil inserted in the plate circuit which has a direct current resistance, x' . Then the resultant plate voltage, $v_p = E_p - I_p x' - i(x + jy)$.

But by Vallauri's equation we have—

$$i_p = av_g + bv_p + c \quad . \quad . \quad . \quad (1)$$

and substituting the values above for i_p , v_g and v_p , we obtain the equation—

$$I_p + i = a(E_g + e_g) + b(E_p - I_p x' - i(x + jy)) + c \quad (2)$$

But the steady current,

$$I_p = a E_g + b(E_p - I_p x') + c \quad . \quad . \quad . \quad (3)$$

Hence by subtraction we find—

$$i = a e_g - bi(x + jy) \quad . \quad . \quad . \quad (4)$$

THE THERMIONIC VALVE IN

or
$$\frac{a}{b} e_g = i \frac{1}{b} + i(x + jy) \quad . \quad . \quad . \quad (5)$$

or
$$k e_g = i R_i + i(x + jy) \quad . \quad . \quad . \quad (6)$$

or
$$k e_g = i \{ R_i + x + jy \} \quad . \quad . \quad . \quad (7)$$

This last equation is the expression for a current, i , flowing in a circuit of impedance, $R_i + x + jy$, under an impressed E.M.F. = ke_g . Accordingly the alternating part of the plate current is that current which would flow in a circuit of impedance equal to that of the valve plate circuit under an E.M.F. k -times that alternating voltage impressed on the grid. Hence the suitability of the term amplification factor for the quantity k .

Thus, for instance, suppose we have two identical amplifiers connected in cascade by resistance coupling, and that we have in the plate circuit of the first valve a high resistance, R , and from the ends of this resistance connections taken respectively to the grid and filament of the second valve. Let e_g be the alternating voltage impressed on the grid of the first valve. Then $ke_g = i(R_i + R)$, where R_i is the internal resistance of each valve. But iR is the A.C. potential impressed on the grid of the second valve. Hence we have—

$$\frac{iR}{e_g} = k \frac{R}{R_i + R} \quad . \quad . \quad . \quad (8)$$

Again, for the second valve we have, if i^1 is its plate current,

$$kiR = i^1 (R_i + R) \quad . \quad . \quad . \quad (9)$$

and the P.D. at the terminals of the resistance, R , in the second valve plate circuit is $i^1 R$. Accordingly, from the last two equations—

$$\frac{i^1 R}{e_g} = \left(\frac{kR}{R_i + R} \right)^2 \quad . \quad . \quad . \quad (10)$$

Hence the voltage amplification for n similar valves so coupled in cascade is—

$$\left(\frac{kR}{R_i + R} \right)^n \quad . \quad . \quad . \quad (11)$$

J. M. Miller has given a simple method of measuring the quantities k and R_i for any valve as follows:*

* See *Proceedings of the Institute of Radio-Engineers*, of New York. Vol. 6, p. 144, June, 1918.

An alternating voltage having a frequency of 1,000 to 2,000 is applied to the ends of a potentiometer wire, $c d$, having a sliding contact (see Fig. 142). One end of this potentiometer wire is connected to the grid of the valve through a grid battery, and the shifting contact to the filament. The plate is connected to the other end of the potentiometer through a plate battery and telephone, and a variable resistance R from 0 to 10,000 ohms is inserted as shown. A key, K , is placed in series with this resistance. Let r_1 and r_2 be the resistances of the two sections of the potentiometer wire, and with the switch open let the contact point be shifted until no sound is heard in the telephone. Then if A is the alternating current flowing in the potentiometer wire,

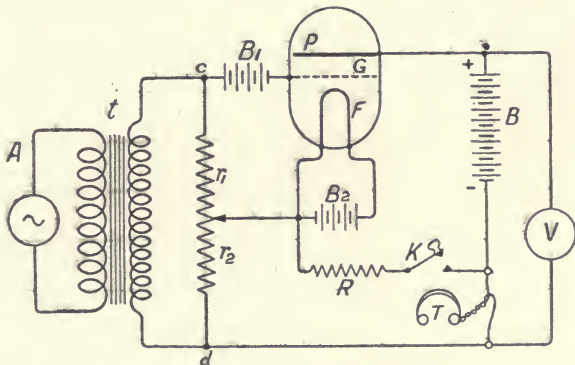

FIG. 142.—Method of J. M. Miller for Measuring the Amplification Factor μ and internal resistance of a Thermionic Valve.

meter wire, $r_1 A$ is the alternating potential applied to the grid and $r_2 A$ is the alternating E.M.F. in the plate circuit. Hence we have—

$$k = \frac{r_2}{r_1} \quad \dots \quad (12)$$

To determine the internal resistance, R_i , of the valve we put the slider at the middle of the potentiometer wire, and then vary the resistance, R , until no sound is heard in the telephone when the switch, S , is closed. Then, if A is the A.C. current in the potentiometer wire, the potential, e_g , applied to the grid is $r_1 A$, and the current in the plate circuit is therefore equal to $\frac{kr_1 A}{R_i + R}$, and the potential drop down the

resistance, R , is $\frac{kr_1AR}{R_i+R}$, since no current flows through the telephone. But this last P.D. is balanced by the fall in potential, r_2A , down the potentiometer wire. Hence—

$$\frac{r_2}{r_1} = \frac{kR}{R_i+R} \quad . \quad . \quad . \quad (13)$$

If, then, $r_2=r_1$ we have $R_i=(k-1)R$.

If the amplification factor, k , and the internal resistance, R_i , are thus measured with various values of the plate circuit impressed E.M.F. we can set them out in the form of curves as in Fig. 143, which is taken from J. M.

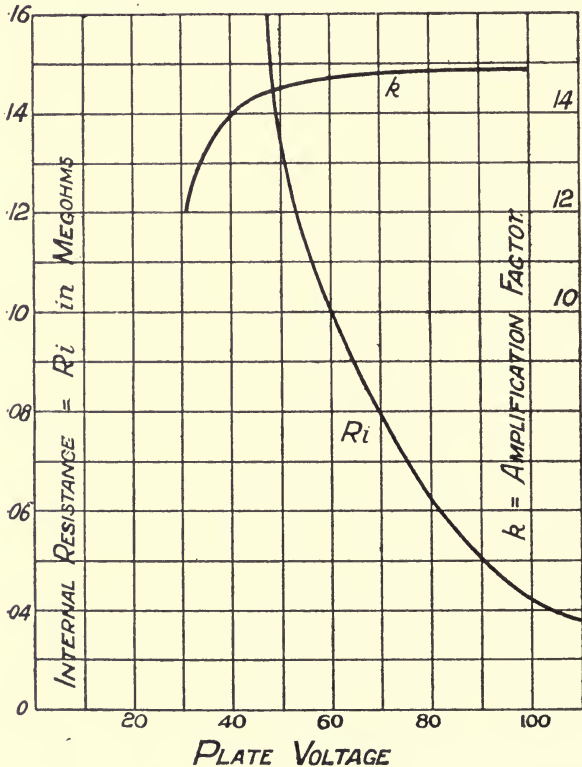

FIG. 143.—Curves representing the Variation of Amplification Factor k , and Internal Resistance R_i , of a Thermion.

Miller's paper (*loc. cit.*). Furthermore, we can determine from them the value of the quantity called by Hazeltine the *mutual conductance* of the grid and plate circuit.* It would be better to call it the *characteristic slope* of the thermion. For we have seen that if v_g is the resultant grid potential and v_p is that of the plate, then $k = dv_p/dv_g$, and also $R_i = dv_p/di_p$, where i_p is the plate current. Hence $k/R_i = di_p/dv_g$. But this last is the slope of the curve which defines the relation of plate current to grid voltage, and is Hazeltine's mutual conductance, which he denotes by the letter g .

A method of measuring the mutual conductance directly has been devised by Stuart Ballantine (see *Proc. Institute of Radio Engineers*, Vol. 7, p. 129, April, 1919, "On the Operational Characteristics of Thermionic Amplifiers").

It is clear, however, that the mutual conductance, g , the amplification factor, k , the internal resistance, R_i , and Vallauri's factors, a and b , are connected with one another as follows :

$$\frac{a}{b} = k; R_i = \frac{1}{b}; \frac{k}{R_i} = a \text{ or } g$$

Accordingly, we can take the parameters of the three-electrode valve to be k , R_i , and a .

The quantity R_i is measured in ohms, the quantity a is of the dimensions of a conductance, and is measured in ohms, and the quantity k is a mere numeric.

We shall conclude this chapter by considering the conditions under which a three-electrode thermion with mutually inductive grid and plate circuits can set up self-sustained undamped oscillations. Consider the scheme of circuits in Fig 144, where B_1 is the filament battery.

Let L_1 and L_2 be the inductances of the grid and plate circuits, and M their mutual inductance, and R the resistance of L_1 , and C the capacity shunted across it. Then if, as above, i_p is the plate current and e_g the grid alternating voltage, and i the current in the oscillation circuit, L_1 , R , C , we can then write down the two differential equations of E.M.F. for the grid and plate circuit as follows :

* See L. A. Hazeltine on "Oscillating Audion Circuits." *Proc. Institute of Radio Engineers*. Vol. 6. p. 63, 1918. See also Chapter IV of this book.

THE THERMIONIC VALVE IN

$$L_1 \frac{di}{dt} + Ri + \frac{1}{C} \int i dt + M \frac{di_p}{dt} = 0 \quad . \quad . \quad (14)$$

$$L_2 \frac{di_p}{dt} + R_i i_p + M \frac{di}{dt} + \frac{k}{C} \int i dt = 0 \quad . \quad . \quad (15)$$

Also we have—

$$e_p = k e_g = \frac{k}{C} \int i dt \quad . \quad . \quad . \quad (16)$$

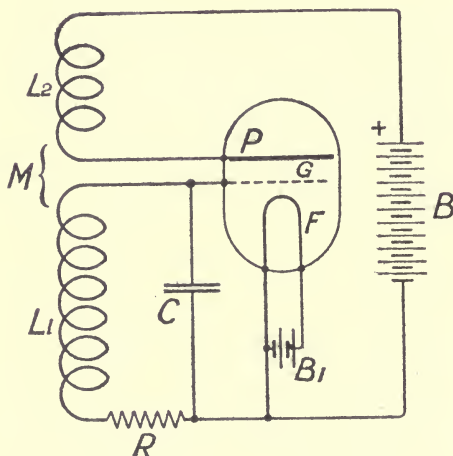

FIG. 144.—Typical Thermionic Circuits for Auto-production of Oscillations.

Eliminating e_p and i_p from these equations (14) and (15), by differentiation, after substitution from (16), we have the equation (17) for the oscillatory current, i , in the L_1, R, C , circuit as follows :

$$(L_1 L_2 - M^2) \frac{d^3 i}{dt^3} + (R L_2 + R_i L_1) \frac{d^2 i}{dt^2} + \frac{(R R_i C + L_2 - k M)}{C} \frac{di}{dt} + \frac{R_i}{C} i = 0 \quad . \quad . \quad . \quad (17)$$

This equation is of the type—

$$\alpha \frac{d^3 i}{dt^3} + \beta \frac{d^2 i}{dt^2} + \gamma \frac{di}{dt} + \delta i = 0 \quad . \quad . \quad (18)$$

The last equation (18) can be written in the form—

$$\frac{d}{dt} \left(\alpha \frac{d^2 i}{dt^2} + \gamma i \right) + \left(\beta \frac{d^2 i}{dt^2} + \delta i \right) = 0 \quad . \quad . \quad (19)$$

We require to find the conditions under which the current, i , will be an undamped oscillation. This implies that there must be a solution of (19) in the form $i = A \epsilon^{jpt}$.

One solution that satisfies the equation (19) is that the pair of equations (20), viz. :

$$\frac{d^2 i}{dt^2} + \frac{\delta}{\beta} i = 0, \text{ and } \frac{d^2 i}{dt^2} + \frac{\gamma}{\alpha} i = 0 \quad . \quad . \quad . \quad (20)$$

shall be simultaneously satisfied. Because if these are simultaneously satisfied by a certain value of the current, i , the differential equation (18) of the third order is also satisfied.

These two last equations (20) are both satisfied by an expression of the form, $i = A \epsilon^{jpt}$. Hence they denote undamped oscillations which have identical frequency, provided we have—

$$p = \frac{\delta}{\beta} = \frac{\gamma}{\alpha} \text{ or } \alpha : \beta = \gamma : \delta$$

Therefore, substituting the full expressions equivalent to $\alpha, \beta, \gamma, \delta$, we have, as the condition of the establishment of undamped oscillations in the valve circuits, that—

$$\frac{R_i}{R R_i C + L_2 - kM} = \frac{R L_2 + R_i L_1}{L_1 L_2 - M^2} \quad . \quad . \quad . \quad (21)$$

Now R_i is the internal resistance of the bulb, and is always very large compared with any possible value of R , whilst L_1 and L_2 are of the same order. Hence $R L_2$ can be neglected in comparison with $R_i L_1$, and the equation (21) reduces to

$$M^2 - k L_1 M + C R L_1 R_i = 0 \quad . \quad . \quad . \quad (22)$$

But we have seen that $k = a/b$ and $R_i = 1/b$, where a is the mutual conductance of the plate and grid circuits, or the slope of the characteristic curve delineating plate current in terms of grid potential. Accordingly (22) becomes—

$$a = \frac{M}{L_1 R_i} + \frac{C R}{M} \quad . \quad . \quad . \quad . \quad . \quad . \quad (23)$$

The quantity a , or characteristic slope, must lie between a certain maximum value at the centre of the curve and a

zero value at the point where the plate current reaches its saturation value.

Equation (23) is a quadratic in M . If we write it out and solve it we have—

$$M^2 - L_1 R_i a M + C R L_1 R_i = 0 \quad . \quad . \quad . \quad (24)$$

or
$$M = \frac{L_1 R_i a}{2} \pm \sqrt{\left(\frac{L_1 R_i a}{2}\right)^2 - C R L_1 R_i} \quad . \quad (25)$$

If $a=0$, then it is clear that M becomes imaginary and therefore impossible.

If $a = 2\sqrt{\frac{CR}{L_1 R_i}}$, then $M = \sqrt{C R L_1 R_i} \quad . \quad . \quad (26)$

and for no value of a or M less than these will the oscillations be set up and sustained.

There is therefore a minimum inductive coupling of the plate and grid circuits below which the persistent oscillations are not produced.

When they are produced their frequency, n , can be determined from the constants, C , R and L_1 , of the oscillation circuit by the formula—

$$n = \frac{1}{2\pi} \sqrt{\frac{1}{L_1 C} - \frac{R^2}{4L_1^2}} \quad . \quad . \quad . \quad (27)$$

and the corresponding wave length, λ , in metres is given by $(3 \times 10^8)/n = \lambda$.

A numerical example may make the use of these formulæ clearer. Suppose we employ a thermion of which the internal resistance, R_i , has been determined to be 15,000 ohms for a plate voltage of 60 volts. Let the resistance of the oscillating grid circuit be 25 ohms and its inductance, $L_1=65$ microhenrys. If we wish to set up oscillations corresponding to a wave-length of 200 metres it is required to find the capacity in the grid circuit and the mutual inductance of the grid and plate circuit to achieve this result.

We have $\lambda=200$ metres ; therefore $n=(3 \times 10^8)/200=1.5 \times 10^6$. Then from (27) $C = \frac{1}{5,772} \text{ mfd}$. Hence the least value of M must be by (26) 64 microhenrys.

Furthermore, since it is not in general practicable to use a closer coupling $\left(\frac{M}{\sqrt{L_1 L_2}}\right)$ than 0.5 it follows that L_2 must

have some such value as 250 microhenrys to fulfil this condition.

It will therefore be seen that the parameters, k , R_i and a , are most important constants or characteristics of any particular three-electrode valve, and should be given by the maker of it in the form of curves set out in terms of plate battery voltage.

There is yet a large amount of research to be done in connecting together the effect of various types of valve construction with the magnitude of these coefficients to enable thermionic valves, amplifiers and oscillators to be designed with certainty for various purposes.

The author trusts that some of the information given in this treatise may be of assistance to research workers in grappling with these practical problems.

In connection with the use of the thermionic valve as an oscillation generator, an important decision has lately (July 7th, 1919) been handed down by District Judge Mayer in a Judgment given in the United States District Court for the Southern District of New York, in an action brought by the Marconi Wireless Telegraph Company of America against the De Forest Radio Telephone and Telegraph Company, having reference to the use of the valve as a generator of oscillations. In this Judgment it has been declared that the Claim 1. of the Fleming United States Patent No. 803,684 for the thermionic oscillation valve, covers its use not only as a radio-detector but as an oscillation generator. It has been judicially held in more than one case that if a particular device has an inherent capacity of reversibility so that it can operate in either sense, a patent claim for the instrumentality must be considered to cover its use not only in one described manner but also in the reverse direction, though the latter may not have been definitely ascertained until after the date of the patent.

APPENDIX

UNITED STATES DISTRICT COURT

SOUTHERN DISTRICT OF NEW YORK.

| | |
|--|----------|
| MARCONI WIRELESS TELEGRAPH COMPANY OF AMERICA, Plaintiff, <i>against</i> | } F12-31 |
| DE FOREST RADIO TELEPHONE AND TELE- GRAPH COMPANY and LEE DE FOREST, Defendants. | |

In Equity. Suit for infringement of Claims 1 and 37 of U.S. Letters Patent No. 803,684, for "Instrument for Converting Electric Currents into Continuous Currents," filed April 19th, 1905, and issued November 7th, 1905, to plaintiff as assignee of John Ambrose Fleming of London, England.

Counterclaim by defendants on various claims of ten patents of Lee de Forest.

At the opening of the trial plaintiff confessed judgment as to Claims 4 and 6 of U.S. Letters Patent No. 841,387, and defendants withdrew from issue Claim 5 of the same patent. Plaintiff also confessed judgment as to the claims in issue of U.S. Letters Patent No. 879,532 and defendants withdrew U.S. Letters Patent No. 837,901. Of the counterclaim there remain in issue certain claims of seven patents as follows:

| Number. | Claims. | Filed. | Issued. |
|------------|----------------------|--|---------------|
| 979,275—8, | 16, 20, 29, and 35 | Feb. 2, 1905 | Dec. 20, 1910 |
| 867,876—3, | 4, 5, 6, 7, 14, 18 | { Orig. Feb. 2, 1905 Div. Apl. 4, 1906 | Oct. 8, 1907 |
| 867,877— | 4 | { Orig. Feb. 2, 1905 Div. June 12, 1907 | Oct. 8, 1907 |
| 867,878— | 2 | { Orig. Feb. 2, 1905 Div. June 12, 1907 | Oct. 8, 1907 |
| 824,637— | 8 | Jan. 18, 1906 | June 26, 1906 |
| 836,070—5, | 6, 7, 8 | { Orig. Jan. 18, 1906 Div. May 19, 1906 | Nov. 13, 1906 |
| | | Aug. 27, 1906 | Jan. 15, 1907 |
| 841,386—1, | 2, 3, 13, 15, 20, 21 | | |

SHEFFIELD & BETTS (J. EDGAR BULL, RAMSAY HOGUET and L. F. H. BETTS, of Counsel), all of New York City, for Plaintiff;
PHILIP FARNSWORTH, GEORGE F. SCULL and SAMUEL E. DARBY, all of New York City, for Defendants.

RADIOTELEGRAPHY AND TELEPHONY

MAYER, District Judge :

Whatever differences may exist between men of science in respect of the theories by which they account for the movement and action of the unseen forces about which so much has been testified and argued in this case, the solution of the points of the controversy with a single exception is not difficult. This, because courts, in an art of this kind, place their decisions upon things demonstrable and cannot speculate as to theories in regard to which there is not a common agreement among recognised authorities.

In endeavouring to resist plaintiff's attack, defendants have proceeded on the theory that beginning with his parent patent No. 979,275 antedating Fleming, de Forest gradually developed his first conception until finally it found practical exemplification in the two so-called three-electrode "Audion" devices as to which plaintiff has confessed judgment. In line with this plan of defence, defendants have elaborately built up an unsteady theoretical structure and upon this have superimposed an observatory from which they can see in the mind's eye only that which they call "Audion" action. Therefore, in these circumstances, it is desirable, in order to avoid confusion, to consider first the patents in issue, and, then, the question of infringement; for when their true value is assigned to the patents, the controversy as to infringement will be better understood. The patents deal with those instrumentalities which, in the art, are aptly named detectors.

"The purpose of the detector," as explained in simple language by Waterman, plaintiff's expert, "is to enable some indicating instrument to respond to and thus reveal the presence of the high-frequency oscillatory currents which are the result in the receiving system of the transmission of the wireless waves. These wireless waves are of the same nature as light, but are of greater wave-length. We have sense organs for perceiving ether waves of the length known as light, also sense organs for perceiving that range of wave-lengths known as radiant heat, but we have no means of detecting ether waves of those lengths which are employed in wireless telegraphy, and it is therefore necessary that their presence should be detected and indicated to us through some means that we can perceive. A wireless telegraph transmitter is thus a sort of lighthouse, which emits light of an invisible nature, and the receiver must furnish the eye to detect the waves which are emitted. . . .

"If we go back for the moment to the figure of the lighthouse, we see that if we think of light sent out from it, then the receiving antenna casts a shadow. The energy which it receives corresponds to that shadow, just as when a material object casts a shadow of light it absorbs the energy of the light which it intercepts, so that receiving antenna absorbs the minute amount of energy which it intercepts in the moving wave.

"On account of their excessive frequency and minute energy, the oscillatory charges which are set up in the receiving antenna are not, generally speaking, able to affect directly any known measuring or indicating apparatus. They therefore must make their presence felt indirectly, by producing some local effect which will permit of a signalling or indicating apparatus to be operated, in accordance with a sufficiently definite code so that intelligible signals may be sent. Hence a detector, as the term is used in wireless telegraphy, is a means of causing the oscillations to produce or vary a local current, in accordance with variations of the waves produced at the sending station, and of such a character that an indicating instrument can respond to them." (See also Pierce's *Principles of Wireless Telegraphy*, 1910, p. 142.)

THE THERMIONIC VALVE IN

As the practical radio art developed, there was a constant effort to improve the detector in three directions; first and most important, in sensitiveness to received signals; secondly, in reliability, and, thirdly, in ease of manipulation by the receiving operator.

There were many types of detectors prior to Fleming, the most useful of which were known as the coherer, the microphone, the magnetic, the electrolytic, and the crystal.

Some detectors, such as that of Hertz and the hot-wire barreter of Fessenden, were never of any commercial utility and may be disregarded.

The coherer was in standard use for a fairly long period. It consisted of a glass tube with metal filings, and its operation was caused by the cohering of the filings due to high-frequency oscillations, thus transforming a practically non-conducting device into a conductor and permitting a local battery current. The coherer lacked sensitiveness to feeble waves and required to be shaken or otherwise moved to restore the contact to its sensitive condition after the receipt of a signal. (See Pierce, *supra*, pp. 143 *et seq.*)

The microphone consisted of a loose contact of two terminals preferably dissimilar in character such as carbon and steel and operated by reason of a change of contact resistance effected by the incoming oscillations. This device was used both with and without a local battery. Its failure to attain any large commercial use was due to the delicacy and difficulty of adjustment.

Of the magnetic detectors that of Marconi was widely used and displaced the coherer. This magnetic detector consists, in substance, of a moving band of soft iron passing in front of two magnets which magnetise the iron. A coil is so connected to the antenna that the oscillations demagnetise the iron band and are thus detected. Although still useful because of simplicity of operation and indifference to static discharges, this type lacked the keen sensitiveness which has become so important to the increasing usefulness of the art.

The electrolytic consisted of a cell containing an electrolyte (usually 20 per cent. nitric acid, but, in any event, any electrolytically conductive liquid such as common salt solution, dilute sulphuric acid or caustic soda) and having two immersed electrodes. One form was the Shoemaker cell, where the two elements were dissimilar and another was where the elements were of the same material, such as fine platinum wire. In the first form a local battery was not used while in the second it generally was. Though this detector was highly sensitive, it was extremely difficult of adjustment especially on shipboard and the fine wire was liable to be burned out by strong signals or static discharges.

The crystal detector invented by Bose opened up a new line of experiment and investigation to which, among others, General Dunderwood, of the United States Army (retired), defendant's expert Pickard, and Pierce of Harvard, later (and after the Fleming date) made valuable contributions. Detectors of this class consist of a self-restoring high resistance between solid bodies, one of which is usually crystalline in character, such as carborundum and molybdenite. The operation depends upon the phenomenon that when a contact is made with certain crystals current will flow more easily in one direction than another.

The crystal detector, particularly because of ruggedness of material, is still in extensive use, but, as is generally accepted and was fully demonstrated in the court room, it is somewhat unsatisfactory by the reason of the necessity of taking time to feel around, as it were, sometimes for a sensitive point and sometimes for the best point on the

RADIOTELEGRAPHY AND TELEPHONY

crystal and the liability that such a point may be destroyed or its sensitiveness impaired by a strong incoming signal, by static, or by the local sending station.

These criticisms or defects of one kind or another in the detectors prior to Fleming—or since, for that matter—will be fully appreciated when it is realised that efficiency in this art consists in attaining accuracy and quickness in reception of signals as well as distance, whether the radio message is across the ocean from one merchant to another, from a vessel in distress calling for help from land or sea, or from a naval officer to the ships under his command.

With the state of the art as briefly outlined, *supra*, John Ambrose Fleming disclosed the incandescent lamp detector. While the United States patent application was filed April 19th, 1905, the effective date is that of the British specification filed November 16th, 1904.

Fleming is a British scientist of the highest standing, and, as appears from his patent, and his papers read before learned societies, is and long has been recognised as a man of major accomplishments with the ability to make clear what he intends to convey.

Stripped of technical phraseology, what Fleming did was to take the well-known Edison hot and cold electrode incandescent electric lamp and use it for a detector of radio signals. No one had disclosed nor even intimated the possibility of this use of a device then long known in another art. Cohering filings, magnets, electrolytes, and sensitive crystals, *at that time*, failed to give any hint of the utility in this art of the Edison lamp.

What led Fleming to his result was his adherence to the theory of the “rectified” alternating currents. In his patent specification he put his proposition thus:

“This invention relates to certain new and useful devices for converting alternating electric currents, and especially high-frequency alternating electric currents or electric oscillations, into continuous electric currents for the purpose of making them detectable by and measurable with ordinary direct-current instruments, such as ‘mirror-galvanometer’ of the usual type or any ordinary direct-current ammeter. Such instruments as the latter are not affected by alternating electric currents either of high or low frequency, which can only be measured and detected by instruments called ‘alternating-current’ instruments of special design. It is, however, of great practical importance to be able to detect feeble electric oscillations, such as are employed in Hertzian-wave telegraphy by an ordinary movable coil or movable needle mirror-galvanometer. This can be done if the alternating current can be ‘rectified’—that is, either suppressing all the constituent electric currents in one direction and preserving the others or else by changing the direction of one of the sets of currents which compose the alternating current so that the whole movement of electricity is in one direction. . . .

“I have discovered that if two conductors are inclosed in a vessel in which a good vacuum is made, one being heated to a high temperature, the space between the hot and cold conductors possesses a unilateral electric conductivity, and negative electricity can pass from the hot conductor to the cold conductor, but not in the reverse direction. As the hot conductor should be heated to a very high temperature—say, near to the melting-point of platinum (1,700 deg. C.)—it should be of carbon, preferably in the form of a filament such as is used in any ordinary incandescent electric lamp. The cold conductor may be of many materials; but I prefer a bright metal, such as platinum or aluminium or else carbon. The two conductors are enclosed in a glass bulb similar to that of an incandescent lamp, and

THE THERMIONIC VALVE IN

I generally heat the carbon filament to a high state of incandescence by a continuous electric current, the electrical connection to the filament and the cold conductor being made by platinum wires, sealed air-tight through the glass."

He clearly described the necessity for a high degree of vacuum and a highly incandescent filament. (Fleming patent, p. 1, line 96; p. 2, line 5.)

In his lecture before the Royal Society, read February 9th, 1905 (*Proc. Roy. Soc.*, vol. lxxiv., particularly pp. 477, 481-485; also see Waterman's Test, p. 1083, *et seq.*), he described the mode of operation of his device, making equally clear what he had set forth in his patent specification, and, further, illustrated his views by a sheet of "characteristic curves." The "characteristic curve" is a curve plotted between voltage applied to the detector and the current through the detector, resulting from the application of this voltage. It is obtained by connecting a circuit containing a battery and a galvanometer or ammeter and a resistance whereby the potential of the battery may be varied to the hot and cold elements of the detector. Connected across the detector is a voltmeter to measure the applied local battery voltage. I agree with plaintiff that this sheet disclosed to one skilled in the art everything necessary to obtain a complete knowledge of the operation of the device. It showed that as the incandescence of the filament increases, this detector device becomes more sensitive and logically, therefore, the device should be operated at a high degree of incandescence, obtainable by whatever were known means therefor. Why the device thus operates successfully to detect signals is not as yet surely understood, but that it does so operate is an unescapable fact.

Fleming called the operation "rectification," and held that, substantially speaking, the current will flow through the lamp in one direction only—*i.e.*, from the cold cylinder to the hot filament. In his 1905 lecture he said:

"Perfect rectifying power, however, does not exist. There is not an infinite resistance to movement of negative electricity from the metal cylinder to the hot filament through the vacuum, although this resistance is immensely greater than that which opposes the movement of negative electricity in the opposite direction. . . .

"Returning, then, to the vacuum valve, we may note that the curves in Fig. 3 show that the vacuum space possesses a maximum conductivity corresponding to a potential difference of about twenty volts between the electrodes, for the particular valve used. The interpretation of this fact may, perhaps, be as follows: In the incandescent carbon there is a continual production of electrons or negative ions by atomic dissociation. Corresponding to every temperature there is a certain electronic tension or percentage of free electrons. If the carbon is made the negative electrode in a high vacuum these negative ions are expelled from it, but they cannot be expelled at a greater rate than they are produced. Therefore, there is a maximum value for the outgoing current and a maximum value for the ratio of current to electromotive force—that is, for the conductivity."

NOTE.—Eccles in his *Handbook of Wireless Telegraphy and Telephony* defines "electron" as "The 'atom' of negative electricity, the smallest quantity of electricity known to take part in electrical phenomena."

Whether right or wrong in his theory, the result of Fleming's invention was to give the art a new, valuable, and easily obtainable detector, which has gone into important commercial use. This Fleming detector

is highly sensitive, quickly adjusted by an operator of even inferior skill and only momentarily disturbed by static or strong signals. The thoroughness and earnestness of this litigation is its most significant testimonial. Nothing in the prior art urged by defendants in negation of invention calls for extended discussion. The Tesla patent (No. 645,576) and the Fessenden patents (Nos. 706,742; 706,743, and 706,744) were far removed from the incandescent lamp and were commercially useless; and, nothing could be learned for this purpose from the Valbreuze and Zehnder tubes.

Rectifiers of low frequency oscillations, such as those of Wehnelt and Cooper-Hewitt, taught nothing. These are rectifiers for commercial power frequencies, and it was not common knowledge, as of Fleming's date, that rectifiers of low frequency oscillations would rectify radio waves, nor is it a fact that all rectifiers of low frequencies are likewise rectifiers of radio high frequencies. Further, it was not common knowledge, as of Fleming's date, that a rectifier of radio oscillations would act as a detector. For instance, Pickard first attributed the action of crystal detectors to thermo-electric effects, but when Pierce published his investigations in 1907 Pickard amended many of his patent applications to conform with Pierce's theory of rectification. (See Pierce *supra*, p. 162 and test of Pickard.)

In the absence of a well-accepted theory of operation which needed merely some physical embodiment, and, in the absence also in the art of the physical device itself at a time when men of great skill were constantly endeavouring to bring forth an advance in this branch of the art, the contribution of Fleming was clearly invention, and is entitled to liberal interpretation and consideration—unless impeded by de Forest.

This brings us to the parent patent of de Forest, No. 979,275, to which, on the evidence, the effective date of November 4th, 1904, must be accorded. Plaintiff is well justified in calling this and the divisional applications the Bunsen burner patents. Nowhere is there a suggestion of an incandescent electrode. On the contrary, in the specification and the drawings it is entirely apparent that de Forest pointed out only what the laymen understands as heating gas. This de Forest stated in language which sounds impressive. He said:

"I have discovered that if two bodies adapted for use as electrodes or conductive members be electrically separated, partially or wholly, after the manner common in analogous devices, the separation between them may be neutralised sufficiently to enable them to act as a detector of electrical oscillations, if the intervening or surrounding gaseous medium be put into a condition of molecular activity, such, for instance, as would be caused by heating it in any manner, as by radiation, conduction, or by the combustion of gases in the space which surrounds the poles. Such condition or molecular activity causes what would otherwise be a non-sensitive device to become sensitive to the reception of electrical influences. I am thus enabled to employ as such sensitive member devices which would otherwise be of no value, or to make those devices now used more sensitive to the electrical waves. This principle is embodied in the apparatus illustrated in the various figures shown."

Translated into plain English, this meant, "I will try to make the gas conductive between two electrodes by heating it to the dissociating point."

It was attempted to read incandescence into the specification, or rather to infer much that later knowledge has taught, but incandescence had long been a word of art, and Fleming had no trouble in using it either in his specification or his Royal Society paper. Why not de

THE THERMIONIC VALVE IN

Forest? Merely because the incandescent lamp detector was the farthest from his thoughts.

True, gas is a generic term of wide meaning, as is clear from the very beginning of J. J. Thomson's notable *Conduction of Electricity through Gases*; but when the language of a patent is to be interpreted the document must be construed as a whole just like any ordinary contract, and words cannot be isolated from their context to give them a more comprehensive meaning than was originally intended. What defendants have attempted is to establish that de Forest described in these patents ionisation by impact as distinguished from dissociation by flame and thus forestalled Fleming, on the hypothesis that de Forest was the first to realise the value and effect of electrode emission. No better confirmation of the negligible character—in this connection—and, perhaps, obscurity of the disclosure can be found than the testimony of Pickard, in answer to the Court's questions (Q. 925 *et seq.*).

An elaborate discussion, at this juncture, of electronic action might be interesting, for the subject is really fascinating, but it is unnecessary for the simple reason that the patent discloses merely the heating of the gas without any direction from which the most learned scientist of that day could have gleaned any further information.

In the divisional patent 867,876 the expression is used "this gas may be air or the electrodes may be enclosed," but how this device works is still to be explained, for the experiment at High Bridge with the Nernst lamp was not in accordance with the disclosure of the patents.

This burner detector of de Forest has never been commercially used and thus has not made any impression on the art. A mere inspection of the device in operation will show that this flickering flame is impractical. The most that can be said is that it may contain the germ of an idea which, in this rapidly progressing art, may hereafter be utilised in some way. While, therefore, it is not necessary to declare this patent and its three subsidiaries invalid they may be eliminated from this case for all practical purposes.

Before considering the patent No. 824,637 and its division No. 846,070, filed originally January 18th, 1906, it must be remembered that de Forest in December, 1905, knew of Fleming's Royal Society paper of March, 1905, as appears from a reference to that effect in his application for a certain patent not here in issue (No. 823,402) where he used the expressions exhausted "vessel" and "heated to incandescence." Further, on December 21st, 1905, he instructed his solicitor to "look out for Fleming's recent patent."

The point is that what in effect defendants urge *inter alia*, is that de Forest's idea of employing a local battery which has come to be known as Battery B, in any event, imparts invention to his patents and its use by plaintiff amounts to infringement, or, if that contention be not sustained, then finally defendants do not infringe.

With his knowledge of Fleming's theory, it should have been very easy to describe the incandescent lamp detector, plus Battery B, but, in 824,637 de Forest now had in mind a receptacle inclosing a gaseous conducting medium. He said:

"With these objects in view my invention comprises a receptacle enclosing a sensitive gaseous conducting medium, the conductivity of which does not necessarily depend upon the heat of combustion, although such conductivity may be increased by heat in said gaseous medium, and which in some cases requires practically no heating at all, a wave-intercepting means associated with said gaseous conducting medium, whereby the feeble electrical currents or oscillations resulting from the energy absorbed from electro-magnetic signal waves may be

impressed upon said gaseous conducting medium to alter its conductivity, and a signal-indicating device operatively connected with said gaseous conducting medium, whereby alterations in the conductivity of the latter may be made manifest."

The only possible reference to a vacuum is at p. 1, line 101-105, as follows :

"In all embodiments of the present invention the electrodes are enclosed and are surrounded by a *suitable gas*, and they may be enclosed in a receptacle which *may* be partially exhausted."

The only reference to incandescence is in one compound word at p. 2, line 4, as follows :

"In Fig. 1 two filaments C, which *may* be ordinary incandescent-lamp carbon filaments are sealed into the receptacle B . . ." (Note).

NOTE.—Italics mine.

These "mays" at best are meagre disclosures, but that these patents dealt only with the heated gas idea is clear from de Forest's correspondence with his solicitor in December, 1905, and January, 1906, from his ordering incandescent lamps from one McCandless in the same December and January, with his thereafter change of phraseology and tone (see No. 841,386, and his January 20th letter to his solicitor, "keep it dark, but the new receiver is the best yet"), but most convincingly from the patent itself.

According to Pickard's theory of ionisation by impact, there must be a source of electrons, but in this patent no electron producing nor impelling means are shown. On the contrary, Figs. 4, 5, and 6, show two cold electrodes, and referring to Fig. 4, de Forest specifically dispenses with both heated electrodes (p. 2, line 72), an inconsistency with defendants' theory, which cannot be reconciled. (XQ. 1,147, *et seq.*)

These patents (Nos. 824,637 and 836,070) were never of any commercial utility, and at best can be sustained only within the limits of their precise disclosures.

The so-called selective *per se* patent No. 841,386, is so utterly useless that it might well be declared invalid, but it will suffice in this suit to construe it as limited to a structure selective *per se*, and irrespective of any circuit connections.

It follows, of course, that plaintiff does not infringe any of defendants' patents and that the counterclaim will be dismissed.

We now come to what I think is the only substantial question in the case—the infringement claimed against defendants.

The Fleming patent was originally framed in rather broad language so that it might have been construed as applying to other than radio uses in addition to its use in the radio art. By disclaimer filed in the Patent Office, November 17th, 1915, plaintiff disclaimed the combination of Claims 1 to 6 inclusive, and Claims 10 to 15 inclusive, except as the same are used in the radio art, and to certain correlated words in the specification.

The claims selected to sue upon were Nos. 1 and 37 because typical. They read :

"1. The combination of a vacuous vessel, two conductors adjacent to but not touching each other in the vessel, means for heating one of the conductors, and a circuit outside the vessel connecting the two conductors."

"37. At a receiving station in a system of wireless telegraphy employing electrical oscillations of high frequency a detector comprising a vacuous vessel, two conductors adjacent to but not touching each other in the vessel, means for heating one of the conductors, a circuit outside of the vessel connecting the two conductors, means for detecting

THE THERMIONIC VALVE IN

a continuous current in the circuit and means for impressing upon the circuit the received oscillations." (Note.)

NOTE.—In construing Claim 37 it must be remembered that "continuous current" is used in its English sense of 1905 of a direct current, whether intermittent, varied, or not. (See also p. 2, line 109, of Fleming patent.) By a recent convention continuous current now means a direct current of unvarying value.

Claim 1, as limited by the disclaimer, is a broad claim for the incandescent lamp as a radio detector. Claim 37, in respect of which disclaimer was unnecessary, covers the detail applicable to a radio system—*i.e.*, a local circuit containing means for detecting a continuous (direct) current such as a telephone or galvanometer and means of impressing high-frequency oscillations on the detector, such as the secondary of the oscillation transformer.

Fleming's theory, as has already been stated, was that of rectification, while defendants account for the action of their "Audion" on the theory that it is a telephone relay or, in other words, that its products are alternating currents of "Audio" frequency and of the local energy and not of the "input" energy.

As a result of these differences the effect and relation of the local battery was one of the sharply contested points in controversy.

It was satisfactorily proved that for some reason not yet understood, incandescent lamps possess idiosyncrasies of operation, as demonstrated by a batch of a dozen lamps of identical dimensions made of identical stock, pumped at the same time for a vacuum and sealed at the same time. (Farrand's test; Waterman 1,244 and 1,820 *et seq.*)

Of these, some worked best at the negative end—*i.e.*, without a battery, some with a small amount of battery, some with a battery equal to the battery for lighting the filament and some with a battery in addition to that used for lighting the filament.

While, with care and time, lamps could be selected which would work best without a local battery, such a course would obviously be foolish commercially and unnecessary, when a simple and well-known means could be employed to utilise all the lamps, whatever their idiosyncrasies. This means was a local battery, and a potentiometer, whereby a varying local potential may be applied to the lamps. The potentiometer is a resistance connected across the lighting battery of the detector so that any fraction of the lighting battery may be tapped off and applied to the local circuit. The local battery is used to bring the lamp detector to the sensitive point of its characteristic curve and the potentiometer is the simple and effective device which, varying the local battery, accomplishes this task.

Nearly all prior art detectors were used in this way—the coherer of Marconi and Lodge, the microphone of Hughes and Branley, the electrolytic of Fessenden, Vreeland, and others, and the crystal of Bose. (Plaintiff's Exhibits 77 and 82.)

The use of the local battery to locate the sensitive point on the characteristic curve was well known and accepted as of Fleming's time and, as appears by his 1905 lecture, was fully understood by him. (See also particularly, Vreeland patent No. 780,842, Plaintiff's Exhibit 82.)

Plaintiff is undoubtedly entitled to use the Fleming detector with a well-known instrumentality, and, therefore, to employ the variable local battery; for practically all the prior art detectors required local batteries to locate the operating points. Plaintiff is likewise entitled to use the Fleming device in the ordinary detector circuits of the

prior art. The circuits of Marconi patent No. 627,650 are the specific circuits which plaintiff has used and the modern operative Fleming device has simply been substituted for the coherer in old and familiar circuits. (Q. 145, 146 *et seq.*)

Defendant's alleged infringing device is the so-called P. N. Type Audion de Forest Detector. Plaintiff's Exhibits 11 and 12 are drawings reducing to the simplest form the P. N. circuits and comparing Fleming with de Forest.

Waterman's description (in part) states in simple language plaintiff's view of this P.N. device as follows :

"The defendants' apparatus is an incandescent lamp detector of high-frequency oscillations for wireless telegraph purposes and consists of an incandescent lamp with the usual high vacuum, a filament, and a cold element, which in the particular construction here shown is divided into two portions, one a plate and the other a wire gridlike structure placed between the plate and the filament, both having leads brought out through the glass for exterior connection. . . ."

In the diagram of the Fleming patent there is missing the grid found in the de Forest structure.

"In other words, the two functions which are essential in the incandescent lamp detector—namely, impressing on the space the received oscillation and the detecting of what happens as a result, are performed by a single circuit in which are located the oscillation transformer and the indicator. In this de Forest circuit, as the devices are arranged . . . two circuits are used, and the cold element is correspondingly divided up. These are two well-known, standard, equivalent circuits. You may use either device in either circuit."

Of all the explanations of the action of the de Forest, that of Armstrong in the *Electrical World* (December 12th, 1914, Plaintiff's Exhibit 45), seems most convincing, and that article, for purposes of brevity, may be regarded as being read into this opinion. (See also Dr. Austin's *Bulletin of the Bureau of Standards of the Department of Commerce and Labour.*)

In reading this literature, it must be remembered that both sides agree that the de Forest two-element and three-element bulbs operate on the same principle.

As Armstrong was on the stand and subject to cross-examination, his article is to be treated not merely as a scientist's essay but as equivalent to testimony. Its details cannot be satisfactorily abstracted, but the result is that the weight of the evidence points to the conclusion that defendants' device is one of unilateral conductivity or, in other words, a rectifier permitting current to flow in one direction only—viz., from plate to filament and from grid to filament.

The two circuits used are, as Waterman said at the beginning of the case, a division of Fleming's single circuit, the grid-filament division being the branch for impressing the oscillations on the detector and the plate-filament division being the branch for indicating the signal ; and it is established with reasonable certainty that defendants' device, in order to operate, must have a heated electrode connected to the negative terminal of the local battery. (See also Fleming's *Technics* article, Plaintiff's Exhibit 22, and Waterman's experiment at High Bridge, test. 1,566 *et seq.*, and 1,481 *et seq.* See also transcript of oral argument of Mr. Hoguet at pp. 30-34, expressing briefly the views which I accept as to the action of defendants' device and the controverted points as to the galvanometer and telephone.)

In Exhibit 123 plaintiff has compiled some twenty articles to show the identity of the Fleming and de Forest detectors. Of course (except Armstrong's article, because he testified), these articles do not prove

THE THERMIONIC VALVE IN

plaintiff's proposition, but they do show the point of view and the opinion entertained by many scientific authors.

Against all these we find Pickard standing alone, except in so far as the interesting theoretical exposition of Dr. Davis supports him.

Pickard has developed the theory that the local battery changes the mode of operation of the incandescent lamp from rectifier to relay, but, while many experiments were made and much testimony was given, this theory is still in the realm of speculation, and certainly has not been satisfactorily demonstrated. Indeed, it was necessarily stated by Waterman and admitted by Pickard, that the ultimate mechanism of the subject matter is not known, and that physicists are compelled to change their theories from time to time in the light of later investigations.

In order to reconcile the explanation of the action of the de Forest grid detector with the language of de Forest's earlier patents so as to work out the idea that de Forest's two- and three-electrode detectors were simply the logical development of original thought, Pickard advanced the theory that the action of the de Forest grid was by ionisation by impact, and, therefore, that it was necessary to have a local battery to impel electrons at a high speed on their journey of succeeding collisions.

But this theory is shattered or at least impaired by the tests which showed that when ionisation by impact occurred the detector showed a blue glow and stopped operation. If anything was shown in this regard it was rather, as plaintiff contends, that the device operates in spite of and not because of ionisation by impact.

Within the limits of an opinion it is, of course, impossible to analyse at length a mass of experiments, tests, and theses, and an infinity of detail necessarily involved in the testimony of experts in an art of this kind; but, if plaintiff's theory that its own device and that of defendants' operate on the same principle has not been proved (and I think it has as far as such proof is yet possible), at least defendants' theory has not been satisfactorily demonstrated, and, finally, the physical facts all support plaintiff's claims.

Here, as is so often the case in law suits, resort is had to the story of events and the outcroppings of human nature.

De Forest had long been proceeding on a theory different from that of Fleming. Having read Fleming's article, he began to experiment with the incandescent lamp. He probably doubted its efficacy at first, but within a very short space of time—perhaps a week, perhaps a month—he changed his mind and, discovering that Fleming was right, wrote his solicitor, after he had filed his application for No. 824,637, that the “new receiver is the best yet.” Thereafter, he used the language of the incandescent lamp, and in an address on October 20th, 1906, before the American Institute of Electrical Engineers really described fundamentally the Fleming lamp detector although using phraseology which has since become Audion vocabulary. Thus, the physical ocular fact is that in the alleged infringing P.N. device, the Fleming detector and not the Bunsen burner is used, and the broad Claim No. 1 of the Fleming patent is infringed, precisely the same as if a patented crystal had been placed in some old or new type of circuit with a local battery—such, for instance, as the Weagent and Armstrong circuits.

In respect of Claim 37, defendants' device does not escape because the circuit outside the vessel is divided into two branches nor because Fleming's detector of a “continuous current” was a galvanometer, and de Forest's is a telephone long well-known in the art.

De Forest in his three-electrode audion has undoubtedly made a contribution of great value to the art, and, by the confession of judgment

RADIOTELEGRAPHY AND TELEPHONY

in respect thereof, defendant company may enjoy the just results of this contribution; but, on the other hand, Fleming's invention was likewise a contribution of value, and is to be treated liberally and not defeated either by unconfirmed theory or by association in apparatus where later developments have taught how other useful adjuncts can be employed.

Claims 1 and 37 of plaintiff's patent are valid and infringed by defendant company; defendants' counterclaim will be dismissed, and, as there is no evidence against de Forest individually, the bill as to him will be dismissed.

(Signed) JULIUS M. MAYER,

District Judge.

1. Addendum as to costs. The decree may be submitted to me per the clerk's office) prior to my return on October 2nd. Notice of settlement should be three days. Costs will be awarded to plaintiff as follows: (1) Costs on plaintiff's bill and taxable disbursements incurred by plaintiff in defending so much of the counterclaim as was tried out. To defendant company, taxable disbursements, if any, in connection with the two confessed judgment patents. To de Forest individually, costs against plaintiff.

2. Addendum as to laches. Mention of this subject was made by counsel for defendants at the concluding argument and in the brief. No evidence has been adduced indicating an estoppel and mere lapse of time is not enough.

3. Appeal. If an appeal from interlocutory decree is to be taken the injunction will be suspended provided defendant company (a) gives a bond in a reasonable amount; (b) makes monthly reports as to sales, and (c) is expeditious in appealing.

(Signed) JULIUS M. MAYER,

District Judge.

September 20th, 1916.

UNITED STATES CIRCUIT COURT OF APPEALS

FOR THE SECOND CIRCUIT.

MARCONI WIRELESS TELEGRAPH COMPANY OF
AMERICA,
Plaintiff-Appellee,
vs.
DE FOREST RADIO TELEPHONE AND TELEGRAPH
COMPANY,
Defendant-Appellant. } Equity No. 12-31.

Before :

HON. ALFRED C. COXE,
HON. HENRY WADE ROGERS,
HON. CHARLES MERRILL HOUGH,
Circuit Judges.

OPINION.

Appeal from final decree in equity entered in the District Court for the Southern District of New York.

The plaintiff (hereinafter called "Marconi") brought this action against defendant (hereinafter called "De Forest") alleging infringement of Claims 1 and 37 of Patent dated November 7th, 1905, issued on application of John Ambrose Fleming, filed April 19th, 1905 (No. 803,684). The claims in suit are as follows :

"1. The combination of a vacuous vessel, two conductors adjacent to but not touching each other in the vessel, means for heating one of the conductors, and a circuit outside the vessel connecting the two conductors."

"37. At a receiving-station in a system of wireless telegraphy employing electrical oscillations of high frequency a detector comprising a vacuous vessel, two conductors adjacent to but not touching each other in the vessel, means for heating one of the conductors, a circuit outside of the vessel connecting the two conductors, means for detecting a continuous current in the circuit, and means for impressing upon the circuit the received oscillations."

After action begun, plaintiff entered a disclaimer

"to the combinations of elements set forth in Claim 1 . . . except as the same are used in connection with high frequency alternating electric currents or electric oscillations of the order employed in Hertzian wave transmission,"

and also to certain words of the specification referring to low-frequency currents.

Action was brought not only against the present appellant, but Dr. Lee de Forest individually. The bill as to him was dismissed, and no appeal taken thereto.

RADIOTELEGRAPHY AND TELEPHONY

Defendant answered and set up a counterclaim (practically a separate action), alleging that Marconi had infringed and was infringing certain claims (not necessary to specify) of the following patents belonging to defendants—viz., Nos. 867,876, 867,877, 867,878, and 978,275; which four issues resulted from division of a single application filed February 2nd, 1905.

The counterclaim alleged, further, infringements of Patents Nos. 824,637 and 836,070. Of these, 836,070 is a division of an application thought to cover both inventions, and filed January 18th, 1906. Defendant also counterclaimed upon Patent 841,386, application filed August 27th, 1906. Thus the counterclaim was tried on the foregoing seven patents, of which the first four antedate Fleming.

The counterclaim, however, also set up two other Patents, Nos. 841,387 and 879,532, both of date not only later than Fleming, but later than any of the other and above enumerated patents. As to these plaintiff permitted defendant to take a decree at or shortly before trial.

The lower court (Mayer, *J.*) held that de Forest had infringed both claims in suit of the Fleming patent, and that Marconi had not infringed any of the claims of the patents set up in the counterclaim and not confessed. All of defendant's patents had been issued on applications of Dr. Lee de Forest, and will hereinafter be referred to collectively as the de Forest patents.

From a decree granting injunction on the Fleming patent, and dismissing the counterclaim, de Forest took this appeal.

FREDERICK P. FISH (MESSRS. PHILLIP FARNSWORTH, HARRISON S. LYMAN, and GEORGE F. SCULL with him on the brief),

For Appellant,

J. EDGAR BULL (MESSRS L. F. H. BETTS and RAMSAY HOGUET with him on the brief),

For Appellee.

HOUGH, *J.* :

The subject matter of this action is a "detector." That word will be used in this decision as signifying any device or piece of apparatus which, when energised, actuated, or acted upon by or by means of the co-called Hertzian waves, enables man through the senses of hearing or sight, to understand signals based upon the intentionally regulated emission or propagation of the waves aforesaid.

The patent of the bill is said to cover and protect a detector, hereinafter called the "Fleming valve." Defendant uses a detector which he calls the "audion." Plaintiff asserts that while the audion may be for some practical purposes an improvement on the Fleming valve, it is nevertheless an infringement, and it has given evidence of faith in its own theory, by admitting infringement of the two patents (hereinabove specified) which essentially describe one form of audion—known herein as the "three-electrode" apparatus.

Defendant, not content with this admission, insists: (a) that the Fleming valve was not patentable considering the state of the art at date of application; (b) that the valve and the audion utilise and depend for efficacy upon wholly different operations of nature, and (under its counterclaim) (c) that the de Forest patents still in suit cover devices in principle identical from the earliest to the latest, which patents Marconi has infringed by using a device named by defendant the "two-electrode" audion.

It is said that Dr. de Forest disclosed by his earlier patents, and before Fleming filed his application, a theory which, reduced to practice, resulted in the perfected audion of the confessed patents, wherefore

THE THERMIONIC VALVE IN

the device of every one of the de Forest patents is (by defendant's witnesses) called an audion, although that word was not coined until shortly before applications for the confessed patents were filed. To paraphrase an argument, it is said that Marconi cannot logically confess judgment under two patents and yet deny infringement of the earlier de Forest inventions, because they all constitute a connected, logical, coherent development of a single inventive thought or application of a scientific theory.

These contentions have opened the door (without objection, or very little) to a mass of opinion evidence which, in our judgment, is of no legal value. Much of this record arises out of the mystery still notoriously enveloping the wave movements of the imponderable ether—that is, out of the nature of phenomena by which none of our five senses is directly affected. It consists of opinions or theories concerning such phenomena, opinions necessarily subject to revision, perhaps in a few months. The principal producer of such evidence (if it can be so called), Mr. Pickard for the defendants, admitted repeatedly that the views he advanced on the witness stand he had not entertained a little time earlier; though he had apparently given his abandoned theories more publicity than normally attaches to testimony in a patent cause. He would probably be the last to deny that his present opinions are final, even for himself. To call such theorising evidence is a misuse of the word; for the patent law can deal little in such matters; neither a process of nature nor the discovery thereof is patentable; man-made statutes permit to be protected and monopolised only some perceptible means or certain method of harnessing or utilising forces, however mysterious, uncertain, or perhaps incomprehensible. The only question in this case is whether some known operations of nature were, by proved, tangible, and visible implements, harnessed and made useful; if so, he who first did it may be protected in what he did in accordance with statute laws.

Why a given device works, or the theory of its functioning is a fascinating inquiry; but unless that "why" can be proved within the very modest limits of legal evidence, opinion evidence becomes the rampant speculation of this transcript. It is usually impossible for trial courts to limit opinion evidence (for fear of losing something of value), but efforts in that direction are much needed in the interest of celerity and clarity. Counsel introducing experts who use the witness chair as a rostrum confer no benefit on their clients.

The Fleming valve as a detector confessedly, and the actual commercial "audion" (as we are convinced), consist essentially in the utilisation by visible and tangible means of what has long been known as the "Edison effect," which means the fact that when there is introduced into the ordinary incandescent electric lamp bulb an electrode other than the incandescent filament (such unheated electrode being connected with the positive terminal of the lamp) a current flows from the incandescent electrode to the cold one, in such wise that variation in the electro-motive force producing incandescence will be reflected or reproduced in the circuit connected with the cold electrode, such variations being capable of measurement by a galvanometer. (Edison, Patent No. 307,031.)

Utilisation of the Edison effect does not mean that the use of Edison's apparatus or any modification thereof as a detector was easy or simple. The admitted fact that years passed, and detectors of various kinds from the coherer to the crystal acquired vogue, before anyone thought of using Edison's curiosity of electricity for the discovery or translation of Hertzian waves is proof enough on this point. Fleming was the first to disclose an apparatus for this purpose. His specification declares

RADIOTELEGRAPHY AND TELEPHONY

that he "rectifies" the alternating current transmitted from the antenna. Defendant's witnesses declare that rectification means *converting* "the received alternating currents into direct currents," and they spend much time in attacking Fleming's theory of the operation of his own device. But the law is not concerned with why the process called rectification takes place, or how it is accomplished, further than to observe that variations in group frequencies of an alternating current passing through an incandescent lamp filament produce in a manner analogous to the observed Edison effect a direct pulsating or intermittent current in the cold electrode circuit, and that these pulsations or intermittances mark the kind of current whose varying energies can be read with a galvanometer or a telephone. Whether Mr. Fleming's theories of rectification were right or not has nothing to do with the question of invention or validity. The patentee may not understand his own mechanism, but if he shows and describes it and it produces a new result, the law is satisfied. (*Van Epps v. United, etc., Co.*, 143 F.R., at 872.) Therefore, the first question (as stated by appellee) is substantially this: Was it invention to use, "as a detector of wireless waves, an Edison hot and cold electrode lamp?" This is a question of fact, and we arrive at the conclusion of the lower court, that at the date of Fleming's application it was not known to men skilled in the radio art that a rectifier would act as a detector or that anything that would rectify oscillations of low frequency could rectify waves of the order used in radio communication. Edison's patent stated a fact and suggested a tantalising mystery, because even he did not pretend to state, or assert that he knew, why his "effect" took place. His disclosure remained (so far as we can discover from this record) a laboratory problem until Fleming applied it (whether with a wrong theory or a right one is immaterial) to a new and very practical field of usefulness.

While "invention" is a word the definition of which the courts do not attempt (*MacClain v. Ortmayer*, 141 U.S., at 427), many of the elements contributing to its signification may be and have been described: there must be more than a theory or mental concept—viz., a tangible reduction to practice (*Corrington v. Westinghouse, etc., Co.*, 178 F.R., at 715), and the transformation of a laboratory experiment into a successful and useful mechanical device is evidence of such tangible reduction to practice and of invention (*Westinghouse, etc., Co. v. New England, etc., Co.*, 110 F.R., 753).

In this case, while it is true that Fleming's detector uses the Edison effect every time it detects, the step from a toy to a use suggests what was said in *Hobbs v. Beach*, 180 U.S., at 392—viz., that while there was an analogy there was not similarity between the functions of the patented device and of the alleged anticipating apparatus. The point is not capable of much argument; the appeal is to a kind of conscience, and the court or jury intuitively and conscientiously feel either that invention is absent, or that something akin to genius is displayed in the visible, tangible result of the mental concept. We have no doubt that Fleming's patent displays invention, and of a very meritorious device.

Assuming now the validity of the patent, it is upon the question of infringement that this record has been filled with theories, until it is necessary to call firmly to mind that what is complained of as an infringement is not a theory or a function, but a thing compact of glass and metal, made and sold by defendant as the "three-electrode audion" or "P.N. detector."

Defendant insists that even if Fleming's patent is valid, even if the audion may exhibit at times the Edison effect, yet since knowledge of

THE THERMIONIC VALVE IN

that phenomenon antedated Fleming, they and all the world can avail themselves of Edison's knowledge even in detectors, if their detectors function in a different way or produce substantially different results from those of Fleming (*Machine Co. v. Murphy*, 97 U.S., 120). Accordingly it is asserted that the audion is not merely an incandescent light bulb with two cold electrodes (instead of one) inside it—but an apparatus in which the bulb contains “a substantial amount of gaseous medium” essential to operation of the device; and further that a certain arrangement of circuits, the use of condensers and the introduction of a battery into the cold electrode circuit, are all elements which in combination constitute the audion, produce the “audion effect,” and render the completed whole a different thing from anything Fleming thought of.

The “audion effect” is more specifically this. The battery circuit produces a constant current through the telephone; the input or arriving oscillations, passing through a condenser, and thence from incandescent filament (and grid) to the battery circuit, would not of themselves be normally strong enough to excite the telephone, but they can and do produce changes in the battery current sufficient for that purpose; they, so to speak, pull a trigger, and this trigger action is the audion effect; wherefore the audion is not a rectifier, but an “amplifier.”

It seems clear to us that some of the foregoing is disingenuous, and more immaterial. The “gaseous medium” of the audion is nothing but the commercial vacuum of the ordinary electric light bulb—air being a gas, and the bulb containing some residual air. In other words, defendant uses the same “vacuous vessel” that Fleming does.

As for the “trigger action,” “audion effect,” and such-like clever phrases, they merely hide the real inquiry—viz., how do the high-frequency oscillations, or any part of them, or their electrical result or influence, get into the indicator or battery circuit, no matter what they do after arrival?

Plainly, it is done just as in the Fleming valve; this is the one act, or step, which is essential to either a valve or an audion being a detector, and Fleming's invention consisted in producing a detector, which Edison did not do; a detector must act on alternating currents. This it is that makes defendant an infringer by the manufacture and sale of what may be, and probably is, an improved detector.

The contention that Fleming's patent, whatever its original merit or lack thereof, was voided by an unlawful disclaimer, is without substance. The mistake (if there was one) was in claiming something not needed, and the disclaimer abandoned what was not wanted, without broadening or enlarging any claim; it also left the claims fully supported by the original specification. No injury to defendant or anyone else is shown. The procedure is within *Carnegie Steel Co. v. Cambria Iron Co.*, 185 U.S., 403, and our former decisions in *Simplex, etc., Co., v. Pressed Steel Co.*, 189 F.R., 70, and *Strause, etc., Co. v. Crane Co.*, 235 F.R., at 129.

The position of defendant in respect of the counterclaim patents has been given, but as put by counsel, it is as follows:

“De Forest was the first inventor of a detector comprising a local circuit, containing a battery and a telephone, this circuit having terminal electrodes in a gaseous medium such as air, made conductive by electrode heating by electric means.”

This is not the whole thesis, but it is enough for present purposes.

The position thus defined amounts to asserting that if defendant can show that the inventor had one thought running through his mind, and produced a series of patents for what from time to time appeared

RADIOTELEGRAPHY AND TELEPHONY

to him the best current embodiments of that thought, that, therefore, anyone who constructs another apparatus utilising the same theory of action must be an infringer of the whole line of patents.

While not accepting such view of the law, we shall first ascertain what visible objects plaintiff has made, sold, or used which are said to infringe the counterclaim patents. The detectors called by defendant "Marconi's earlier infringement" or the "two-electrode audion" are especially complained of, though since it is agreed that the "two-" and "three-electrode audions" operate on the same basic principle, no reason appears why defendant must not contend that the same things which admittedly infringe the confessed patents also infringe all the counterclaim patents.

But even on defendant's summary of these de Forest patents, there can be no infringements if as matter of fact the patentee (1) was not the first to disclose a detector with the enumerated characteristics, or (2) never disclosed or patented as an element of his device "terminal electrodes in a gaseous medium such as air," or (3) if the devices of the counterclaim patents still in suit are for any reason different in kind from those covered by the confessed patents, or (4) if the patents in suit on the counterclaim are inoperative or invalid.

(1) De Forest was certainly not the first to disclose or invent a detector comprising a local circuit containing a battery and a telephone, and we find it true that the so-called "two-electrode audion" is no more than a Fleming valve with and in a circuit with adjuncts antedating both De Forest and Fleming.

(2) The expression "gaseous medium such as air" is an endeavour to conceal what we regard as the plain disclosure of all the counterclaim patents based on original applications dated February 2nd, 1905, and January 18th, 1906—viz., that the patentee's fundamental concept was to produce conductivity by heating. He thought and taught that heated air, or the heated gases of, e.g., halogen salts, when the point of dissociation into positive and negative ions was reached, produced a medium favourable to conductivity.

Neither of plaintiff's devices operates on any such principle; whether there is any merit in de Forest's disclosure is immaterial.

(3) We agree with the court below that the radical difference between the disclosures of the first six counterclaim patents and anything shown to have been used by Marconi is apparent on inspection; because none of de Forest's devices utilise a commercial vacuum, or what defendant's expert called a vacuum of the order of an ordinary electric light.

(4) The seventh counterclaim patent (841,386) is proved to be inoperative. The patentee declares that by "suitably varying the length of interelectrode medium" he can make the audion "*per se* selectively responsive." Assuming this last phrase to mean "make it work" defendant at the trial did not do it, and we think refused to try.

It follows from the foregoing that we hold Patent No. 841,386 void and all the other patents of the counterclaim (still in suit) not infringed.

It is not often that any case contains so much history as does this one. It is true that Dr. de Forest, through the whole line of the counterclaim patents, sought after a commercially useful detector, and ultimately produced one; but it is not true that he consistently followed one concept or theory and tried to reduce that to practice. He began with the heated gas theory; he ended with the three-electrode audion, employing the commercial vacuum, and before he produced that success he learned of Fleming's invention and the latter's

THE THERMIONIC VALVE

address before the Royal Society. He promptly used the knowledge so acquired, and it is the endeavour to connect these differing lines of effort and conceal their lack of normal connection that has produced the theorising of this record, and also the persistent use of the word "audion" as applied even to the earliest de Forest patents, which are of dates before that word was coined.

Among the curiosities of evidence in this record are numerous extracts from technical periodicals giving the opinions of the authors on the subject matter of this suit. One from *The Electrician* of November 21st, 1913, is a just comment on the cause :

"We think that Dr. de Forest might be more generous in his acknowledgment of the work of Dr. J. A. Fleming. Our readers generally will probably agree that the audion, although differing widely from the Fleming valve, is an offshoot of it."

The decree below is affirmed with costs.

CHANCERY DIVISION, ROYAL COURTS OF JUSTICE, GREAT BRITAIN.

EXTRACT FROM THE JUDGMENT OF MR. JUSTICE SARGANT, DECEMBER 16TH, 1918, IN THE MATTER OF FLEMING'S PATENT, NO. 24,850 OF 1904.

(Petition for Prolongation.)

"I think that the invention was one of very considerable utility, both in itself and its consequences. It was a pioneer invention in this sense, that it disclosed a cheap, simple and handy device applicable for detecting wireless waves at any receiving station, and, of course, reading their message in such code as the Morse Code.

"That it was capable of having improvements made on it is no real objection, and indeed is rather an advantage from this point of view. I regard the subsequent introduction of a potentiometer into the detecting circuit as being in the nature of a mere improvement on the original Fleming Valve, though no doubt an important improvement, and though I should hesitate to describe the three-electrode valve or de Forest valve as being a mere improvement in view of the great independent invention displayed in that device, I do not think that that valve would ever have come into being but for the previous invention of the 1904 Fleming valve ; though it is, of course, obvious and is admitted by the Petitioners, that where the de Forest valve acts as an amplifier it is outside any claim on the Fleming patent of 1904. It seems to me that the Fleming invention of 1904 is a pioneer invention in the sense of being a representative of an entirely new class of instrument in connection with the detection of wireless waves. And notwithstanding that there were already certain classes of detectors already in use . . . it was to my mind of distinct public utility that a fresh alternative class of instrument should be invented, based on entirely different principles and of a very portable and handy design. In my judgment, therefore, the invention was one of unusual utility."

INDEX.

- Amplification Factor of a Three-Electrode Valve, Method of measuring the, 248, 249
- Amplification Factor, Variation of, with Plate Voltage, 250
- Amplifying Power, Form of the Characteristic Curve necessary to give good, 135
- Appleton, E. V., 142
- Appleton, E. V., Discussion of the Production of oscillations by a Three-Electrode Valve by, 175
- Appleton, E. V., A Method of Measuring the Slope of the Characteristic Curve of a Three-Electrode Valve due to, 142
- Arco, G. Von, 149, 151
- Armstrong, E. H., 121, 122, 123, 125
- Armstrong, E. H., Inductive Coupling of Grid and Plate Circuits of Thermionic Amplifier by, 153
- Armstrong, E. H., Investigations on the Theory of the Three-Electrode Valve, by, 121, 123, 124
- Armstrong, E. H., Method of re-active Coupling of Grid and Plate Circuit due to, 137
- Armstrong, E. H., Method of using Three-electrode Valves to eliminate Atmospheric Effects in Case of Undamped Wave Reception due to, 208
- Armstrong, E. H., Mode of Coupling Three-Electrode Amplifiers in Cascade, with Grid and Plate Circuits reinforced, by, 190
- Armstrong's Coupling for Beat Reception in Case of Three-Electrode Amplifier, 196, 197
- Arrangement of Two Valves in Cascade Coupled through an Iron-Cored Choking Coil, due to A. Hoyt Taylor, 233
- Audio-Amplification, Definition of, 138
- Audio-Amplification, Coupling for 139
- Audion, The, 108, 110, 127
- Austin, L. W., 202, 203
- Balanced Valve Receiver Set, 204
- Ballantine, S., 245, 251
- Beat Reception in Wireless Telegraphy, 194
- Beat Reception Employing Thermionic Apparatus, Methods of, 240, 241
- Beats, Combination of Two Oscillations of Different Frequencies producing, 192, 193
- Belty, H. H., 247
- Bijl, H. J. Van der, 146, 245
- Branly E., 3
- Cascade Connection of Amplifiers, 141
- Cascade Coupling of Three-Electrode Amplifiers for Radio and Audio-Amplification, 191
- Cathode Ray Particle, 23
- Cathode Ray Particle, Deflection of, by Electric or Magnetic Fields, The, 24
- Cathode Ray Tube, A., 24
- Characteristic Curve for Thermionic Emission, 41
- Characteristic Curve of Three-Electrode Valve, The, 121, 126
- Characteristic Curve of Three-Electrode Valve, Mode of Determining the, 122
- Characteristic Curve, Measurement of Slope of, due to E. V. Appleton, 142
- Characteristic Curve of the Dynatron, 167
- Characteristic Curves, The Two Principal, 223, 246

INDEX.

- Characteristic Surface of a Three-Electrode Valve, Equation given by G. Vallauri for the, 246
- Charcoal Vacua, 97
- Coherer, Branly, 3
- Coherer, Lodge, 3
- Coherer, Marconi, 3
- Coherer, Walter, 3
- Coherers, Various Types of, 3
- Conditions for the Auto-Production of Oscillations by a Three-Electrode Thermion, 251, 252, 253
- Conditions for the Establishment of Self-sustained Oscillations in the Three-Electrode Thermion, Discussion of, by L. A. Hazeltine, 168, 171, 172, 173, 174
- Continuous Oscillations produced by a Three-Electrode Valve, 251, 252, 253
- Continuous Wave Generation by the Three-Electrode Valve, 239
- Continuous Wave Reception effected by the Three-Electrode Valve, 235
- Continuous Wave Reception by a Three-Electrode Valve, Scheme of Connections for, 240, 242
- Cosmos High Vacuum Mercury Pump, 101
- Court of Appeals, U.S.A., Judgment of the, on the Valve Patents, 47, 48 (see also *Appendix*)
- Crookes, Sir William, 23
- Crystal Detectors, 4
- Cycloid, The Equation of a, 31
- de Forest, Lee, 47, 201
- de Forest, Lee, Improvements in the Thermionic Detector, by, 102
- de Forest, Lee, U.S.A. Patent Specifications for Thermionic Detectors of, 104, 105, 106, 107
- Detector, The Crystal, 4
- Detector, The Electrolytic, 4
- Detector, Various types employed in Wireless Telegraphy, 3
- Detectors, Methods for comparing Sensitivity of, 87, 88
- Dewar, Sir James, Method for making High Vacua, due to, 97, 98, 99
- Dushman, S., 78
- Dyke, G. B., 92
- Dynatron, The, 158, 159
- Dynatron, as Generator of Oscillations, The, 163
- Dynatron, as Voltage and Current Amplifier, The, 162, 163
- Dynatron, The, as a Generator of Oscillations for Radiotelephony, The, 217, 218
- Dynatron, The Characteristic Curve of the, 160
- Eccles, E. H., 139
- Edison, T. A., 5, 7, 8
- Edison Effect, The, in Glow Lamps, 7, 8, 9, 10, 16
- Electric Arc, The Edison Effect in the, 14
- Electric Beats, Mode of production of, 192
- Electric leakage of positive and negative electricity from incandescent iron, 19
- Electron, The, 23
- Electron, The charge of an, 22, 33
- Electron, The mass and size of an, 34
- Electrons liberated by ultraviolet light from metals, 30
- Elster and Geitel, Investigations of, on leakage of electricity from incandescent wires in vacuo, 20
- Fleming, J. A., 6, 9, 13, 46, 47, 51, 52, 53, 54, 61, 78, 87, 92, 102, 116, 119
- Fleming, J. A., Investigations of, on the Edison effect by, 9, 10, 11, 12, 13, 15
- Fleming—de Forest, Controversy on Invention of the Thermionic Valve, 102
- Fleming Valve, The, 4, 46, 47, 176, 177, 178
- Fleming Valve, The History and Invention of the, 50, 51, 52, 53
- Fleming Valve, Characteristic Curves of the, 57, 69, 71
- Fleming Valve, Mode of use of, as a rectifier of oscillations, 54, 55
- Fleming Valve Patents (see also *Appendix*), 52, 113
- Fleming Valve, Rectifying power of a, 56, 58, 59
- Fleming Valve, Various types of, 66, 67
- Fleming Valve, Use in Wireless Telegraphy as a Detector, 61, 64, 72

INDEX.

- Filament-heating Battery, Usual type of, 224
- Fitzgerald, G. F., 2
- Flywheel Circuits, 169
- Franklin, C. S., 148, 153, 185
- Franklin, C. S., Connection of Three-Electrode Amplifier with grid and plate circuit coupled and crystal as a detector, due to, 185
- Gaede Pump, The, 93
- Grid, Effect of the structure of, on the operation of a Three-Electrode Valve, 223
- Guthrie, F., 19
- Hard and Soft Valves, Definition of, 75
- Hazeltine, L. A., 166, 251
- Hertz, Ring resonator of, 2
- Heterodyne Method of reception of undamped Electric Waves, 198, 201
- High Vacua, Methods for making, 97, 98, 99, 100, 101
- Hill, S. E., 67
- Hittorf, W., 13
- Hogan, J. J., 198
- Hoyt-Taylor, A., 233
- Hull, A. W., 158, 165
- Hydrogen Ion, The Electric Charge of a, 22
- Internal Resistance of a Three-Electrode Valve, The usual, 225
- Internal Resistance of a Three-Electrode Valve, Method of measuring the, 250
- Ions liberated by heat from incandescent carbon, 32
- Ions liberated by ultra-violet light from metals, 30
- Judgments in the United States Courts of First Instance, and of Appeals on the Fleming Valve Patents (see *Appendix*)
- Kenotron, The, 80, 81, 82
- Langmuir, Irving, 43, 74, 75, 76, 77, 95, 100, 219, 220, 245
- Langmuir, Irving, Equation for the Characteristic Surface of a Three Electrode Valve, given by, 245
- Langmuir, Irving, Investigations on Thermionic Emission, by, 76, 77, 78, 79
- Langmuir, Irving, High Vacuum Pump of, 99, 100
- Langmuir, Irving, Mode of Use of the Pliotron in Radiotelephony, described by, 219, 220
- Langmuir, Irving, Vacuum Gauge, The, 95
- Lieben, Reisz, Thermionic Relay, 133, 134
- McLeod Vacuum Gauge, The, 95
- Magnetic Detector, The Marconi, 3
- Marconi, Senatore G., 2, 3, 61, 63
- Marconi Company's Apparatus for Radiotelephony, 216
- Marconi Company's Valve Receiver Set, Type 50, 226
- Marconi Company's Valve Receiver Set, Type 55, 227, 228
- Marconi Company's Valve, V 24, 230
- Marconi Company's Q-Valve, 222
- Marconi Company's Valve Receiver Set of Variable Wavelength, 232
- Mass of an Electron, 30
- Maxwell, James Clerk, Electromagnetic Theory of, 2
- Meissner, A., 148
- Meissner's Circuits for employment of the Thermionic Valve as a generator of oscillations, 149
- Miller, J. W., 245
- Miller, J. M., Methods of measuring the Parameters of a Three-Electrode Valve given by, 247, 248, 249
- Millikan, R. A., Determination of the Electron Charge by, 29
- Molecular Shadows in Incandescent Lamps, 6
- Owen, G., Thermionic Emission from Wehnelt Cathode, 43
- Pickard, G. W., 4
- Pierce, G. W., 4
- Plate Voltage required in a Hard Valve, The, 224
- Pliotron, The, 129, 130, 131
- Pliotron, Characteristic Curve of the, 132
- Pliodynatron, The, 165, 166

INDEX.

- Pliodynatron, The, used as an Oscillation Generator in Radiotelephony, 219
- Preece, Sir W. H., Investigations of, on the Edison Effect, 8
- Proper Coupling of Grid and Plate Circuits for production of sustained oscillations by a Three-Electrode Valve, 251, 252, 253
- Q-Valve, The Marconi Company's, 222
- Radio-Amplification, Definition of, 138
- Radio and Audio-Amplification, Scheme of Connections for combined, 140
- Radiotelephony, 210
- Radiotelephony, Nature of the Transmitter required for, 212
- Radiotelephonic Transmitter employing a Thermionic Valve, 214
- Ratio of Charge to Mass of a Cathode Particle = e/m , 25
- Ratio of e/m for Negative Ions liberated from Incandescent Carbon, 32
- Ratio of Maximum to R.M.S. Value of Damped Oscillations, Formula for the, 244
- Recent Improvements in Thermionic Apparatus, 222
- Regenerative Coupling of the Plate and Grid Circuits, The, 136
- Richardson, O. W., 32, 33, 40, 44, 45
- Richardson's Law connecting Saturation Current and Absolute Temperature in Thermionic Emission, 41
- Round, H. J., 148, 154, 155
- Round, H. J., Apparatus for Radiotelephony invented by, 213
- Round, H. J., Arrangement of Circuits for use of Thermionic Valve as a Generator of Oscillations by, 155
- Round, H. J., Connections for use of Three-Electrode Thermion for Beat Reception, 194, 195
- Round, H. J., Scheme of Thermionic Circuits for Radiotelephonic Transmitter due to, 214, 215
- Round-Marconi Apparatus for Radiotelephony, 216, 217
- Rutherford, Sir E., 3, 29
- Saturation Current, The, 40
- Scott-Taggart, J., 233, 234, 238, 239, 241
- Slope of Characteristic Curve of Three-Electrode Valve, Method of Measurement of the, 143
- Speech, Nature of, 210
- Stokes, Sir G., 26
- Stoney, G. Johnstone, 23
- Telephone Diaphragm, Natural period of Vibration of a, 211
- Theory of the Thermionic Amplifier, given by Van der Bijl, 146
- Thermionic Apparatus, Recent Improvements in, 222
- Thermionic Characteristic Curves, given by Irving Langmuir, 76
- Thermionic Detector in Radiotelegraphy, The, 176
- Thermionic Detectors, 3, 4
- Thermionic Detectors, Measurement of Sensitivity of, 87
- Thermionic emission, 38
- Thermionic emission from various bodies, Coefficients of, 41
- Thermionic emission from incandescent bodies, 36
- Thermionic reception set with very loosely coupled aerial for C.W. waves, 243
- Thermionic Tube, A, 38
- Thermionic Valve, The, 1
- Thermionic Valve as a Generator of Oscillations, The, 148
- Thermionic Valve as a Generator of Oscillations, Scheme of Circuit for use of the, 152
- Thermionic Valve, Importance of Wireless Telegraphy, 1
- Thermionic Valve, Nature of, required for a radiotelephone transmitter, 213
- Thermionic Valve, The, used as a repeater in ordinary telephony with wires, 221
- Thermionic Valve in Radiotelephony, The, 210, 212
- Thermionic Valve used as a Current-limiting Device, 206
- Three-Electrode Valve, The, 102
- Three-Electrode Valve, Connections for use as an Amplifier of the, 183

INDEX.

- Three-Electrode Valve, Connections for use as a Radiotelegraphic Detector of the, 180
- Three-Electrode Valve, Importance of, in C.W. reception, 235
- Three-Electrode Valve, Mode of use as Detector in Wireless Telegraphy, 122, 123, 124
- Three-Electrode Valve used as a Generator of Oscillations, Schemes for using a, 239
- Three-Electrode Valve, various types of, 127, 128, 129, 130, 131, 133, 222
- Thomson, Sir J. J., Discovery of the Electric Corpuscle by, 21
- Thomson, Sir J. J., Researches of, on the Electronic Charge, 26
- Thomson, Sir J. J., Determination of path of an Ion, 31
- Tungar Rectifier, The, 84, 85
- Ultraudion Circuit, The, 201, 202
- Vacuum Gauge, McLeod, 95
- Vacuum Gauge, Langmuir, 95
- Vacuum Gauge, Shrader, 97
- Vacuum Gauge, Knudsen, 97
- Vacuum, The, required in a hard valve, 223
- Vallauri, G., 245
- Vallauri, G., Equation for the Characteristic Surface of a Three-Electrode Valve given by, 246
- Valve, A hard, 75
- Valve, A soft, 75
- Valves Coupled in Cascade through high resistances, 234
- Valve Patents, Litigation on the, in U.S.A., 113, 114, 117, 118, 119, see also *Appendix* for Judgments
- Vowel-sounds, Physical Nature of, 211
- Wehnelt, A., Oxide-coated Cathode of, 42
- Wehnelt, Vacuum Valve of, 82, 83
- White, W. C., 131, 132
- White, W. C., Scheme of Circuits for use of Thermionic Amplifier as a Generator of High or Low-frequency Oscillations by, 156, 157
- Wilson, E., 3
- Wilson, C. T. R., 26
- Wilson, H. A., 42
- Willows, R. S., 67
- Wright, G. M., 205, 206, 207
- Wright, G. M., Method for using the Three-Electrode Thermionic Valve to reduce effect of Atmospheres due to, 206, 207

W. H. SMITH & SON
THE ARDEN PRESS
STAMFORD STREET
L O N D O N , S. E. 1

THIS BOOK IS DUE ON THE LAST DATE
STAMPED BELOW

AN INITIAL FINE OF 25 CENTS

WILL BE ASSESSED FOR FAILURE TO RETURN
THIS BOOK ON THE DATE DUE. THE PENALTY
WILL INCREASE TO 50 CENTS ON THE FOURTH
DAY AND TO \$1.00 ON THE SEVENTH DAY
OVERDUE.

MAR 11 1941

JUL 25 1930
REC. CIR. MAR 25 1930

12/14/06

YC 19356

416180

T.K. 5865

F6

UNIVERSITY OF CALIFORNIA LIBRARY

