

UC-NRLF

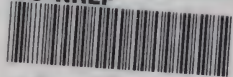

\$B 46 270

VACUUM TUBES
IN
WIRELESS COMMUNICATION

BY ELMER E. BUCHER.



EX LIBRIS

Mech. dept.

Engineering
Library

12

239

VACUUM TUBES
IN
WIRELESS COMMUNICATION

OTHER BOOKS BY THE SAME AUTHOR

PRACTICAL WIRELESS TELEGRAPHY

The standard wireless textbook in use by Army and Navy men and wireless students and operators.

Cloth, 352 pp. Size 6x9". Price \$1.50 net.
Over thirty thousand copies sold.

HOW TO PASS U. S. GOVERN- MENT WIRELESS LICENSE EXAMINATIONS

This handbook containing 142 questions and answers is used as a review quiz by students in connection with PRACTICAL WIRELESS TELEGRAPHY.

Paper, 96 pp. Size 6x9". Price 50c. net.
Over twenty-five thousand copies sold.

HOW TO CONDUCT A RADIO CLUB

Completely revised and enlarged. A complete guide for the formation of a radio club or class, and an excellent manual for experimenter's shop work. It contains a wealth of information that is indispensable to the radio student in commercial, navy, or army work.

Paper, 148 pp. Size 6x9". Price 50c. net.
Over twelve thousand copies sold.

*For more detailed descriptions of these books see
announcements at end of this volume.*

VACUUM TUBES

IN

WIRELESS COMMUNICATION

A PRACTICAL TEXTBOOK FOR
OPERATORS AND EXPERIMENTERS

BY

ELMER E. BUCHER

Instructing Engineer, Marconi Wireless Telegraph Company of America
Member Institute of Radio Engineers. Director of Instruction, Marconi Institute
Author of "Practical Wireless Telegraphy"

This volume shows over 100 different circuits for the practical use of Vacuum Tubes as Detectors, Radio or Audio Frequency Amplifiers, Regenerative Receivers, Beat Receivers, and Generators of Radio Frequency Currents.

A series of graphic charts in the appendix reveals the functioning of the vacuum tube in an elementary manner. The technical introduction reviews the problems of continuous and discontinuous wave transmitters and receivers.

FULLY ILLUSTRATED

UNIV. OF
CALIFORNIA

25 Elm Street



New York

TK5865
B8

Engineering
Library

COPYRIGHT, 1918
BY
WIRELESS PRESS, INC.

mechanics budget

TO WHOM
IT MAY CONCERN

AUTHOR'S NOTE

In preparing the text of this book, the author had two principal objects in view: (1) to provide the Government and commercial wireless operator with a brief and simple explanation of the functioning of the circuits of the vacuum tube, (2) to lay before the experimenter and the practical operator the numerous circuits employed from time to time in the laboratory and in commercial practice.

Outside of its obvious commercial value, the perfected vacuum tube affords the experimenter a most fascinating field of research. This is well evidenced by the fact that a single bulb with associated tuning apparatus connected to a four wire aerial 200 feet in length permits wireless signals to be received over distances of 2,500 to 4,000 miles in daylight, and up to 6,000 miles in darkness. Any experimenter may prove this statement by adopting one of the circuits disclosed in this volume.

TO THE STUDENT AND EXPERIMENTER

Many of the circuits shown in this book are not employed in either Government or commercial wireless communication. Some will be found to be duplicates in so far as their mode of operation is concerned, the various parts of the receiving apparatus being re-arranged or re-grouped. The diagrams represent, however, the connections disclosed from time to time and in order that the student may review step by step the progress in the application of the vacuum tubes, it was thought best to place before him the use of the tube in all its phases.

The connections most suitable for different conditions of wireless service suggest themselves, once the fundamental operating principle of the vacuum tube is understood.

It will very probably develop that some of the explanations of working given herein both for the fundamental arrangements and for systems which are extensions of the simple or fundamental circuits shown in the first three chapters, will not stand the test of further research, but in general it may be said that the use of the vacuum valve as a detector, amplifier, and generator of radio frequency currents is well understood.

The systems described in Chapters III to VII inclusive, are extensions of the fundamental circuits shown in Chapters I, II, and III. Hence, to understand fully the mode of operation of the more complicated apparatus, the experimenter should read the preliminary chapters. Any seeming omissions in the advanced chapters will probably be found covered in the preliminary text.

New York.

E.E.B.

CONTENTS

INTRODUCTION

1. Audio and Radio Frequency Currents.
2. Damped and Undamped Oscillations: (a) The Use of Rectifiers. (b) The Detection of Continuous Oscillations. (c) Distinction Between Continuous and Discontinuous Wave Systems.
3. Receiver Circuits: (a) The Necessity for Tuning. (b) Tuning in Practice.
4. The Telephone Receiver.

PART I

THE OSCILLATION VALVE IN RADIOTELEGRAPHY

5. Foreword.
6. What Is an Electron?
7. How May Electrons Be Set in Motion?
8. Fleming's Discovery.
9. The Oscillation Valve.
10. Demonstration of Rectifying Properties.
11. Non-Uniform Conductivity of the Valve.
12. How the Valve Becomes Saturated.

PART II

PRACTICAL APPLICATIONS OF THE OSCILLATION VALVE

13. In General.
14. Action of the Simple Valve.
15. The Practical Oscillation Valve Circuit in Radio: (a) Fleming Valve Circuits in Simple Form. (b) Other Circuits for the Vacuum Valve.
16. The Three-electrode Valve. (a) Characteristic Curve of Three-Electrode Valve. (b) Valve Terminology.
17. The Three-electrode Valve as an Electron Relay and Rectifier: (a) The Valve as an Electron Relay (without Grid Condenser). (b) Functioning of the Valve as Explained from the Characteristic Curve. (c) Relaying Action. (d) Use of the Three-Electrode Valve with Grid Condenser. (e) Radio and Audio Frequency Component of the Plate Current. (f) Summary of the Phenomena of the Characteristic Curve.
18. The Tuned Plate Circuit.

PART III

CASCADE AMPLIFICATION BY THE VACUUM VALVE

19. In General.
20. Cascade Radio Frequency Amplifier: (a) Curves of the Cascade Amplifier.
21. Cascade Audio Frequency Amplifier.
22. Combined Radio and Audio Frequency Cascade Amplifier.

PART IV

THE REGENERATIVE VACUUM VALVE AMPLIFIER

23. In General.
24. Preliminary Considerations.
25. The Principle of Regeneration.
26. Radio Frequency Regenerative Circuit: (a) Phenomena of Regeneration. (b) Adjustment of Regenerative Amplifier.
27. Tuned Plate Circuits.
28. Audio Frequency Regenerative System.
29. Combined Audio and Radio Frequency Regenerative System.
30. Electrostatic and Direct Magnetic Coupling.
31. The "Reaction" Circuits of Franklin and Marconi.
32. Simple Regenerative Circuit.

PART V

COMBINED REGENERATIVE AND CASCADE AMPLIFICATION SYSTEMS

33. In General. 34. Regenerative Cascade Systems. 35. Audio Frequency Regenerative and Cascade Systems.

PART VI

THE VACUUM TUBE AS A DETECTOR OF CONTINUOUS WAVES. AUDIO FREQUENCY TUNING CIRCUITS. SPECIAL CIRCUITS FOR THE VACUUM TUBE.

36. Reception of Continuous Oscillations. 37. The Theory of the Beat Receiver: (a) Phenomenon of Beats. 38. The Simple Heterodyne: (a) Curves of the Beat Receiver in Radio. 39. Selectivity by the Heterodyne. 40. Heterodyne with the Vacuum Valve as a Detector. 41. The Vacuum Valve as a Generator of Radio Frequency Oscillations. 42. The Regenerative Beat Receiver: (a) How the Valve Is Set Into Self-Oscillation: (b) The Phenomena of the Self-Heterodyne. 43. Audio Frequency Tuning. 44. The Weagant Undamped Wave Receiver. 45. Modified Weagant Beat Receiver. 46. Reception of Continuous Waves by the Valve Without Beats. 47. Cascade Amplification. 48. Cascade Regenerative Systems for Beat Reception. 49. Beat Reception from Damped Wave Transmitters. 50. Special Circuits for the Vacuum Valve: (a) The Use of a Rotary Condenser for the Reception of Continuous Oscillations. 51. "Open Circuit" Oscillators for the Vacuum Valve: (a) Modified Open Circuit Oscillators. 52. Amplification by the Heterodyne System. 53. Kenotron and Plotron Vacuum Tubes: (a) The Connections of the Plotron for the Generation of Radio Frequencies at High Current Values. (b) The Plotron as a Generator of High Voltages at Radio Frequencies.

PART VII

WIRELESS TELEPHONY

54. In General: (a) Fundamental Circuits of the Three-Electrode Tube as a Radiophone Transmitter. (b) Rounds' Wireless Telephone System. 55. Hund's Method of Radio Frequency Modulation. 56. Englund's Wireless Telephone System. 57. Carson's Proposed Wireless Telephone System. 58. Espenschied's Duplex Wireless Telephone System. 59. Englund's Duplex Radio Telephone and Radio Telegraph System.

PART VIII

THE DYNATRON DETECTOR AND OSCILLATOR

60. The Dynatron. 61. The Dynatron as an Oscillator. 62. The Dynatron as a Detector of Electrical Oscillations. 63. The Dynatron as a Compensator for Circuit Losses. 64. The Pliodynatron. 65. The Pliodynatron as a Detector. 66. The Pliodynatron in Radio Telephony.

APPENDIX

Diagrams Illustrating Certain Fundamental Actions of the Vacuum Tube as an Oscillation Detector in Radio Telegraphy.

VACUUM TUBES IN WIRELESS COMMUNICATION

INTRODUCTION

Before entering into an explanation of the functioning of the vacuum tube, a brief review of certain facts bearing on wireless transmitting and receiving systems will be given.

1. AUDIO AND RADIO FREQUENCY CURRENTS.—It is well known that vibrations above 20,000 per second are practically inaudible to the human ear. This fact has an important bearing on the reception of radio telegraphic signals by the usual telephone receiver. For example, if a 20,000 cycle current flows through the telephone windings, the diaphragm will vibrate at the upper limits of audibility. If the frequency of the applied current is progressively decreased, the vibrations of the diaphragm become more and more audible, until some value is reached where the maximum deflection of the diaphragm is secured for a given E.M.F.

Considering the foregoing phenomena, a distinction has been drawn between currents within the range of frequencies employed to radiate electric waves in wireless telegraphy and those of lower frequencies, which it is believed are not capable of setting into motion electric waves (this has not been proven), but which are audible in the telephone receiver. A figure of 10,000 cycles has been arbitrarily adopted as a dividing line. The following definition is therefore of immediate importance:

- (1) Currents of frequency above 10,000 cycles per second are termed currents of radio frequency.
- (2) Currents of frequency below 10,000 cycles per second are termed currents of audio frequency.

Now, to explain more clearly what the foregoing remarks have to do with the problems of radio telegraphy we must remember that the

electric waves for the dispatch of wireless messages from ship to ship and from ship to shore are generated by extremely high frequency currents of the order of from 500,000 to 1,000,000 cycles per second. For long distance communication much lower frequencies of the order of 100,000 cycles down to 20,000 cycles per second are employed. Currents of similar frequency are induced in the receiver circuits. But in all cases the frequency of the current is above audition; hence we see that the telephone receiver cannot be employed as an indicator of the passage of such currents.

Keeping in mind that an audio frequency current of from 200 to 1000 impulses per second gives audible response with a minimum of current*, and because the telephone is almost invariably employed as a current translator in radio, we see that the *problem of detection in wireless reception, simply resolves itself into one of converting radio frequency currents into audio frequency currents such as will give the best response in a telephone.*†

These audio frequency currents are not necessarily simple alternating currents. They may consist of *groups of direct current pulses* or they may be *complex audio frequency currents* of various wave forms; whatever their nature, so long as the telephone diaphragm is impulsed from say 200 to 1,000 times per second, the best response will be secured from a given E.M.F.

Devices which effect this conversion are termed *oscillation detectors*,—of which there are many types. The functioning of certain detectors will be briefly reviewed further on.

2. DAMPED AND UNDAMPED OSCILLATIONS.—There are two general systems of radio transmission: *the discontinuous wave system, and the continuous wave system.* The currents by which these waves are set into motion are known as *damped* and *undamped* oscillations respectively. In the discontinuous system, the radio frequency currents are generated in audio frequency groups of 120 to 1,000 per second. Such currents are obtained by the *charge and discharge of a condenser through a circuit containing an inductance.*

Continuous oscillations are generated by

- (1) the radio frequency alternator;
- (2) the direct current arc generator;
- (3) the vacuum tube oscillator;
- (4) by overlapping trains of damped oscillations.

*This statement applies to a sinusoidal E.M.F.

†This, of course, is not true when a measuring instrument is employed to detect the incoming oscillations instead of a telephone.

Several groups of *discontinuous oscillations* are shown in Figure 1. Continuous oscillations are indicated in figure 2. Certain fundamental distinctions in the two systems of radio transmission, particularly in regard to the receiving apparatus, are to be noted.

Let it be understood that the successive groups of radio frequency oscillations shown in figure 1 are generated by condenser discharges occurring at audio frequency. Currents of similar frequency flow in the transmitter aerial, part of the energy being detached in the form of elec-

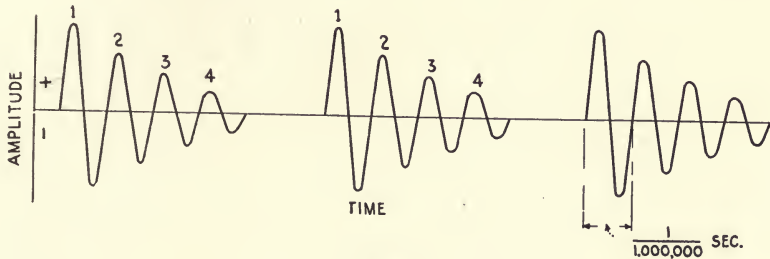

Figure 1

Discontinuous or damped oscillations such as generated by the periodic charge and discharge of a condenser across a spark gap.

tromagnetic waves. These waves generate in the receiver aerial currents of the frequency of the transmitter which in turn are impressed upon a local detector circuit. The frequency of the individual cycles 1, 2, 3, 4, per group are above audibility and cannot be detected directly in a telephone, but by various means these groups may be modified to a form suitable to actuate the telephone diaphragm as will be explained in the paragraph following.

(a) **The Use of Rectifiers.** Audible response in a telephone may be obtained from group frequency (damped wave) transmitters by what is known as a *rectifier* of alternating currents. If such a device is connected in series with the telephone and an oscillating E.M.F. is impressed upon the circuit, one half of the incoming cycle will pass the rectifier but the other half will be practically suppressed. Then, for each group of incoming oscillations (set up in the receiver aerial by the distant transmitter) a group of decaying direct current pulses will flow through the telephone, the average effect of three groups being illustrated by the graphs A, B, C, Figure 3.

Among the crystalline elements possessing the ability to rectify high frequency currents may be mentioned *carborundum*, *galena*, *silicon*, *molybdenite*, *iron pyrites*, *zincite-bornite*.

Rectification also may be obtained by using the one-way conduc-

tivity between a hot lamp filament and a metallic element inserted in a vacuum, i.e., the *vacuum tube*; or we may partially rectify radio frequency currents mechanically as, for example, by driving a *Goldschmidt tone wheel* out of synchronism with the incoming oscillations. In detectors used with a local battery and having suitable operating characteristics, the rectification may be accompanied by a relaying action and

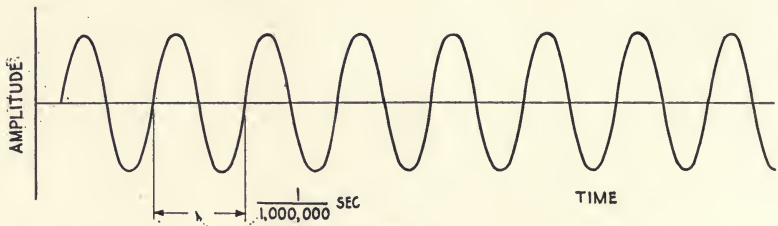

Figure 2

Oscillations of constant amplitude (continuous or undamped oscillations).

amplification of signals may thus be secured. This is particularly true of vacuum valve detectors.

Oscillation detectors suitable for the reception of damped oscillations but now chiefly of historical interest are the *coherer*, and the *microphone detector*, both indicating by virtue of a change in their resistance, the passage of radio frequency currents. The microphone possessed the advantage over the coherer, in that its sensitiveness was automatically restored after the reception of a signal; the coherer required a tapper to place the tube in operating condition after the passage of each signal. This made it particularly sluggish in action.

The Marconi *magnetic detector* takes as its basis of operation the change wrought in the magnetization of a moving band of iron (possibly due to magnetic hysteresis), by the magnetic field generated by the incoming radio frequency oscillations. This change in flux in turn induces an audio frequency current in a small coil of wire, in inductive relation to the iron band, to which is connected a telephone of about 75 ohms resistance.

In this method of reception as with the crystal rectifiers, the telephone diaphragm is impulsed once for each spark at the transmitter.

(b) **The Detection of Continuous Oscillations.** If we connect a rectifier and a telephone in series with a radio frequency circuit in which flow the continuous oscillations shown in Figure 2, it is clear that the telephones will pass a pulsating direct current of continuous amplitude. The individual pulses occur at frequencies above audibility and

no sound will therefore be produced except at the opening and closing of the circuit. It is necessary then, to modify further the resultant current in order to secure audible response, as will be seen further on.

Among the many methods through which *continuous radio frequency oscillations may be converted to audio frequency currents*, we may take as an example the tikker, which is simply a mechanical circuit inter-

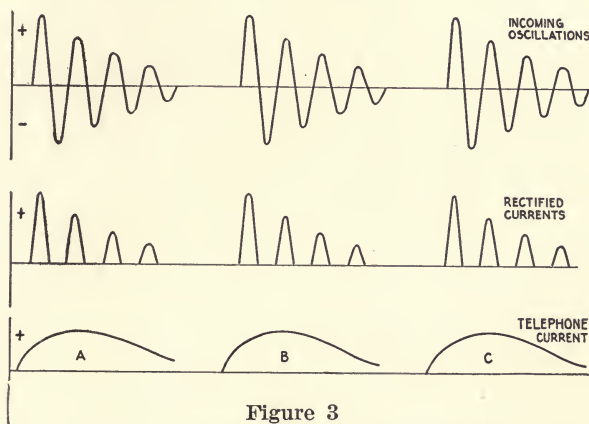

Figure 3

Graphs showing how incoming radio frequency currents are converted to direct current pulses by an oscillation detector.

rupter connected in some part of the receiving system to interrupt the incoming oscillations 200 to 1,000 times per second. The resulting groups (of radio frequency current) in turn energize an audio frequency circuit consisting of a condenser with a telephone in shunt, or, to improve the tone, a crystal rectifier is often inserted in series with the tikker to rectify these groups.

By means of the *slipping contact detector*, continuous oscillations are made audible by virtue of the periodic changes in resistance of some part of the receiver circuit. Incoming radio frequency currents are thus modulated to an audio frequency current which is fairly uniform.

A valuable method for producing an audio frequency current from continuous oscillations is the system which generates what are termed *beat currents*. In brief, if two radio frequency currents of slightly different frequencies be impressed upon the same circuit, they successively *assist* and *oppose*, going in and out of phase progressively. The result is the production of a *third current* called a *beat current*, which, if the frequencies are properly selected, may occur at an audio frequency. Now, one of these radio frequencies may be that of the incoming signal and the other may be generated locally. By proper selection of the two

frequencies, beat currents occurring at an audible frequency suitable for maximum response from the head telephone will be generated in the receiving system. These, if they undergo rectification in some type of oscillation detector, will actuate the telephone diaphragm.

(c) **Distinction Between Continuous and Discontinuous Wave Systems.** The principal points of difference between the damped and un-

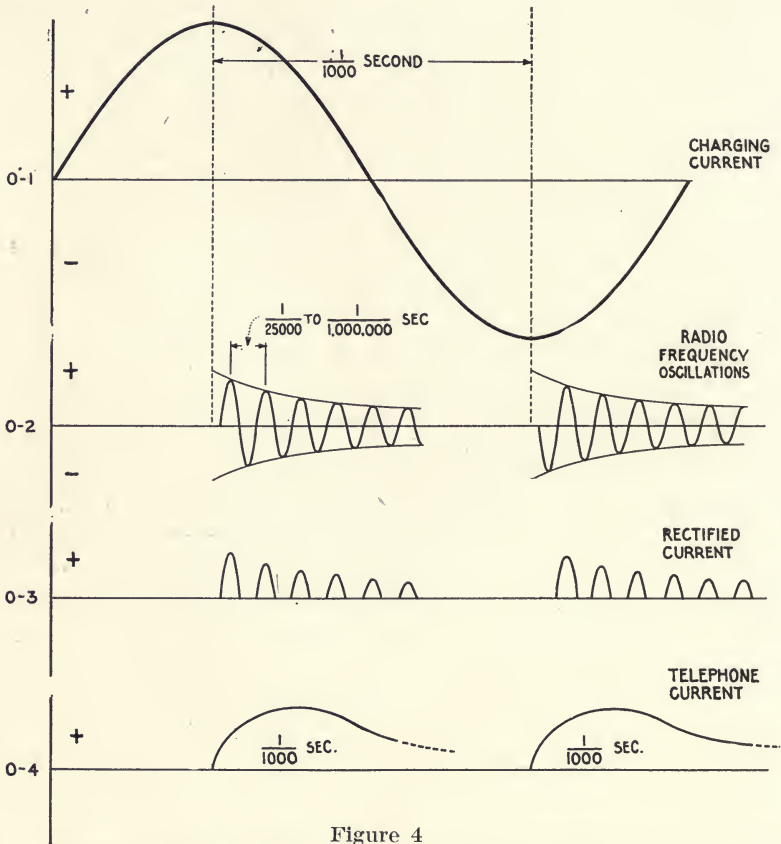

Figure 4

Graphs showing the phenomena involved in the transmission and reception of wireless signals in spark systems of radio telegraphy.

damped wave systems and particularly the problems involved in the detection of currents in either system, at the receiving station, may be explained graphically by the curves of Figures 4 and 5.

In Figure 4, the graphs O-1 to O-4 outline certain phenomena concerning the transmission and detection of electric waves in the *discon-*

tinuous wave system. Graph O-1* indicates *one cycle of charging current* such as is impressed across the transmitter condenser by a high voltage transformer. The frequency of the current is 500 cycles per second. It is assumed that the condenser is charged twice for each cycle. Therefore a 500-cycle generator (and transformer) will energize the condenser circuit 1,000 times per second and 1,000 sparks will discharge across the gap. The discharge, as is well known, gives rise to radio frequency currents.

Each alternation of the charging current, therefore, releases in the closed oscillation circuit one group of radio frequency oscillations which, through a coupling coil are induced in the antenna circuit giving the oscillations shown by graph O-2. Currents of similar frequency are impressed across the oscillation detector (rectifier) at the receiving station, but their frequency is too high for direct response in the head telephone. Now, if a rectifier is connected in the circuit converting these currents into a series of semi-cycles as in the graph O-3, no response will be obtained in the telephone from the individual pulses, because they occur at rates above audition, but since they flow in the same direction, the diaphragm responds to an average effect as shown by the graph O-4. Each spark discharge at the transmitter therefore eventually sends a uni-directional current pulse through the receiver producing one click or sound.

We may contrast the foregoing with the problems involved in the *detection of continuous oscillations.* In the continuous wave system the transmitter aerial radiates a steady stream of waves shown by the graph O-1, Figure 5, and a similar oscillating electromotive force is impressed across the terminals of the oscillation detector at the receiving station. But no response would be obtained in the head telephones, for, as already explained, the frequency of the uni-directional pulses O-3 is above audition. This stream of oscillations may, however, be interrupted

*The student should compare the relative time periods of the graphs of figure 4. For the audio frequency charging current of O-1 the period of one cycle is $\frac{1}{500}$ of a second; for the individual cycle of the current impressed

across the oscillation detector as in O-2 from $\frac{1}{25,000}$ to $\frac{1}{1,000,000}$ of a second, the periods vary in fact as the *inductance* and *capacity* of the oscillation circuit. The frequency of the telephone current of O-4 is 1,000 per second, but the duration of each pulse is not necessarily $\frac{1}{1,000}$ of a second, for obviously its duration will vary as the number of cycles in each group of radio frequency currents. (The actual number of cycles per spark depends upon the damping of the circuit. Nevertheless, the telephone will be energized 1,000 times per second).

at the receiving station say 1,000 times per second by some form of the tikker as shown by graph O-2. Groups of rectified currents will pass through the telephone as indicated by the graph O-3 and the resulting telephone current will be that shown by graph O-4.

It is evident that in the first case (Figure 4), the radiated energy is modulated to an audio frequency by the audio-frequency charging current, but in the second case (Figure 5), this audio frequency variation is effected at the receiver.

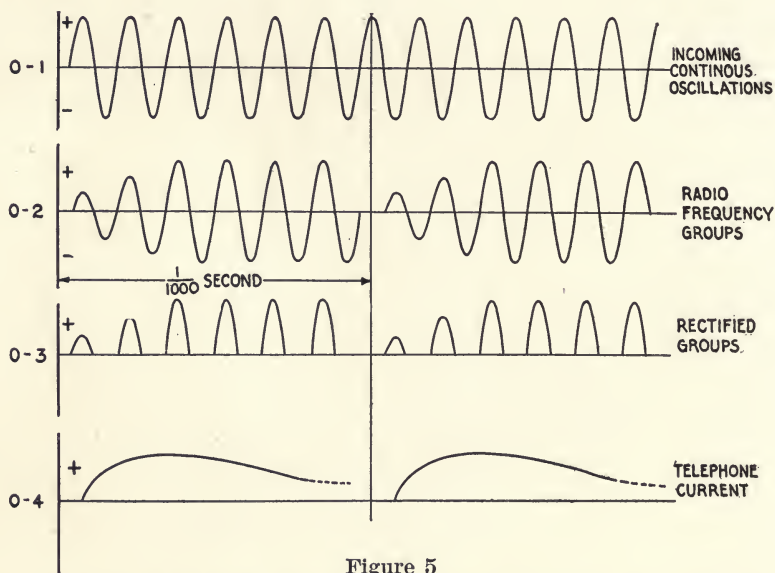

Figure 5

Graphs illustrating how continuous oscillations may be made audible in a receiving telephone.

3. RECEIVER CIRCUITS.—In general, a modern radio receiving set comprises two fundamental circuits*:

- (1) the open circuit;
- (2) the closed or secondary circuit.

The *open circuit* embraces all apparatus from the antenna to the earth connection including usually, an *aerial tuning inductance*, the *primary winding* of a tuning transformer, and a *series variable condenser*.

*Single circuit receiving systems have had some use but the "two circuit" receiver is generally preferred. Three tuning circuits are recognized in connection with the vacuum tubes, known as the primary, secondary and tertiary circuits.

The *secondary circuit* contains the *secondary coil*, the *shunt secondary condenser*, and some form of *oscillation detector* for transforming radio frequency currents into a wave form which will give maximum response in the telephone.

A representative circuit is shown in Figure 6. $L-1$ is the primary winding of a receiving transformer which acts inductively upon the secondary winding $L-2$. $L-3$ is the antenna tuning inductance, and $C-3$, the short wave condenser. The winding $L-2$ is shunted by a condenser $C-1$ of variable capacity, which consists of a number of interleaved plates one set of which is stationary and the other movable.

The secondary system further includes the *rectifier* D , the *telephone* P , and the *shunt condenser* $C-2$. If turns be added at coil $L-1$ or $L-3$

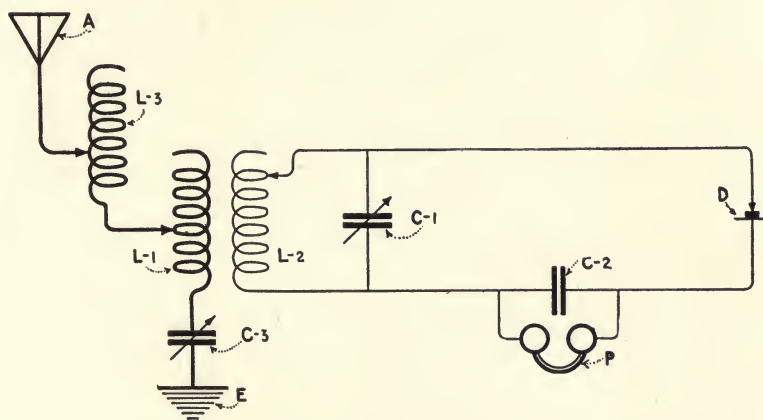

Figure 6

Circuits of the inductively coupled or two circuit radio receiver.

(the aerial tuning inductance), the receiving aerial responds to longer wave lengths, but if turns be subtracted at either this or the primary inductance, $L-1$, the aerial responds to shorter wave lengths. Waves less in length than the natural wave length of the aerial can be tuned to resonance by inserting the condenser $C-3$ in series with the aerial system.

When radio frequency currents flow through $L-1$, an alternating magnetic field of similar frequency cuts through $L-2$ and currents of like frequency flow in circuit $L-2$, $C-1$, which is tuned to resonance to the incoming signal. An oscillating electromotive force is therefore impressed across the detector D , producing a rectified current. The head telephone P , then, is traversed by uni-directional currents.

The open and closed circuits in this diagram are *inductively coupled*.

Conductive or direct coupling may be employed as in Figure 7, or so-called *electrostatic coupling* as in Figure 8. In Figure 7, coil $P-1$ acts as an *auto transformer*, but in Figure 8, coils $L-1$ and $L-2$ are said to be electrostatically coupled through condensers $C-1$ and $C-2$. An *open circuit* secondary may be employed as in Figure 9. This circuit is of par-

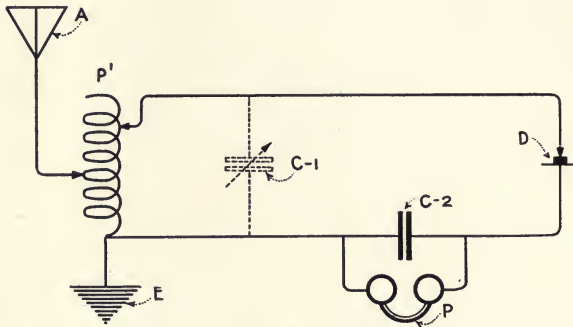

Figure 7

Circuits of the conductively or direct magnetically coupled receiver. A single coil $P-1$ is employed to transfer energy from the antenna to the detector circuits.

ticular advantage for use with oscillation detectors whose response is dependent upon the *voltage* impressed by a given group of oscillations. As it is well known maximum potential is secured at the free end of $L-2$ for a given group of oscillations, by tuning the circuit $L-1$, $L-2$, D , P , to the frequency of the incoming oscillations. Response is secured in

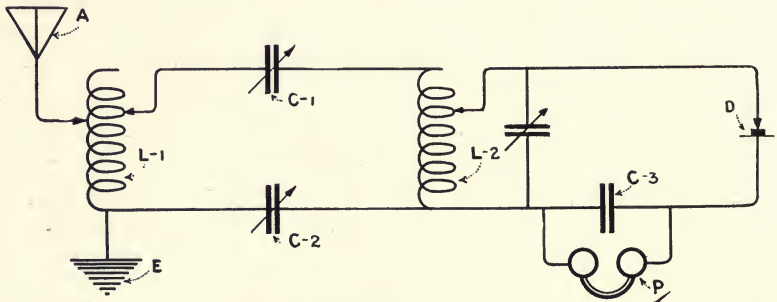

Figure 8

The electrostatically coupled receiver. The primary and secondary tuning coils $L-1$ and $L-2$ are said to be electrostatically coupled through condensers $C-1$ and $C-2$.

the same way as in systems having a strictly closed circuit. But owing to the increased voltage applied to the detector, amplification of the incoming signal is secured.

(a) **The Necessity for Tuning.** It is essential for best results in any two circuit receiving system, that the *open* and *closed oscillation circuits* (or the antenna and detector circuits) be tuned to exact resonance, for it is under this condition only, that the oscillating electromotive force impressed across the terminals of the detector reaches its

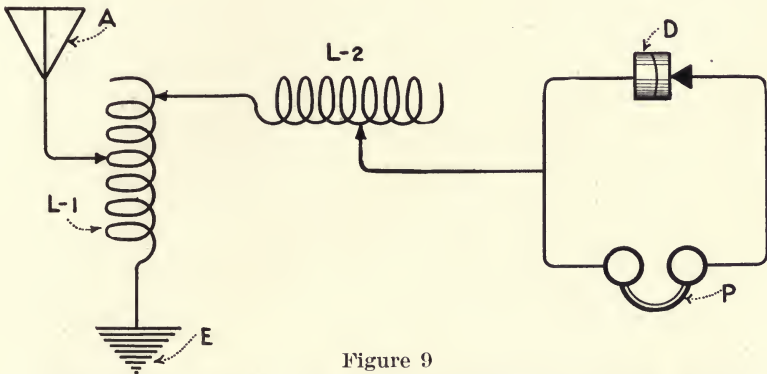

Figure 9

Showing the use of open circuit oscillators in wireless receiving systems. The circuit from detector D through coil L-2 and coil L-1 to E is tuned to the frequency of the incoming oscillations or adjusted until maximum potential exists at the free end of L-2.

maximum value. If the energy consumption of the detector is large, less exactness of tuning may give good results, but approximate resonance is required in all cases unless the distance is short or the received energy very large.

To tune an oscillation circuit to a given impressed frequency, it is necessary to reduce its reactance to zero for the frequency of the incoming signal. This is substantially what the operator at the receiving station does when he adjusts the receiver for maximum strength of signals, that is, he makes the reactance of the capacity equal to the reactance of the inductance for a given impressed frequency of oscillation. The amplitude of the receiver current is then governed solely by the impressed electromotive force and the total equivalent resistance of the circuit (including all losses).

Such tuning is accomplished by *variable inductances* and *variable condensers*. A variable condenser may be of the *interleaved flat type* shown in Figure 10, or of the *tubular type* shown in Figure 11. The majority have air dielectric. In one type the plates are separated by thin sheets of rubber. The capacity of a variable condenser for receiving purposes rarely exceeds .01 microfarad, more common values being .0005 to .005 microfarads.

Tuning inductances are generally of the single layer type varying from one micro-henry to three or four milli-henries inductance. *Multi-layered* coils have found some use, but their self-capacity between layers

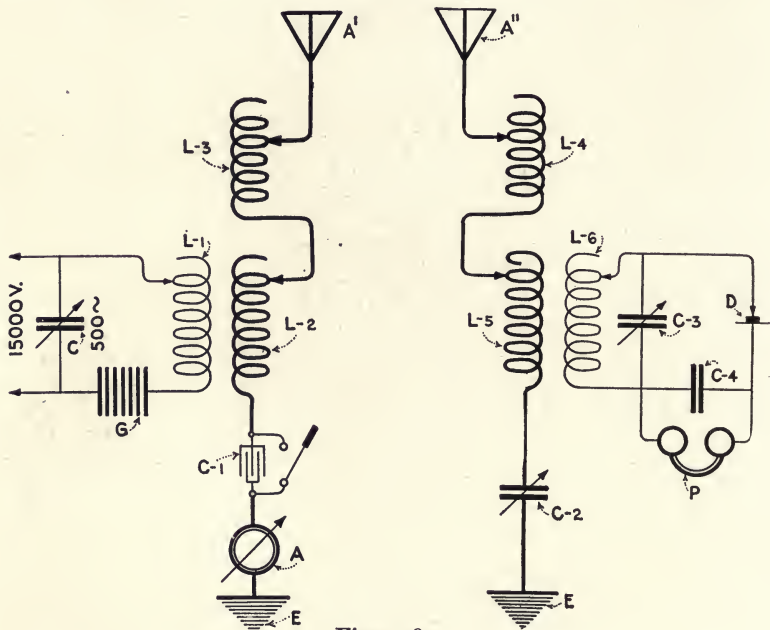

Figure 9a

Diagrammatic sketch of the complete radio frequency circuits of the transmitter and receiver in a wireless system. The closed oscillation circuit of a transmitter is represented by the condenser C, the primary coil of the oscillation transformer L-1, and the spark gap G. The secondary or antenna circuit comprises the aerial A¹, the secondary coil L-2, the antenna loading inductance L-3, the short wave condenser C-1, and the aerial ammeter A.

The circuit of the receiving apparatus is designated by the antenna wires A^{''}, the antenna loading inductance L-4, the primary winding of the receiving transformer L-5, and the short wave variable condenser C-2. The secondary or closed circuit includes the secondary coil L-6, the shunt variable condenser C-3, the rectifier D, the head telephone P, and the shunt telephone condenser C-4.

The condenser C of the transmitter is generally charged 1000 times per second by a 500-cycle alternator and transformer. 1000 sparks discharge across the gap G per second and 1000 groups of radio frequency oscillations are released in the closed circuit C, L-1, G. Coil L-1 acts inductively upon coil L-2 and groups of oscillations of similar frequency flow in the antenna circuit A¹, L-3, L-2, C-1, A, provided this circuit is tuned to resonance. As the transmitter antenna oscillates, it radiates an electromagnetic wave motion which acts upon the receiving antenna circuit A^{''}, L-4, L-5, C-2, E, which is carefully tuned to resonance with the transmitter. The coil L-5 acts inductively upon L-6, the circuit L-6, C-3 being tuned to resonance by means of condenser C-3. Oscillations of the transmitter frequency flow in the closed circuit where they are rectified by detector D, and made audible in the head telephone P.

This diagram is representative of wireless systems for the production of damped oscillations. It is to be observed that four circuits require tuning, namely, the closed and open circuits of the transmitter, and the closed and open circuits of the receiver. All are tuned substantially to the same frequency of oscillation.

is found objectionable at the higher frequencies. They have, however, been employed with good results at longer wave lengths.

It is now quite common to wind the primary and secondary coils of a receiving tuner in two or more *layers*. A maximum of inductance is

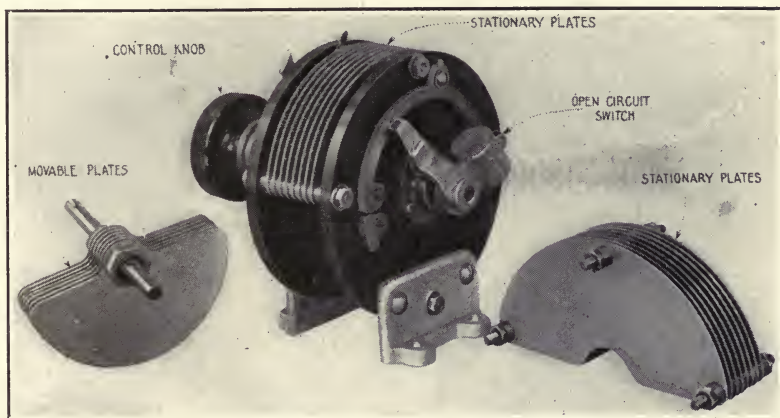

Figure 10

A variable condenser of the multiple plate type as used in tuning receiving circuits.

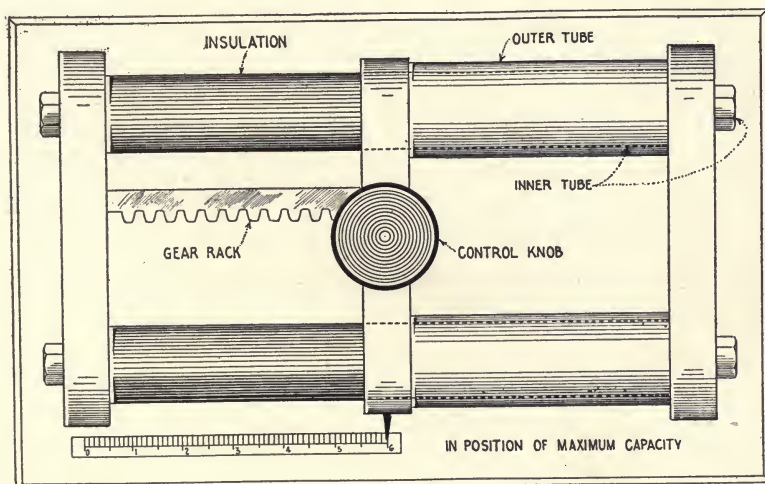

Figure 11

A variable condenser of the tubular type.

thus obtained with a minimum of resistance. A multi-point inductance for tuning purposes is shown in Figure 12. In this diagram, the switch marked "Units" cuts in single turns in the circuit, and the switch marked "Tens" cuts in ten turns at each contact point.

(b) **Tuning in Practice.** To adjust a receiver for maximum response from a given transmitter, the operator first tunes the *closed or secondary circuit* to the desired wave length, and then couples closely thereto the *antenna or primary coil*. He then increases or decreases the inductance or capacity or both simultaneously, in the antenna circuit until the

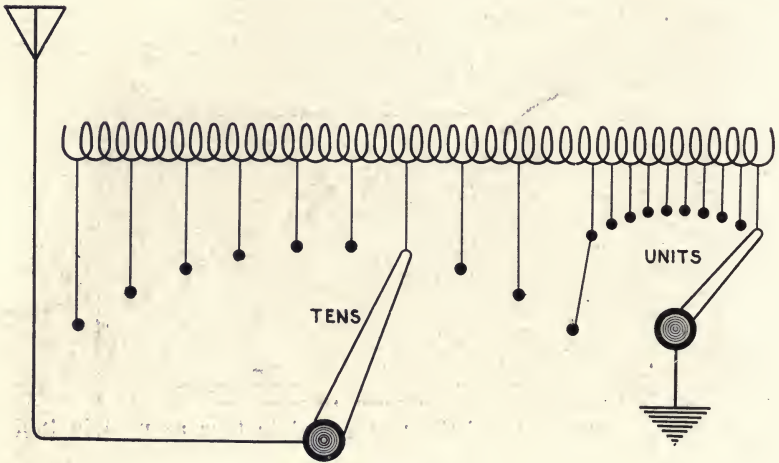

Figure 12

Showing how the inductance of a radio frequency coil may be varied from one turn to maximum through the use of two multi-point switches. In this diagram the switch marked "Units" cuts in single turns, and the switch marked "Tens," ten turns in a group. For example, if one turn is cut in at the "Units" switch and ten turns at the "Tens" switch, the circuit will include eleven turns.

desired signal is heard. If the receiving apparatus has been calibrated by a wave meter, all the necessary tuning can be done before the transmitting station begins operation.

Selectivity in wireless receiving apparatus, that is, discrimination between stations, is secured:

- (1) by loose coupling of the primary and secondary circuits;
- (2) by the use of large values of inductance at the base of the aerial for a given wave length;
- (3) by judicious use of the shunt secondary condenser.

The tuner may be adjusted for *broad tuning* (response from several transmitters simultaneously) by closely coupling the primary and secondary circuits. This increases the natural damping of the system and the complete circuit will therefore respond over a range of frequencies without requiring accurate adjustment. On the other hand, loose coupling of the open and closed circuits permits sharp tuning, that is, the receiver responds with vigor to oscillations of a single frequency, and the more exact the resonance the better the signal.

4. THE TELEPHONE RECEIVER.—The simple magnetic telephone receiver is universally employed to detect the currents induced in the wireless receiving aerial by the distant transmitter. Certain phenomena connected with its operation have been touched upon in paragraph 1, but will now be considered more in detail.

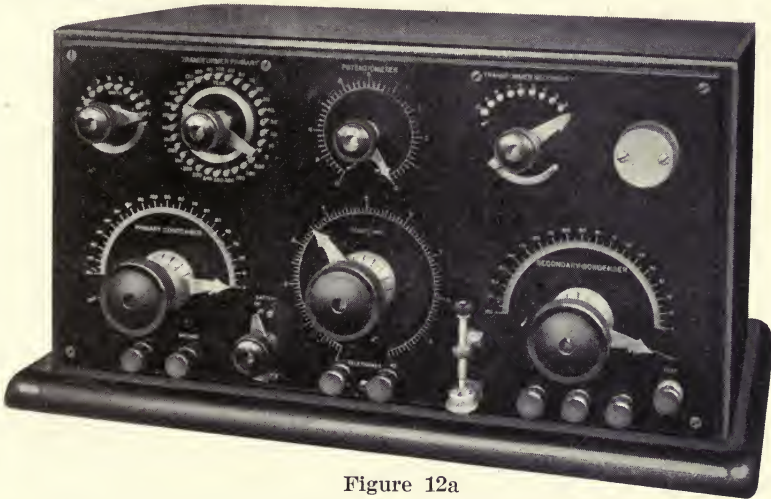

Figure 12a

Front view of the American Marconi Co.'s type 106 receiving tuner. All tuning apparatus is mounted on the front of the panel board convenient to the operator.

This tuner is of the inductively coupled type and is fitted with a carborundum detector. The wave length is variable between 200 and 3,500 meters.

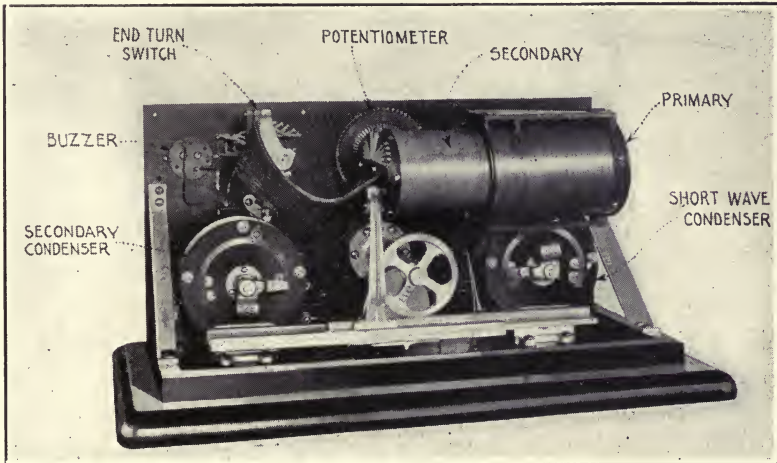

Figure 12b

Rear view of the type 106 tuner, showing the tuning transformer, variable condensers, potentiometer, and buzzer tester.

In the diagram of Figure 13, the bobbins of the telephone magnet windings are indicated at B-1 and B-2, the cores of which are permanently magnetized by the horseshoe or ring magnet *M*.

If direct current flows between *A* and *B* in one direction it strengthens the total magnetic field and *D* is drawn down further, but if the direction of the current is then reversed, the total field acting on *D* is decreased and the diaphragm is released by an amount depending upon the demagnetizing effect of the current.

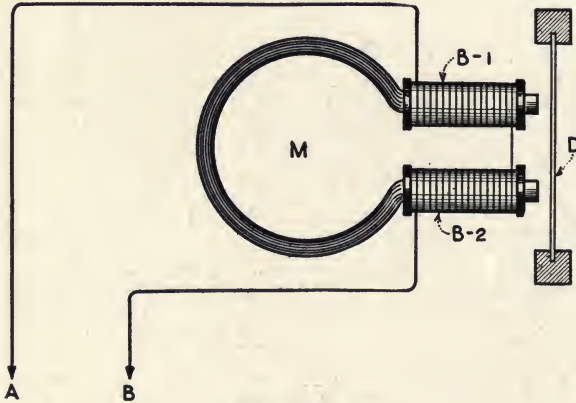

Figure 13
Showing the fundamental construction of the telephone receiver.

If an alternating current passes through the receiver winding, similar effects are observed, that is, a cycle of current will cause the diaphragm to go through the movement outlined in the preceding paragraph.

It is now quite clear that if we desire to set the diaphragm into motion or produce sound, we must supply to the telephone a current that varies in amplitude. This current may be a fluctuating direct current, a sinusoidal alternating or a complex alternating current. It may be said in general that the receiver diaphragm repeats the variations of any variable E.M.F. but not always without distortion.

Beyond this, currents of a definite frequency will produce more sound with a given minimum E.M.F. than those of other frequencies. The fact is that the diaphragm of a telephone receiver possesses a "natural frequency of vibration," that is, if deflected to one side momentarily and released, the diaphragm will vibrate at a rate determined by its *mass* and *elasticity*.

If the receiver is actuated by an alternating current of sinusoidal

form, and of variable frequency, the diaphragm will vibrate most strongly when the *impressed frequency* equals the *natural frequency* of the diaphragm. This, for the average telephone used in wireless telegraphy is near to 1000 cycles per second, but, of course, it varies with the construction of the receiver.

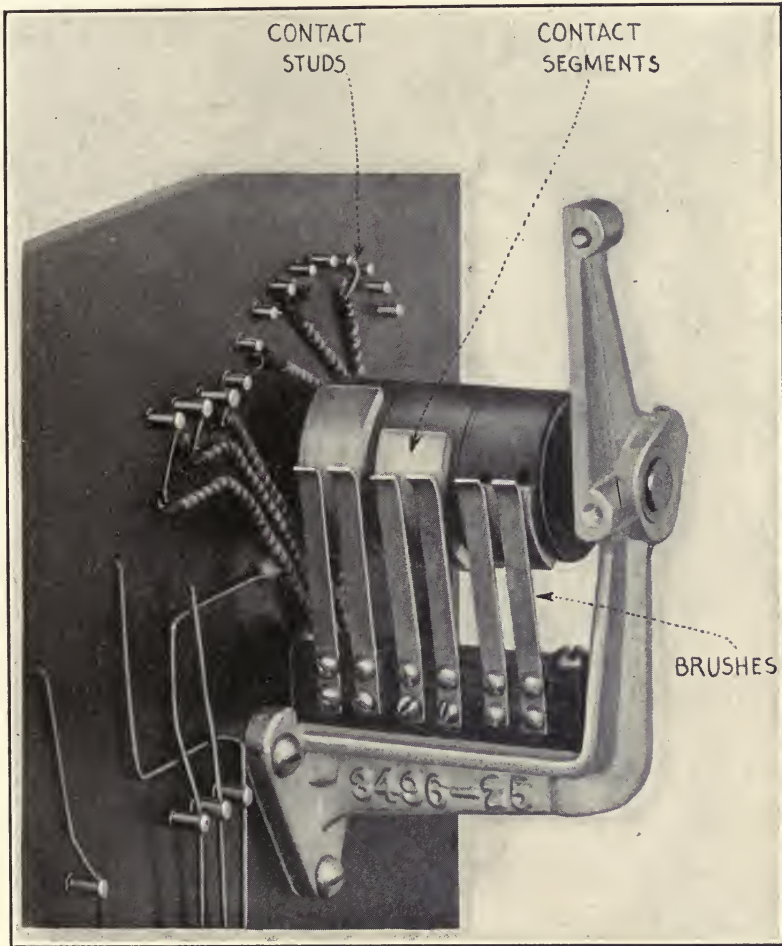

Figure 13a

Showing the end turn switch employed in the primary and secondary circuits of the Marconi type 106 tuner. This switch divides the tuning coils into groups to eliminate end turn losses.

The important point to be brought out here is that when the frequency of the applied current is such as to impulse the diaphragm more than 1000 times per second, its motion as the frequency is increased

becomes less and less audible for a given E.M.F. until at frequencies above 20,000 cycles per second no sound appreciable to the human ear is obtained.

In the receiving circuits of commercial wireless telegraphy, as we have already mentioned, alternating currents flow at various frequencies between 20,000 and 1,000,000 cycles per second; hence, we see at once the futility of using the telephone receiver as a sound indicator of radio frequency oscillations.

Then we can obtain sound in the telephone from incoming radio frequency currents only by employing a device which will convert such currents into some form of an audio frequency current that will give a response in the head telephone.

Just how this is accomplished in the Fleming oscillation valve will be described in the chapter following.

PART I

THE OSCILLATION VALVE IN RADIO TELEGRAPHY

5. FOREWORD.—The student about to take up the profession of a commercial or government wireless operator often is confused by the seeming complication of circuits encountered in connection with the operation of the vacuum valve. Moreover, he is confronted with a new terminology and a glittering array of trade names for vacuum tubes of different construction.

Although the oscillation valves employed in wireless telegraphy are known in the art under various trade appellations, the author will employ the terms "*vacuum valve*," "*vacuum bulb*," "*vacuum tube*," or "*vacuum tube detector*" interchangeably.

It is not the purpose of this volume to discuss the relative merits of the various types of vacuum tubes, or to go deeply into their construction, but an effort will be made to present in simple language the conclusions arrived at by the inventor of the oscillation valve, Dr. J. A. Fleming, and by various investigators of prominence, among whom may be mentioned Captain Edwin H. Armstrong, Roy A. Weagant, and Dr. Irving Langmuir. A further object is to show the radio operator the circuits and functioning of the valve in practice.

In order to present the subject in a simple manner, the author has deviated slightly from strict scientific terminology and mode of presentation, but now that the motive for so doing is made known, due allowance will be made by the expert engineer.

It would be well to keep in mind that the vacuum tube can be employed to *detect* the passage of high frequency currents through the medium of a telephone, or it may act as a *generator* of radio frequency currents for the purpose of *wireless communication*. Both uses will be treated but the text will bear particularly on the use of the valve as an oscillation detector in wireless telegraphy.

6. WHAT IS AN ELECTRON?—The vacuum tube when used as an oscillation detector in radio is frequently called an Electron Relay and the term implies that electrons are useful agents in its operation; hence the question naturally arises in the mind of the student, "What is an electron?" Briefly, we may state that the *electron* is the smallest subdivision of matter which mankind recognizes carrying the smallest known charge of negative electricity.

It has been held by science for years that matter is built up of distinct particles or units termed *atoms* and *molecules*. The molecule first was assumed to be the smallest quantity of matter that can have a separate existence or take part in chemical action, but more rigorous research points to the fact that the molecule is made up of smaller elements which are termed atoms; that is, *a molecule may be composed of several atoms*. The atom, then, was assumed to be the very smallest quantity of an element that can exist, but latter day researches have revealed that the atom may be further subdivided into corpuscles or particles termed *electrons*.

The apparent mass of an electron is about one eighteen-hundredth part of that of an atom of hydrogen, which is the smallest of the chemical atoms.

According to the theory now in vogue concerning the ultimate nature of matter, an atom consists of a definite number of electrons grouped about a nucleus having a positive charge, and so long as none of the component electrons are driven from the atom, the latter possess no detectable electrical charge.

But let an electron be detached from the atom, then the atom becomes what is known as a "positive ion" and it exhibits the properties of a positively charged body.

On the other hand, if an electron is added to a normal uncharged atom, the latter, in this state, possesses a negative charge and is termed a "*negative ion.*" In summary, the *positive ion* possesses a *deficiency of electrons* and the *negative ion* an *excess of electrons*.

Although a number of congregated electrons go ultimately to make up a particle of matter, we should not conceive of electrons in terms of matter as we ordinarily understand this term in solids. Rather must we think of electrons in terms of electricity, and in this way we can comprehend in some measure the extreme mobility which they possess as compared to "solid bodies."*

In the original sense of expressing "positive" and "negative"

*For an interesting article on modern conceptions of the electron see the paper, "Modern Physics," *Proceedings of the American Institute of Electrical Engineers*.

charges of electricity an *electron constitutes a negative charge*. In fact, when a number of electrons are detached from any atom we say that there has been a movement of *negative electricity*, and we should now accept the statement that the *flow of electricity is a movement of electrons*.

Electrons may act as carriers of electricity between two conductors separated in vacuua. Some of the present theories as to how they are made use of in the vacuum tube oscillation detectors of radio telegraphy we shall describe and explain further on.

7. HOW MAY ELECTRONS BE SET INTO MOTION?—We have stated in effect that in order to liberate electrons we must disrupt an atom. Of the various methods for disrupting an atom the one employed in the vacuum valve tubes will be given consideration.

It has been known for many years that the space about a heated metal is a conductor of electricity. It has been demonstrated more recently that it is due to the release of electrons and that if an incandescent metal is placed in a bulb exhausted of air or gases, pure *electrons* are liberated from the metal. This is the most convenient method for driving electrons from a metallic body for use in connection with oscillation detectors, and as stated before, the other methods for doing this will not be discussed.

For any useful result the vacuum employed must be of a high order, approximating that of an incandescent lamp or better, as the presence of any considerable quantity of gas either prevents or greatly interferes with a useful action.

8. FLEMING'S DISCOVERY.—The first to employ the emission of electrons from heated metals, to rectify or to detect radio frequency oscillations in a wireless telegraph receiving system, was Dr. J. A. Fleming, of London, England. He named his product a *glow lamp oscillation detector* or *oscillation valve*, the latter name being adopted because he found that the lamp would conduct electricity better in one direction than in the opposite direction. Hence, if the valve was connected in series with a source of radio frequency oscillations, one-half of each cycle was suppressed, the circuit being traversed by a pulsating direct current. The flow of such currents could then be detected by a telephone receiver or a sensitive direct current instrument such as the galvanometer. In more scientific terms the glow lamp was found to possess unilateral conductivity or *assymetric resistance*.

This discovery marked a most important step in the progress of the radio art. Immediately the results of Fleming's investigations were published, intense interest was aroused throughout the scientific world,

and simultaneously a steady commercial application of the vacuum valve as a detector of electric waves took place.

9. THE OSCILLATION VALVE.—One form of Fleming's oscillation valve for use as an oscillation detector in wireless telegraphy is shown in Figure 14.

A carbon filament *F* brought to incandescence by a small storage battery is surrounded by a metallic cylinder *P* such as copper or nickel. Later types of Fleming's valves employed a tungsten filament and a copper cylinder, or in place of the latter, a small metallic plate.

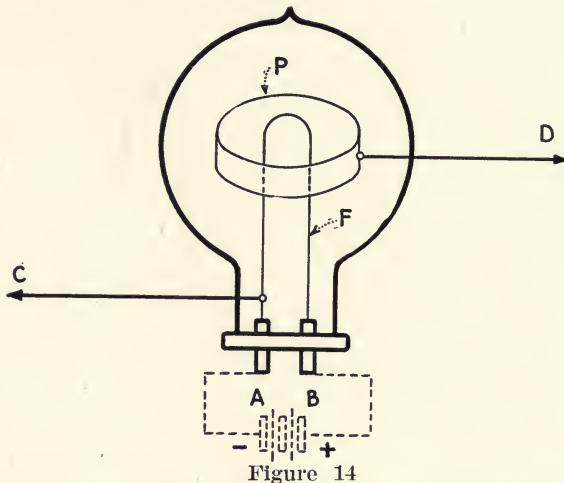

Figure 14
Fleming's oscillation valve in a simple form.

In order to secure the valve effect the terminals of the filament first must be connected to a 4 or 6 volt battery, the degree of incandescence being carefully adjusted by a series rheostat. The filament then emits electrons. The current to be rectified, is next impressed upon the terminals *C*, *D*, that is, *C*, *D*, are connected in series with the circuit in which the valve effect is desired.

Certain phenomena bearing upon the action of the valve as an oscillation detector are summed up in the following statements:

- (1) The filament *F* when heated emits electrons;
- (2) These electrons can be drawn to the cylinder or plate *P* by charging the plate to a positive potential;
- (3) When electrons are drawn to *P*, the vacuous space between the filament and the plate is conductive in one direction only, i. e., a battery current, for instance, can flow from the plate *P* to filament *F*, but not in the opposite direction;
- (4) The amount of current that can be passed from the plate to filament is definitely limited for a given set of conditions.

The student should give this preliminary outline of action careful study.

Now any device which will pass a current of electricity in one direction and will wholly or partially obstruct the flow in the opposite direction may be termed a "rectifier," because if it is connected in the path of an alternating current, it will suppress one-half of each cycle and therefore the circuit will be traversed by a *pulsating direct current*.

A rectifier also is said to possess "*unilateral conductivity*," meaning, of course, that it will conduct electricity in one direction only. Its ability to rectify currents of extremely high frequency is one of the important properties of the oscillation valve. The part which the rectifier plays in the detection of wireless signals has been mentioned in paragraph 2, but it will be treated more in detail in Part II. The electron current in the valve will be given the first consideration.

10. DEMONSTRATION OF RECTIFYING PROPERTIES.—

The rectifying properties of the vacuum tube can be demonstrated by the apparatus indicated in the diagram of Figure 15. Here, filament F is lit to incandescence by battery $B-1$ of 4 to 12 volts. An E. M. F. variable up to 100 volts or more is applied between F and P by battery $B-2$. A milliammeter shown at A is connected in series with $B-2$. As

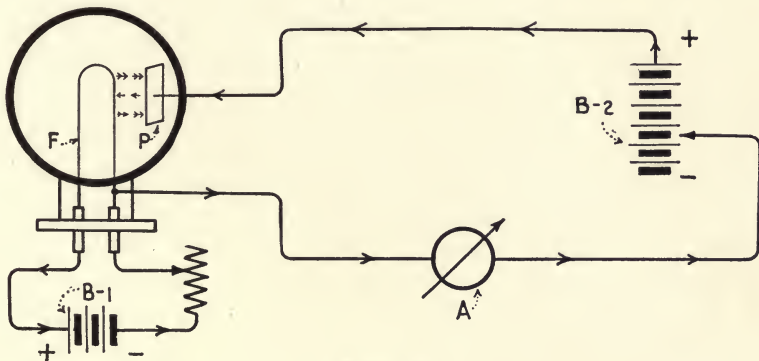

Figure 15

Apparatus for demonstrating the rectifying properties of the two-electrode oscillation valve.

stated under (2), paragraph 9, it is by thus charging plate P to a positive potential that electrons are drawn over from the filament.

In this experiment, meter A will register only when the positive terminal of battery $B-2$ is connected to the plate. If connected in the opposite way, little or no current will flow. Hence, if an alternating E. M. F. is impressed across F and P , current can flow from P to F only

when P is charged positively. The tube thus becomes a *rectifier of alternating currents*, and will perform this function at any frequency up to *several million cycles per second*.

Now, merely as a matter of illustration, we have represented (in Figure 15) the passage of the electrons which are attracted to the plate P from filament F by double pointed arrows and the current supplied by battery $B-2$ which flows from plate P to filament F by single pointed arrows. At first sight there may appear to be two forces acting against each other, but the seeming contradiction can easily be explained.

The assumption that electricity flows from a point of positive potential to one of negative potential was made and accepted by scientists many years before there was any knowledge as to what a flow of electricity is, but since the introduction of the electron theory (keep in mind the fact that electrons are *negative charges of electricity*) it is necessarily assumed that the transfer of electricity takes place in the direction from the *negatively charged body to the positively charged body*.

It will prevent confusion at the outset, then, if the student understands that in conformation with the old theory electricity *flows in the direction opposite to the flow of the electrons*.

Now, to withdraw electrons from the filament F to the plate, the latter must be charged to a positive potential. Thus, it is evident that electrons flow from the filament to the plate by virtue of the *electrostatic field* maintained by the battery $B-2$. The strength of this field, of course, varies with the E. M. F. of $B-2$. If, on the other hand, P is charged negatively, the electrons are driven back to the filament and the current will be reduced to zero.

11. NON-UNIFORM CONDUCTIVITY OF THE VALVE.—

The rectifying properties of the tube have been treated in the preceding paragraph. With the connections of Figure 15, it can also be shown that the conductivity of the space between P and F is not a constant in the direction in which it conducts more freely, *i. e.*, the apparent resistance varies with the applied E. M. F.

More clearly if the valve is placed in series with a source of current the complete circuit will not obey Ohm's Law. Just as in the case of the carborundum rectifier,* if battery $B-2$ of Figure 15 is shunted by a potentiometer, and the voltage is steadily increased from a small value to some upper limit of the battery, the readings of the meter A will not accord with Ohm's Law.

During the first increase in voltage, the reading of the current will be low, indicating a high value of resistance, and after a more or less

*See pages 137, 138, 139 author's "Practical Wireless Telegraphy."

critical point is passed, the current (in micro- or milli-amperes) will rapidly increase, indicating a much lower resistance. The current-voltage readings thus obtained can be plotted in the form of a curve as in Figure 16. Up to the point *A* on the curve an increase of E. M. F. of the bat-

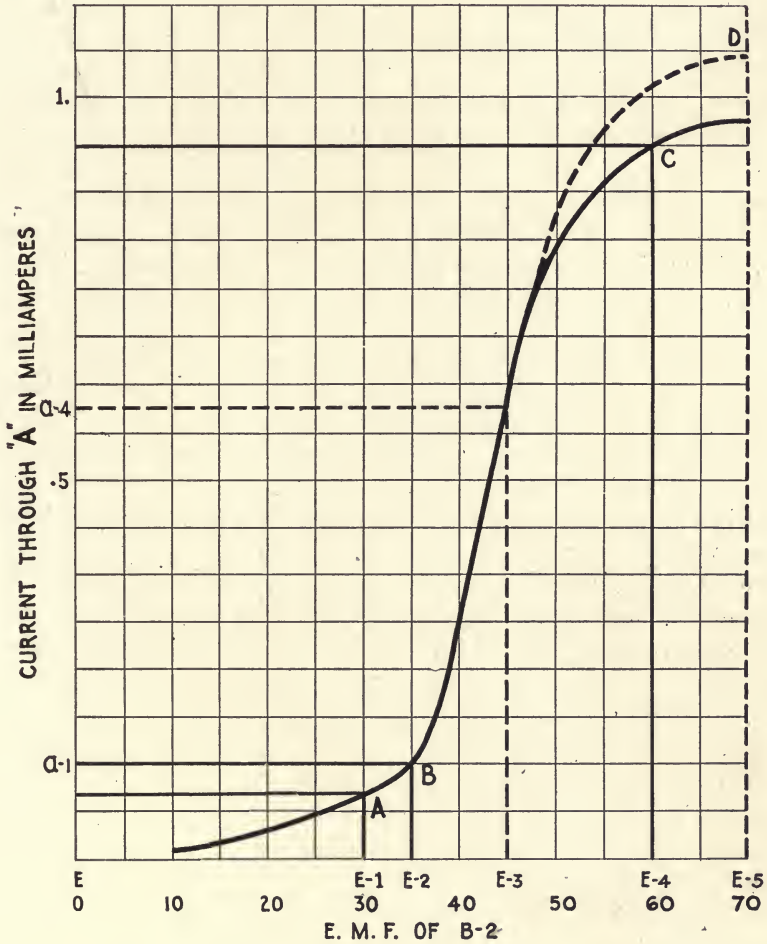

Figure 16
 Characteristic curve of two-electrode Fleming valve, indicating the strength of the electron current with different values of plate potential.

tery *B-2* results only in a *slight increase* of current as shown by the readings on the vertical axis. But if the voltage be increased from *E-1* to *E-3* or *E-4*, the current in the plate circuit rises very rapidly. From point *C* on, there will be no further increase of current with increase of the plate E. M. F. At this point the valve is said to be *saturated*.

If the data obtained in this experiment, plotted on cross-section paper, gave a straight line instead of a curve, then Ohm's Law would be obeyed, and the valve would possess uniform conductivity, but since the curve shows that it does not obey Ohm's Law, the valve possesses *non-uniform* conductivity.

The curve of Figure 16 is then called the "*characteristic*" curve of the valve and the adjustment of the plate current to the so-called *critical point* on the curve during the reception of signals renders it, through the medium of a telephone, a sensitive indicator of feeble radio frequency currents such as flow in the receiving circuits of a wireless telegraph system.

The critical point on the curve is usually on the lower bend but response can be secured at the upper bend as well; or under certain conditions, other points on the characteristic curve may be employed in radio reception. This will be treated more in detail further on.

12. HOW THE VALVE BECOMES SATURATED.—The strength of the electron current flowing from *F* to *P* is limited in two ways: First, by the *temperature limitation of the filament*, and second, by the so-called *space charge*. At point *C* in the curve of Figure 16, the increase of current through the valve falls off rapidly. Any further increase in E. M. F. of *B-2* gives no further increase of current. At this point the valve is saturated.

It would be well at this juncture for the student to understand that the amount of current passed per second from plate to filament varies directly with the supply of electrons. In fact, it is assumed that 10^{19} electrons passing from *F* to *P* per second are the equivalent of one ampere. As mentioned above, the *first limitation* is found in the supply of electrons given off by the filament, which varies with the *temperature*. Only the equivalent current of this supply of electrons can flow no matter how much we *increase* the E. M. F. of *B-2*.

Then, to increase the electronic emission, we must increase the temperature of the filament provided the maximum permissible temperature has not been reached. If the E. M. F. of *B-2* be then increased a new curve *A, B, D* (Figure 16) will be obtained, *i. e.*, the electron current from *F* to *P* will increase. Further increase of the E. M. F. of *B-2* gives another point of *saturation D*, and no matter how much the E.M.F. of *B-2* is raised no increase of current will result because all of the electrons available have been drawn to the plate.

We might state this in another way by saying that the electrons are attracted to the plate by the electrostatic field (between the plate and filament) maintained by battery *B-2*, and if the temperature of the fila-

ment is fixed we need only increase the voltage of *B-2* to that value necessary to draw over all the electrons given off by the filament, if we want the maximum current to flow. Further increase of the E. M. F. of *B-2*, as stated before, will not increase the electron current because no more

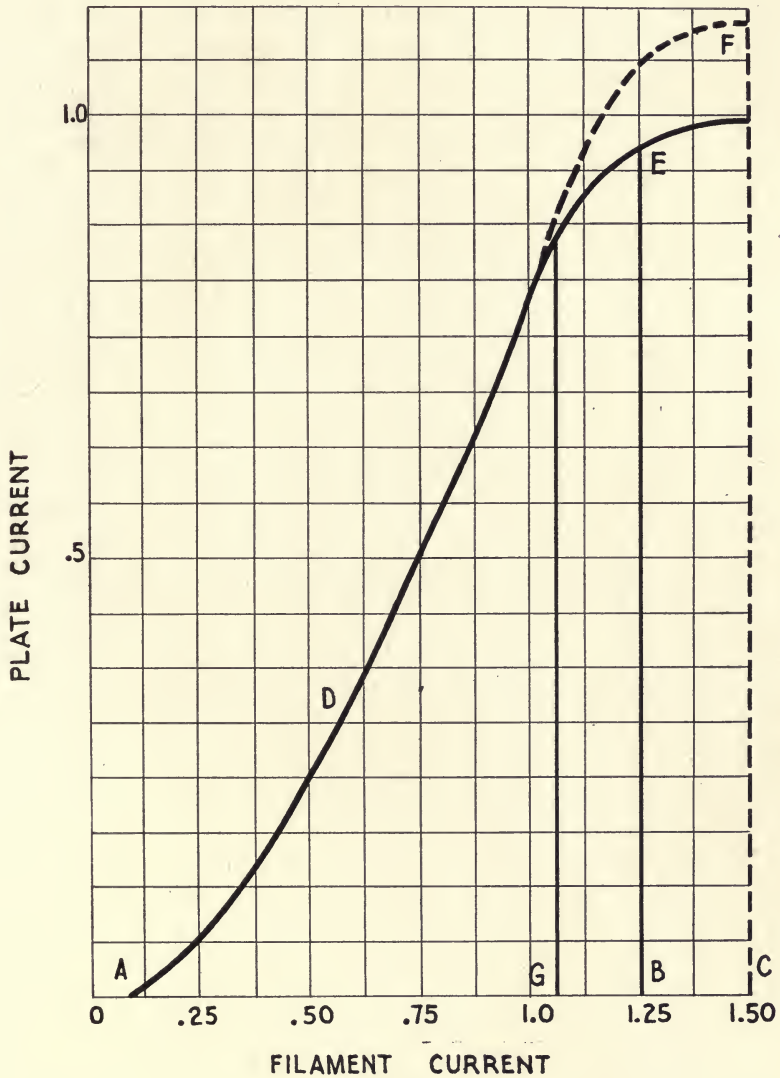

Figure 17

Characteristic curve of two-electrode valve showing how the plate current varies with different degrees of filament temperature, the potential of the plate being held constant.

electrons are available. Thus we see that the plate current is limited by the *temperature of the filament*.

In addition to the restricted plate current due to the filament temperature limitation mentioned above, Dr. Langmuir declares* that the plate current is limited for a given plate voltage by reason of the *space charge* within the bulb. He remarks that the electrons flowing between the filament and plate constitute a *negative electric charge* in space which repels the electrons escaping from the filament, causing some of them to return to the filament; that is, only a part of the electrons emitted by the filament reach the plate, the remainder being repelled by the electrons in space and they therefore return to their source.

More clearly, if the plate voltage is fixed and the filament temperature is steadily increased, a condition will be reached where an increase of filament temperature will not result in an increase of the plate current on account of the space charge. Then, to increase the plate current it becomes necessary to increase the voltage of the plate battery.

The space charge can also be diminished by altering the construction of the bulb, *i. e.*, by bringing the plate and filament closer.

Another curve, Figure 17, will serve to make clear the relation between a progressive *increase of current through the filament* with a *definite* value of E.M.F. at *B-2* and the corresponding *current in the plate circuit*.

If the temperature of the filament is progressively increased, then a curve *A, D, E*, is obtained. The curve indicates that at point *E*, the space charge tends to neutralize the electron current. In other words, the plate current increases with increase of filament temperature from *A* to *G*, but falls off rapidly from *G* to *C*.

If the filament temperature exceeds *A, G*, and the E.M.F. of *B-2* is increased, a new curve *A, D, F*, is obtained, which indicates the flow of an increased current through the plate circuit. It is clear from Figure 17 that if the filament current is less than *A, G*, the current in the plate circuit will not increase with increase of the E.M.F. of *B-2*, Figure 15.

**Proceedings of the Institute of Radio Engineers*, Sept., 1915, pages 268 and 274.

PART II

PRACTICAL APPLICATIONS OF THE OSCILLATION VALVE

13. **IN GENERAL.**—We have established four important facts concerning the vacuum tube and the telephone receiver:

- (1) The tube is conductive in one direction and therefore may be employed as a rectifier of alternating currents; i. e., it possesses assymetrical conductivity.
- (2) A characteristic curve of the tube shows that it does not, in respect to conduction, obey Ohm's law; i. e., its resistance varies with the applied E. M. F.
- (3) The telephone receiver will not give audible response to radio frequency currents (currents in excess of 10,000 cycles per second).
- (4) By means of a rectifier, radio frequency currents occurring in audio frequent groups (damped oscillations) can be converted to decaying direct currents which, if they flow through the telephone, will give audible response. (See paragraphs 2 and 9.)

These four statements will assist the student to understand how the incoming radio frequency oscillations in a wireless receiving system are translated into audio frequent currents to energize the head telephone. It is the function of the oscillation valve to effect this conversion.

14. **ACTION OF THE SIMPLE VALVE.**—In order to make clear the functioning of the simple valve as a detector of radio frequency currents, there is reproduced in Figure 18a, the characteristic curve shown in Figure 16, and in Figure 18b, a circuit for demonstrating experimentally the "*valve action.*"

A, B, are the brushes of an alternating current generator. *B-1* is a battery of 4 volts to incandescence the filament. *B-2* is a second battery to charge the plate *P* to draw electrons from the filament. The charge on *P* is varied by potentiometer *P-2*. As in previous diagrams the cur-

rent of *B-2* is represented by the single pointed arrows, and the electrons emitted by the filament with double pointed arrows, and for this particular illustration a single alternation of current from generator *A, B*, is shown by the three pointed arrows.

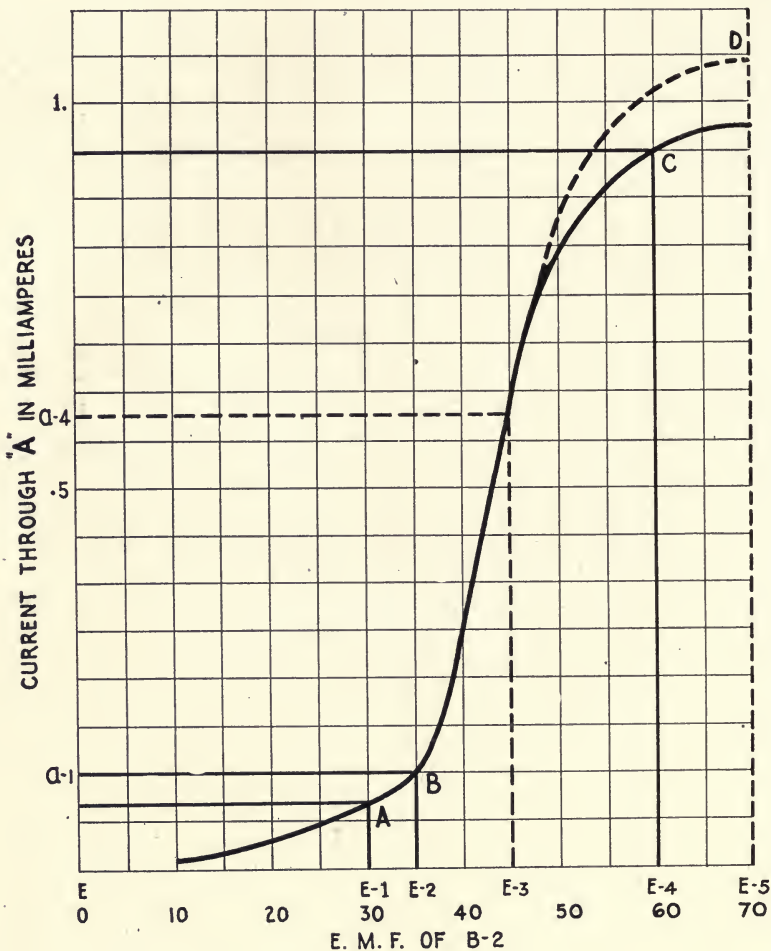

Figure 18a

In harmony with statements in paragraph 13 under (1) current generated by *A, B*, can flow from plate *P* to filament *F*, but not in the opposite direction. Hence, from this action by itself, an alternating current would be changed to a direct current.

But there is another important action here to have consideration.

Direct current from battery $B-2$ flows constantly from plate P to filament F , and during the moment that this current and that of the generator A, B , flow in the same direction there will be a *large increase of current through the telephone P-1*. But if current from A, B , flows opposite to that of the battery there will be a small decrease of current through the telephone.

Just why the telephone current increases to a greater degree than it decreases can be determined from the characteristic curve reproduced in Figure 18a.

Point B on the curve corresponds to voltage $E, E-2$, and to current a_1 ; but if the voltage is increased to $E-3$, the current increases to a_4 .

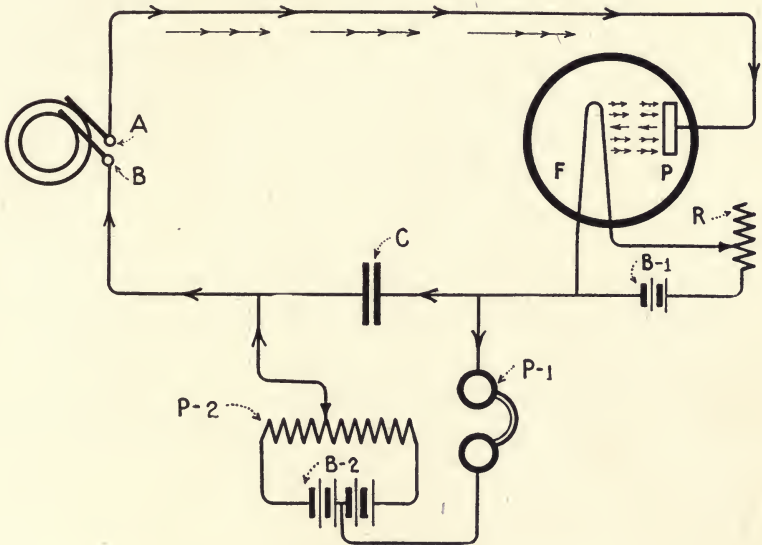

Figure 18b

Apparatus for demonstrating the non-uniform conductivity of the vacuum valve.

From this we see that if the voltage of battery $B-2$ is adjusted to value $E-2$ (whatever it may be) a small increase to $E-3$ will increase the total current flowing through the circuit to some value in excess of a_1 .

Conversely, when the E.M.F. of the alternator opposes the E.M.F. of $B-2$, the total E.M.F. is less, hence the current as read from the curve is slightly less than a_1 .

Now, if we substitute for the alternator a radio receiving transformer, precisely the same action takes place, but in this case there is impressed upon the valve a current of extremely high frequency. The

complete process by which such radio frequency oscillations are made audible in the head telephone can be explained by the curves of Figure 19.

The decaying groups of oscillations on the lower horizontal line *O-1* represent those incoming at a given radio station and the group on the line *O-2* represents the fluctuations or increase and decrease of the tele-

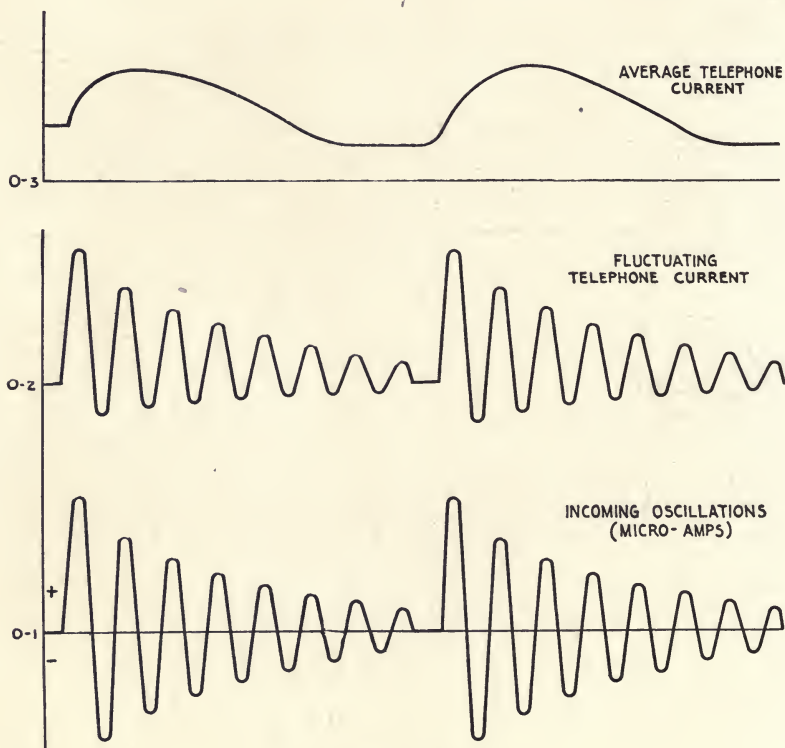

Figure 19

Showing the phenomenon involved in the detection of radio frequency oscillations by the two-electrode vacuum tube. Graph *O-1* indicates the incoming radio frequency oscillations; graph *O-2*, the fluctuating telephone current, and graph *O-3*, the average effect of the telephone current upon the diaphragm.

phone current. But since the increase is much greater than the decrease it amounts in effect to a uni-directional current which actuates the telephone diaphragm at an audio frequency. The telephone diaphragm responds to an average effect of the amplitudes in *O-2*, which, roughly, may be represented by the curves on line *O-3*.

Beginning at the transmitter, the phenomena involved may be summed up as follows:

For each spark at the transmitter the aerial radiates one group of

waves and each group induced in the receiving apparatus is rectified by the valve so that a decaying uni-directional E. M. F. flows through the head telephones, producing one "click" or sound. Therefore, 1,000 sparks at the sending station produce 1,000 clicks in the receiving telephone.

The condenser *C*, in the diagram of Figure 18b, serves to store up the rectified currents. It is generally assumed that it discharges through the head telephone aperiodically.

15. THE PRACTICAL OSCILLATION VALVE CIRCUIT IN RADIO.—The two batteries for the Fleming valve shown in Figure 18b, are not essential to its operation in practice. The battery *B-1* may be employed to render *incandescent the filament* and to *attract the electrons*

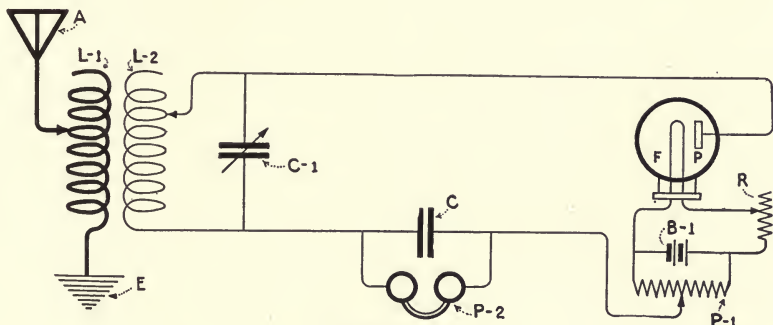

Figure 20

Circuit for the two-electrode vacuum tube as an oscillation detector in radio telegraphy. Current is supplied to the plate circuit by the battery *B-1*, which also incandesces the filament.

from the filament to the plate. The circuit is shown in Figure 20. In this diagram the alternating current generator (Figure 18b) with brushes *A, B*, is replaced by the primary and secondary circuits of a standard radio receiving system. The *aerial* or *antenna* is shown at *A*, the *earth connection* at *E*, the *primary winding* of the receiving transformer at *L-1*, the *secondary winding* at *L-2*, and the *secondary tuning condenser* at *C-1*. The *telephones P-2* are shunted by the *condenser C*, and the *battery B-1* by the *potentiometer P-1*, which is of 400 ohms resistance.

If the sliding contact of potentiometer *P-1* is placed to the right, plate *P* will be charged to a positive potential, the path of the plate current being through telephones *P-2* through the secondary winding *L-2* to plate *P* back to the negative side of filament *F*. But if the contact on *P-1* is placed to the left, the potential of the plate *P* in respect to the negative side of the filament will be reduced to zero.

The apparatus shown in this drawing functions like that in the diagram of Figure 18b, but in this case, there is impressed across the detector an oscillating E. M. F. occurring at a radio frequency. A half cycle of the incoming oscillations flows freely from plate *P* to filament *F*, causing a large increase of current through telephone *P*. The remaining half cycle flows oppositely to the plate current, causing a small decrease in the telephone current. *The net result is an increase of current in one direction through the head telephone.*

To comprehend this clearly, the student must keep in mind the characteristic curve shown in Figure 18a, and note the deductions which may be drawn therefrom. When the operator adjusts the potentiometer *P-1* for the maximum strength of signals, he operates the valve on some point of the characteristic curve where the addition of a slight antenna E. M. F. produces either a large increase or a large decrease of current through the head telephones.

Thus at point *C* (Figures 16 or 18a) the effect of a group of radio frequency oscillations is evidently to cause a decrease in telephone current, but at point *B* the reverse is the case.

Careful study of Figure 18a, reveals the points on the curve to which the plate current should be adjusted for maximum signals under different values of oscillatory E. M. F. supplied by the antenna. If the incoming signals are relatively strong, the plate voltage may be adjusted to a point slightly below the bend of the curve *B*. This increases the telephone current to a greater value than could be obtained further along the curve. But if the incoming signals are relatively weak, the plate potential must be adjusted to a point further along the bend in order that the E.M.F. of the incoming signal may change the plate current sufficiently so that the telephone current will increase to a greater extent than it decreases. The foregoing applies equally well to the upper bend of the curve.

In the parlance of practice, the *plate voltage that will give the maximum strength of signals for strong incoming oscillations generally is not the voltage that will give the best response to weak signals.*

It should be mentioned here, that the resistance of the valve from plate to filament is very high. Hence, the higher the potential produced by a given group of incoming oscillations the stronger the response obtained. Therefore, the secondary winding of the receiving tuner should be designed to give the maximum possible voltage for a given group of incoming oscillations. This requirement is met by a secondary inductance which requires a very small shunt condenser for resonance with the incoming signal. In general, the capacity of *C-1*, Figure 20,

should not exceed .0001 microfarads when tuning for the ordinary commercial wave length.

The valve of Figure 20 may be adjusted to the incoming radio signals as follows: The temperature of the filament F may be definitely fixed by means of a small ammeter, followed by adjustment of the potentiometer $P-1$ until the maximum strength of signals is obtained. In event that an ammeter is not provided, the operator must try various degrees of incandescence with simultaneous adjustment of the potentiometer $P-1$ until maximum signals are obtained in the receiving telephone.

(a) **Fleming Valve Circuits in Simple Form.** The Fleming valve may be employed as an oscillation detector without the use of an auxiliary E. M. F. Very good results are often so obtained. The circuit is shown in Figure 20a. Filament F is incandesced by battery $B-1$. One

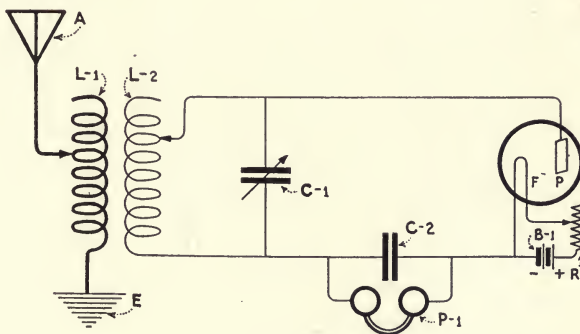

Figure 20a

Simple circuit for the two-electrode vacuum tube as an oscillation detector in radio telegraphy.

terminal of the secondary winding $L-2$ is attached to the plate P and the other to the negative side of the filament F . The action of the valve is as follows: When an oscillating E. M. F. is impressed upon the plate and filament, the plate P is charged alternately to a positive and negative potential. When plate P is charged to a positive potential electrons are drawn over from the filament, which is equivalent to saying that a semi-cycle flows from P to F . When P is charged negatively, no electrons are drawn over to the plate and consequently no current passes the valve. The condenser $C-2$, therefore, receives a uni-directional charge over the duration of a wave train and at the termination thereof discharges through telephone $P-1$. For best results the telephone should have a resistance of several thousand ohms.

(b) **Other Circuits for the Vacuum Valve.** In the circuit shown in Figure 20b, two batteries are employed with the two-electrode valve. The battery *B-1*, as usual, renders incandescent the filament, and the battery *B-2* supplies the local telephone current. It is to be noted that the terminals of the telephone circuit are attached to the plate *P*, and the negative side of the filament *F*. In practice, the operator carefully regulates the incandescence of the filament *F*, and adjusts the potential of the battery *B-2* until maximum response is secured in the head telephones.

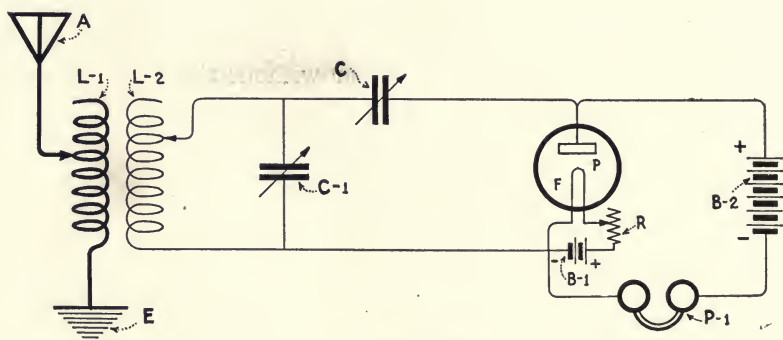

Figure 20b
Modified circuit for the Fleming valve.

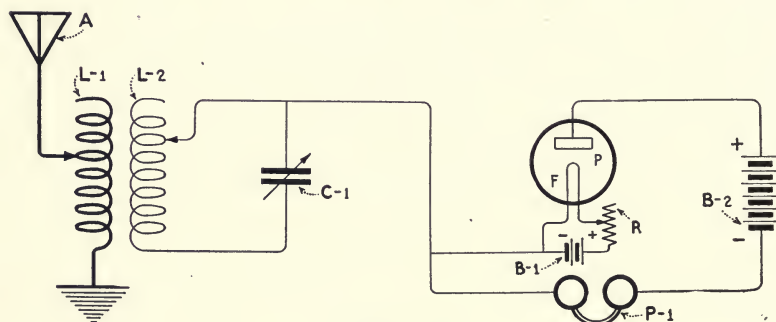

Figure 20c
Unipolar connection for the two-electrode valve.

The circuit shown in Figure 20c is somewhat similar to Figure 20b, with the exception that the negative side of the filament *F* is connected to one terminal of the secondary circuit. Additional uni-polar connections for the vacuum tube will be shown in Part VI. The adjustment of the apparatus in Figure 20c is similar to that in Figure 20b. The open and closed circuits of the receiving tuner are carefully tuned to the incoming signal, and the incandescence of the filament *F* and the

potential of the battery *B-2* carefully regulated until maximum response is secured.

The Fleming valve connected as in Figures 20 to 20c, constitutes a sensitive and very stable oscillation detector in radio telegraphy and has been much used in ship and shore stations.

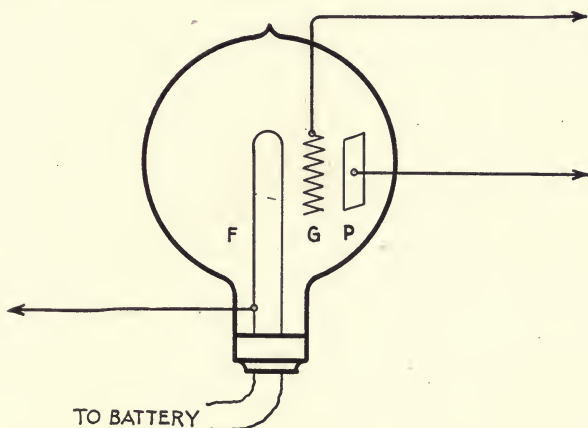

Figure 21

The fundamental construction of the three-electrode vacuum tube often called the electron relay.

16. THE THREE-ELECTRODE VALVE.—A wider range of circuits, and a greater ease of control of the vacuum valve as a detector in radio is secured by interposing what is termed a grid element between the filament and plate. The grid element valve as a detector in wireless telegraphy is credited to Dr. Lee DeForest. A valve so constructed is shown in Figure 21. *F* is usually a *tantalum or tungsten filament*; *G*, the *grid of tungsten, nickel or copper*; and *P*, a *nickel or aluminum plate*. The grid, filament, and plate may assume different shapes than herein shown, and may differ in material and construction, but the metals just mentioned are used in some types of valves. In one well-known type of valve, the filament, grid, and plate are made of tungsten.

The immediate effect of inserting the grid element can only be understood by clearly comprehending the conditions which would exist in its absence. Assuming the grid to be removed, the filament heated, and the plate battery connected, it is clear that an electrostatic field is maintained between the plate and filament, and that every point in this space will have some potential between that of the plate and that of the filament. It is this electrostatic field which causes the passage of electrons from the filament to the plate.

When the grid is inserted into the space between the plate and filament, we should naturally expect the grid to have the potential which the electrostatic field has at this point. This, however, is not the case, for the grid captures electrons and thus has its potential lowered. It may therefore finally become either positive or negative to the filament, but it will always be negative as compared with the potential which the space it occupies would have if it were removed. This has been experimentally proven by Armstrong.

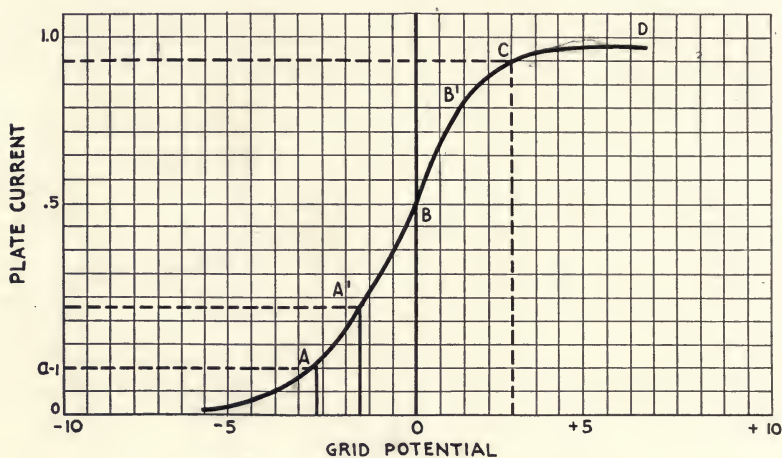

Figure 22

Grid—potential plate—current characteristic curve of the three-electrode vacuum tube.

This lowered potential of the grid *obstructs the flow of electrons* so that less escape to the plate. As in the two-electrode valve (in order to withdraw electrons from the filament), the positive pole of a battery *B-2* is connected to the plate, but if the grid element is charged sufficiently negatively by an external E.M.F., *the electron current will be completely cut off*. Normal flow of current (from plate to filament) can only be secured by charging the grid to a lower negative or to a positive potential. The student may now obtain a hint how the variation of the grid potential affects the strength of current in the plate circuit. For example, the amount of current flowing from *P* to *F'* may be varied by simply changing the potential of the grid element *G*. That is, the grid may be employed to open and close the plate circuit or to change its resistance.

Now, as already mentioned, the potential of the grid may be several volts *negative* to the negative side of the filament, or it may be the

same as the negative side of the filament, or it may be positive with respect to the field in the plane of the grid which would exist if the grid were removed from the bulb;* but it will always be negative with respect to the potential of the field in the plane of the grid which would exist if the grid were removed from the bulb.

Just how variation of the grid potential by an external E.M.F. effects the flow of the plate current will be readily understood by the plot of a characteristic curve of the three-electrode tube. We have already shown, in Figure 16, a characteristic curve of the two-electrode valve.

(a) **Characteristic Curve of Three-Electrode Valve.** Since there are three elements in this form of valve it is evident that several different groups of characteristic curves may be taken. Thus there is a plate-voltage to plate-current group of curves dependent on temperature of the filament, and a grid-voltage to grid-current group dependent on the temperature of the filament, and a grid-voltage to plate-current group dependent upon the filament temperature and plate voltage. These are all related in important but complex ways and, as in the case of the two-element bulb, the operation is by no means completely understood. We shall consider here only the grid voltage-plate current curve upon which the most commonly accepted explanation of the tubes' operation are usually based.

In the *curve for the three-electrode valve* shown in Figure 22, the horizontal axis indicates the *potential of the grid* in respect to the filament, and the vertical axis, the *plate current* in milliamperes. The difference between the curve of Figure 22 and that of Figure 16, is that the latter shows the volt-ampere relation in the *plate circuit* of the two-electrode valve, whereas Figure 22 gives the *values of the plate current* under different values of *positive and negative* grid potential.

The connections for the apparatus by which the data for this curve were obtained appear in Figure 23. Here *P-1* is a potentiometer; *B-2*, the battery for the plate circuit, 45 to 200 volts, and *A*, a milliammeter. The filament current is regulated by the 10-ohm rheostat *R*. The grid may be charged either positively or negatively by sliding the potentiometer contact *P-3* towards *B* or *A*.

The data for Figure 22, was secured by holding the voltage of the battery *B-2* at some constant value while changing the potential of the

*See *Proceedings of the Institute of Radio Engineers*, Sept., 1915, Vol. 3, No. 3,

grid to a positive or negative value. It will be observed that the plate current with this particular valve is maximum when the grid is charged to about three volts positive potential. With the grid at approximately five volts negative potential, the current in the plate circuit is nearly zero. On the straight part of the curve A^1 to B^1 the plate current is directly proportional to the grid potential. Hence, *if an alternating E.M.F. of not too great value is impressed upon the grid and filament, the plate current will rise and fall uniformly.*

The curve of Figure 22 will repay careful study, for it is upon the operating characteristics therein shown, that the at present accepted explanations of the fundamental actions of the three-electrode vacuum valve as a detector and amplifier in radio-telegraphy are based.

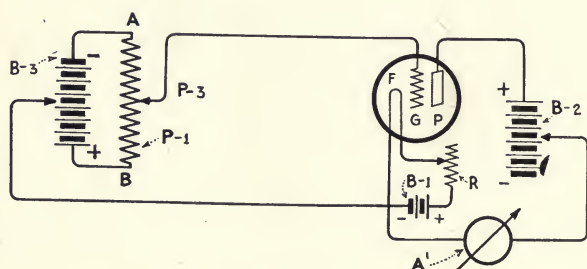

Figure 23

Connections of the apparatus for obtaining the characteristic curve of the three-electrode tube.

By way of illustration it is clear, from Figure 22, that if the grid has been adjusted to a fairly high negative potential, for example, that indicated by point A , a few volts decrease (of the grid potential) permits a *large increase of current* in the plate circuit, as may be seen by following the dotted line from A^1 to the vertical axis. On the other hand, if the grid potential is increased negatively by the same amount, the *plate current decreases by a relatively smaller amount*. Hence, if the valve is employed as a *detector of radio frequency oscillations* and the grid potential is adjusted to point A on the curve, Figure 22, the rise and fall of the grid potential occasioned by the incoming oscillations produces a current of similar frequency in the plate circuit, the *amplitudes of the increase exceeding those of the decrease*. Hence, what amounts, in so far as the telephone is concerned, to a uni-directional current charges the telephone condenser which discharges through the telephone once for each group of incoming oscillations. It is also clear that if the valve is worked at the upper bend of the curve, Figure 22, the foregoing actions

will be reversed, *i.e.*, a group of incoming oscillations will cause the telephone current to decrease rather than increase.

The curve will be discussed again in paragraph 17.

(b) **Valve Terminology.** In order to prevent confusion from this point on, we shall refer to the circuit containing the plate, the local battery, and the head telephone as the "*plate circuit*" and to the secondary circuit including the secondary tuning coils, condensers, potentiometer, battery, and grid as the "*grid circuit*."

Thus, in Figure 24, the *grid circuit* includes *L-2*, *C-1*, *P-1*, *B-3*, *C-2*, *G*, to the negative side of *F*. The *plate circuit* embraces *P*, *negative side of F*, *B-2*, *P-2*, and the vacuous space from *P* to *F*. It is also customary to call the grid circuit the *input* circuit, and the plate circuit the *output* circuit.*

We shall frequently refer to the current of battery *B-2* as the "*plate current*" and the necessary changes of grid potential will be effected by the "*grid battery*" *B-3*.

We shall also speak of the *audio frequency and radio frequency "component"* of the plate current. These terms will be explained in detail further on.

17. THE THREE-ELECTRODE VALVE AS AN ELECTRON RELAY AND RECTIFIER.—

(a) **The Valve as an Electron Relay (without Grid Condenser).** As already mentioned, the only fundamental operating characteristic of the vacuum valve as an oscillation detector of which we shall make use is the graph of Figure 22. We shall show more in detail that the three-electrode valve may be employed as a *relay* or as a *combined rectifier and amplifier*.

A complete circuit for taking advantage of the non-uniform *characteristic* of the three-element tube is shown in Figure 24, where the plate *P* as usual is charged positively by the battery *B-2* in series with which is the telephone *P-2*. Filament *F* is incandesced by battery *B-1* and the strength of the current regulated by rheostat *R*.

The potential of the grid to filament is definitely fixed by battery *B-3* shunted by potentiometer *P-1*. Condenser *C-2* provides a path for the radio frequency currents about the potentiometer *P-1*. The *primary winding* of the usual receiving tuner is indicated at *L-1* and the secondary winding at *L-2*.

*The filament circuit including the lighting battery and the rheostat is often termed the "A" circuit, and the plate circuit the "B" circuit.

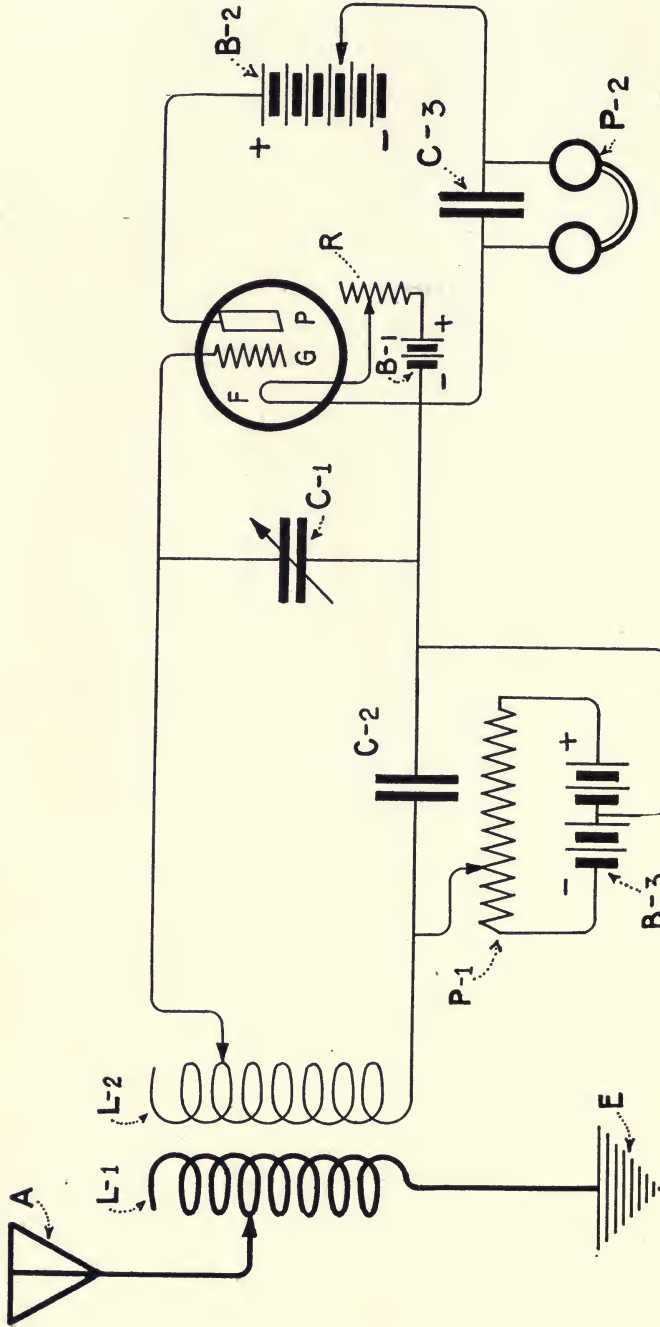

Figure 24

Showing one method of connection for the three-electrode valve as an oscillation detector in wireless telegraphy. Connected in this manner the valve is termed an asymmetrical relay.

(b) **Functioning of the Valve as Explained from the Characteristic Curve.** The manner in which the valve functions in Figure 24 has been partially explained in a preceding paragraph. Reference should again be made to Figure 22. Assume, for example, the potential of the grid in respect to the filament is that corresponding to point *B*, that is the grid and filament have the same potential; then a negative charge applied to the grid produces a *decrease* in the plate current and a positive charge imparted to the grid produces an *increase* in the plate current.

Hence, if an alternating E.M.F. such as a group of incoming radio frequency oscillations is impressed upon the filament and the grid, the plate current will rise and fall at the frequency of the impressed E.M.F., *i.e.*, the *incoming radio frequency current will be repeated in the plate circuit*, but often, with increased amplitude owing to the radio frequency amplifying action of the valve.

This current, however, will not be heard in the receiving telephone because its frequency is above audition and the positive and negative halves are of equal amplitude. But, as the curve of Figure 22 clearly indicates, if the potential of the grid is adjusted by a potentiometer to point *A*, a small decrease in the grid potential, (*i.e.*, a change toward zero) causes a *comparatively large increase* of the plate current; on the other hand, an increase of the grid potential (in a negative sense) causes a relatively small decrease of the plate current. Hence, if the grid and filament are connected to the secondary terminals of a receiving tuner, what amounts to a *rectified current* will flow in the plate or output circuit, that is, the average increase in current occasioned by the positive halves of the incoming oscillations exceeds the average decrease in current due to the negative halves of the incoming oscillations. This current charges the telephone condenser *C-3*, Figure 24, which discharges through the telephone probably in one direction. As already explained in connection with the two-electrode tube, if the grid potential is adjusted to the upper bend of the curve, the foregoing action is reversed. The effect of a group of incoming oscillations then is to decrease the plate current.

Since each group of incoming oscillations causes a large increase of current through the head of the telephone, the diaphragm will produce one click for each spark discharge at the transmitter.

It is apparent from the characteristic curve that the repeated plate current may have uniform increase or decrease, or it may assume the nature of a rectified current depending upon the point on the characteristic curve at which the valve is worked. Thus, near the upper bend *C*, and the lower bend *A*, a rectified current will flow in the plate

circuit, but along the straight portion of the curve *B*, equal increase and decrease of the plate current will be obtained. In the latter condition, the valve is properly adjusted for *amplification by a second tube, i.e.,* cascade amplification at radio frequencies.

In the diagram of Figure 24, the grid battery is connected in the grid circuit to take advantage of the non-uniform properties of the

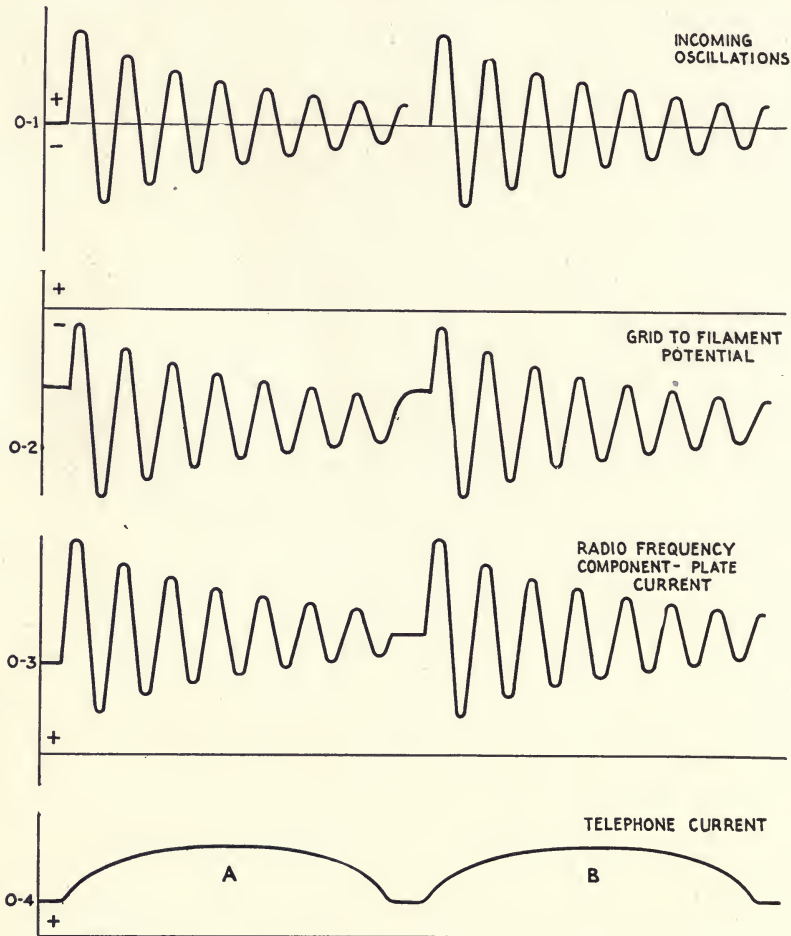

Figure 25

Curves showing how the vacuum valve used as an assymetrical relay produces audible response in the receiving telephone.

tube, but it should be understood that the tube will function in the same way without the grid battery; that is, if a good sample of a valve is used, *by careful adjustment of the filament temperature and*

the plate current, the operator can obtain the best operating characteristic for a given condition of service. In other words, he thus locates the point on the curve which will give the loudest response in the head telephone without employing a grid battery.

(c) **Relaying Action.** We have shown that, owing to the relaying action of the valve, a current of any wave form impressed upon the grid circuit may be repeated with amplification in the plate circuit. This relaying effect is obtained by reason of the phenomenon shown by the characteristic curve, *i.e.*, a fractional amount of energy impressed upon the grid circuit causes a larger variation of current in the plate circuit. Owing to the extreme mobility of electrons under the influence

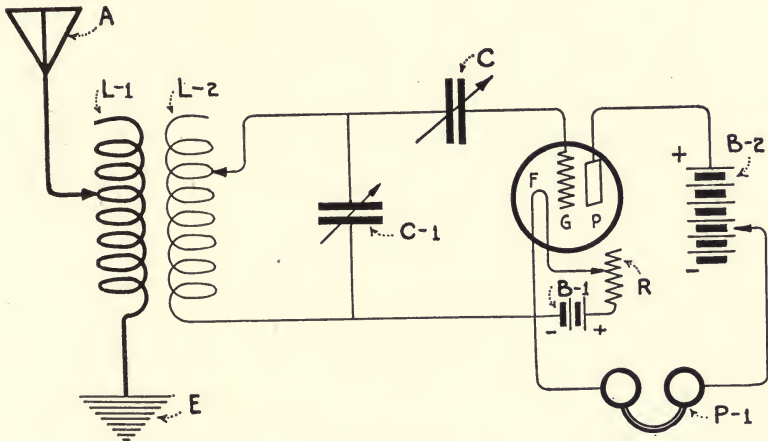

Figure 26

The circuit for the use of the valve as a combined rectifier and amplifier. Incoming oscillations are rectified and stored up in the grid condenser, the charge and discharge of which varies the telephone current at an audio frequency.

of positive and negative electrostatic fields, this relaying action may be secured both at *audio* and at *radio frequencies*.

The result is analogous to that of an ordinary land line telegraph relay in which feeble line currents energize a magnet winding of a relatively great number of ampere turns. In front of the magnet poles is mounted a light armature carrying a platinum point which, in turn, makes contact with a stationary contact closing the circuit of a more powerful battery including in its circuit a telegraph sounder; greater volume of sound is secured from the sounder because of the greater strength of the local battery current compared to the current which flows through the windings of the relay.

Diagrammatically, the actions of the valve as a *relay* for reception of signals in wireless telegraphy is shown in Figure 25. *O-1* represents the incoming oscillations; *O-2*, the potential of the grid to filament; *O-3*, the radio frequency fluctuations of the plate current, and *O-4*, the approximate average telephone current. It is readily seen in graph *O-4* that the effect of a single group of incoming oscillations is to increase the *telephone current* at an audio frequency. This is the action in the region of the lower bend of the curve. At the upper bend the action is reversed.

If the grid is maintained at a *negative potential* by the grid battery, it prevents the flow of a conduction current between the grid and filament. Hence, the grid circuit absorbs no energy from the incoming oscillations. This reduces the damping of the secondary circuit.

(d) **Use of the Three-Electrode Valve with Grid Condenser.** The circuit shown in Figure 26, differs from that of Figure 22, in that it employs the so-called *grid condenser*, *C*, connected between the grid and the upper terminal of the secondary coil of the receiving tuner. The function of the grid condenser is to store up the currents which are rectified by the valve action between the grid and filament. As will be explained further on, the *charge and discharge of this condenser* during the reception of damped oscillations in radio telegraphy *decreases and increases the plate current at an audio frequency*.

The action is somewhat as follows: When the incoming oscillations tend to charge the grid negatively no current flows from the grid to the filament, but when the grid is charged positively current passes from the grid to filament, and the grid condenser therefore receives a uni-directional charge over the duration of a wave train. Therefore a charge of increasing strength piles up in the grid condenser *C*, which is *negative* on the grid side. This, as is clear from the fundamental curve of Figure 22, obstructs more and more the passage of electrons from the filament to the plate, causing a decrease in the plate current. At the termination of a group of incoming oscillations, the charge in the grid condenser leaks off either through the valve itself, or through a special leak resistance of several thousand ohms shunting the grid condenser. *The grid then returns to normal potential and likewise the plate current*. It is evident that each spark at the transmitter eventually reduces the telephone current at the receiver. In other words, the telephone current varies as the spark frequency of the transmitter.

During the time that the incoming oscillations undergo rectification, the potential of the *grid fluctuates at a radio frequency* and, just as in the case of Figure 24, the *plate current rises and falls at a radio fre-*

quency, but this current is *not* heard in the head telephone. Although this repeated radio frequency current is not heard in the head telephone it is put to account in the *regenerative* and *amplification circuits* described further on.

Reviewing the foregoing, it is seen that two results are obtained simultaneously in the plate circuit. During the time that the rectified oscillations* are building up a charge in the grid condenser, the current in the plate circuit decreases, but when the charge leaks out the

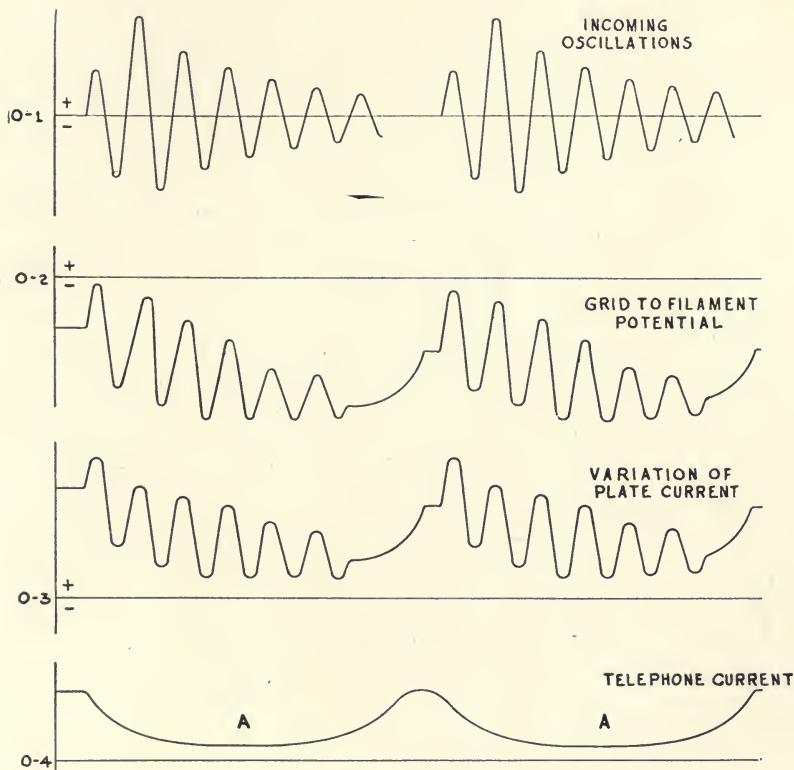

Figure 27

Graphs showing the operating phenomena of the three-electrode tube as an oscillation detector, with a series or grid condenser.

*Rectification occurs in the vacuum tube in the following way: the electronic emission of the filament is in the direction of the grid, and in terms of the electronic theory, negative electricity can pass from the filament to the grid but not in the opposite direction, which is the same as saying in terms of the old theory, that current can pass from the grid to the filament but not in the opposite direction. When a group of radio frequency oscillations are impressed upon the grid circuit each succeeding half of the incoming wave train tends to increase the charge in the grid condenser. The wave train is thus rectified.

condenser, the plate current returns to normal value. This reduction follows the spark at the transmitter. Meanwhile the incoming oscillations are repeated in the telephone circuit.

Diagrammatically, the actions of a three-electrode tube with a *grid* condenser can be shown as in Figure 27, where graph *O-1* shows *two groups of incoming oscillations*; graph *O-2*, *the potential of the grid in respect to the filament*; graph *O-3*, *the corresponding reduction of the plate current and the superposed or repeated radio frequency current*; and graph *O-4*, *the approximate average telephone current*.

(e) **Radio- and Audio-Frequency Component of the Plate Current.** The student should give attention to the curve *O-3* of Figure 27. Here the successive variations of the plate current in *O-3* are those of the repeated radio frequency current and they are termed the *radio frequency component* of the plate current. The large depression *A* in the oscillogram *O-4*, represents the reduction of the plate current occasioned by the charge which accumulates in the grid condenser during a group of incoming oscillations. This variation is termed the *audio frequency component* of the plate current.

In order to prevent an extraordinary potential from piling up upon the condenser *C*, a battery and potentiometer are often connected around the grid condenser to control definitely the charge accumulating in it. For instance, if the grid became charged to an excessive negative potential, the plate current would be reduced to zero and the valve rendered inoperative.

The student will now observe that the apparatus in the diagrams, Figures 24 and 26, functions in a manner similar to the diagram of Figure 20.

With the connections of the diagram of Figure 24, it is desirable that the potential of the grid be carefully regulated by the grid battery in order that best advantage may be taken of the non-uniform conducting properties of the valve, for at the points on the characteristic curves where the plate current increases and decreases by unequal amounts, the maximum sound will be obtained from the head telephone.

(f) **Summary of the Phenomena of the Characteristic Curve.** In addition to the deductions which may be drawn from the characteristic curve of Figure 22, some of which have been mentioned in preceding paragraphs and here repeated, additional phenomena are presented.

As already stated, if the grid potential corresponds to that of point *A* on the lower bend of the curve, the amplitude of the positive halves of the plate current occasioned by the incoming oscillations exceeds the

amplitude of the negative halves. But if, on the other hand, the grid potential is adjusted to the upper bend or point *C*, the former condition will be reversed, that is, the amplitude of the negative halves of the repeated radio frequency oscillations in the plate circuit will exceed the amplitude of positive halves which is just opposite to that in the preceding case. At any point along the straight slope of the curve, such as from A^1 to B^1 , approximately equal increases and decreases of the plate current will be obtained provided the alternating E.M.F. impressed upon the grid is not too great.

Again, if the valve is operated at point *A* and the voltage impressed upon the grid by an oscillating E.M.F. of radio frequency is but a small fraction of a volt, substantially equal increases and decreases of the plate current will be secured, but no response will be obtained in the head telephone for as already explained, the telephone will not respond to radio frequencies.

If the valve is to be used as an amplifier, as will be described further on, and it is desired that the plate current increase and decrease

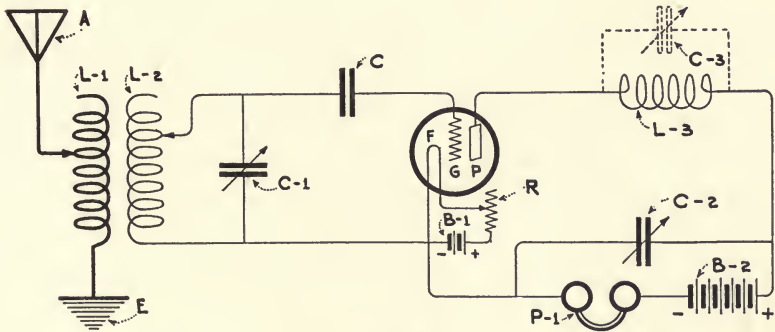

Figure 28

The three-electrode vacuum valve as an oscillation detector with a tuned plate circuit.

by equal amounts, the valve may be worked at the upper or lower bends (at point *A* or point *C*), for small impressed E.M.F.'s. But, as stated before, if the voltage impressed upon the grid is rather high, then a distortionless current will be obtained in the plate circuit for any given E.M.F. impressed upon the grid circuit, *only* along the slope of the curve A^1 to B^1 . This however is not true in all cases.

18. THE TUNED PLATE CIRCUIT.—Further amplification of incoming radio signals can be obtained by tuning the plate circuit of the vacuum valve. Armstrong's method is shown in Figure 28, but since

this is essentially a *regenerative* system, it will be considered more in detail in connection with other tuned plate circuits in Part IV.

In addition to the apparatus of previous diagrams, this circuit includes a plate circuit inductance $L-3$ and a condenser, $C-3$. The coil $L-3$, in conjunction with the electrostatic capacity of the valve (between F and P) constitutes an oscillation circuit of variable frequency. The condenser $C-2$ acts as a by-pass for the radio frequency component of the plate current around the head telephone $P-1$ and the battery $B-2$. Condenser $C-2$ may be of fixed capacity.

In brief, as the incoming radio frequency oscillations are repeated into the plate circuit, the counter E.M.F. of coil $L-3$ either assists or opposes the plate circuit battery according to whether the latter decreases or increases. The effect of this counter E.M.F. is to alternately decrease and increase the potential difference between F and P , and since the space between F and P constitutes a condenser of small capacity, the charge accumulated therein is varied in accordance.

As will be explained in Part IV, the internal or self-capacity of the valve acts as a coupling to transfer energy from the plate circuit to the grid circuit, the energy for which is supplied by the reactance voltage of the coil $L-3$. Marked amplifications are thus secured.

PART III

CASCADE AMPLIFICATION BY THE VACUUM VALVE

19. IN GENERAL.—In the preceding chapter we have described two general methods by which damped oscillations in radio telegraphy can be detected by the three-electrode valve.

In the first method :

- (1) The potential of the grid in respect to the filament may be maintained so that a positive charge impressed upon the grid will cause a large increase in the plate current, and a negative charge will cause a small decrease of the plate current. Or at other points on the characteristic curve, the reverse effect may be obtained. In either case, the effect over the duration of a wave train is to impulse the telephone receiver once for each group of incoming oscillations. In other words, what amounts to a rectified current flows in the plate circuit.

In the second method :

- (2) The plate current is made to vary at an audio frequency by placing a condenser in series with the grid. The valve action between the grid and filament rectifies the incoming groups of radio frequency oscillations, and the grid condenser receives a unidirectional charge over the duration of a wave train. As the charge builds up, the plate current decreases, but upon the termination of a group of oscillations the charge leaks out the grid condenser and the plate current returns to normal value.

The sensitiveness of the valve in the second case is determined by its construction, *i.e.*, the size of the grid, and the spacing between it and the filament or the plate. If the construction is correct, the proper operating characteristic is found by adjusting the filament temperature and the voltage of the plate battery until maximum response is secured. Reference is made to the diagram of Figure. 26.

Usually with this circuit, when the filament is rendered incandescent the potential of the grid will be somewhere near point *B*, Figure 22.

In other words, since in the diagram of Figure 26 the potential of the grid in respect to the filament cannot be definitely fixed by a grid battery, the operator must select some combination of filament temperature and plate voltage that will give the correct operating characteristic, for maximum response in the head telephone. This adjustment generally is not difficult to find with a properly constructed valve, but in event that the valve is improperly constructed it will not in this circuit act efficiently as a detector of incoming oscillations.

In addition to (1) and (2) we have established another fact:

- (3) By tuning the plate circuit to the radio frequency oscillations further amplification of the incoming signal is secured.

In addition to (1), (2) and (3) we must remember the fundamental actions of the valve connected as in Figure 24, *i.e.*,

- (4) The incoming radio frequency currents are repeated in the plate circuit, but with distortion, so that a rectified current impulses the telephone diaphragm.

Keeping all these facts before us it is obvious that the valve may be connected in a number of ways for further amplification of incoming radio signals (damped oscillations). There are two general methods by which amplification can be secured:

- (5) In the reception of damped oscillations either the resultant radio or audio frequency component of the plate current of the first valve can be impressed upon the filament and grid or input circuit of a second valve and again amplified.
- (6) Either the resulting radio or audio frequency currents or both simultaneously can be impressed upon the grid of the same valve and thus re-enforced, *i. e.*, regenerative amplification secured.

We shall show in Part VI.

- (7) That the valve can be used to generate undamped oscillations for the production of the heterodyne effect, *i. e.*, beat reception;
- (8) and that the combined operations of generation, amplification and beat reception can be performed in a single vacuum tube simultaneously.

We first shall consider the circuits and functioning of the *cascade radio-frequency amplifier*.

20. CASCADE RADIO FREQUENCY AMPLIFIER.—In a circuit where the radio or audio frequency component of the plate current of one valve is impressed upon the grid and filament of the second valve, that is where the *output circuit* of the first valve is coupled to the *input circuit* of the second valve and so on, the valves are said to operate in cascade. In practice, as many as six valves have been thus

used, but three usually suffice for practical operating conditions, and little gain usually results from employing more.

The complete circuits of a *cascade radio frequency amplifying system* are shown in Figure 29 where a coupling transformer M with the windings $P-4$ and S serves to impress the radio frequency component of the plate circuit of the first valve upon the grid and filament of the second valve, that is the *output circuit of the first tube is coupled to the input circuit of the next tube*.

The antenna circuit of this diagram embraces the antenna loading inductance L , the primary winding of the receiving transformer $L-1$, and the short wave variable condenser $C-8$. The secondary or grid circuit comprises the secondary coil $L-2$, the secondary loading inductance $L-3$, the shunt secondary condenser $C-1$, and the fixed condenser C shunting potentiometer $P-1$ which has resistance of about 400 or 500 ohms.

$B-3$ is a battery from three to twenty volts. $B-1$ is the usual filament battery, and $B-2$, the high voltage battery of the plate circuit of the first valve. The plate circuit also includes the radio frequency circuit $P-4$, $C-4$; $P-4$ being the primary of a radio frequency transformer which acts inductively upon winding S . $L-4$ is the loading inductance for the grid circuit of the second valve and S is the secondary coil. $C-5$ is the shunt secondary condenser. The condenser $C-6$ performs the function of C in the first valve. The plate circuit of the second valve comprises the battery $B-5$, the head telephone $P-3$, and the shunt condenser $C-7$.

The operation of this system is based upon the phenomenon shown by the characteristic curve in Figure 22 which, for convenience, is reproduced in Figure 30.

Assume, for example, that the potentiometer $P-1$ of valve No 1 is adjusted so that the grid potential with no signals in the receiving system is approximately at the point A on the lower bend of the curve. Suppose that the incoming signals are relatively weak, *i.e.*, of just sufficient strength to increase and decrease the grid potential a small fraction of a volt. Then as the curve shows, an equal increase and decrease of the plate current is secured. This variation takes place at a *radio frequency*, and consequently no response would be secured from the telephone diaphragm if it were connected in the plate circuit of this valve.

On the other hand, if the *signalling E.M.F. is rather strong*, then it will be seen from the shape of the lower bend of the curve that the positive half of the incoming cycle will produce a *relatively large increase* in the plate current and the negative half a *relatively small decrease*. Therefore, what amounts, in effect, to a *rectified current*

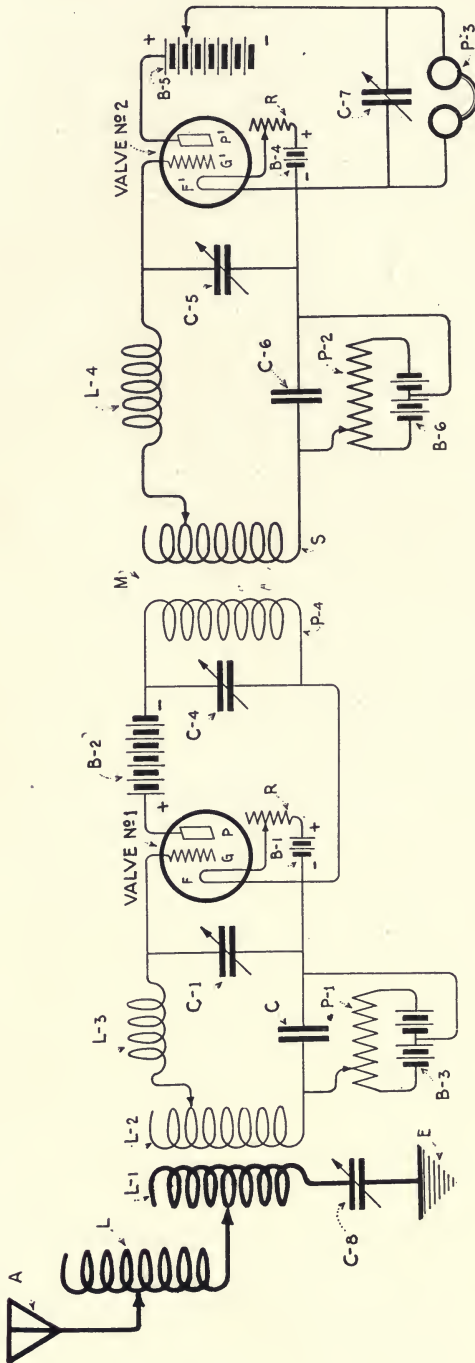

Figure 29

Cascade connection of vacuum tubes for the amplification of radio frequencies. The output circuit of one tube and the input circuit of the next tube are coupled through radio frequency transformers.

would flow through the head telephone, *P-3* (if it were connected in the plate circuit of the first valve). But if the incoming signal is too weak to obtain an assymetrical relaying effect in the plate circuit of the first valve, response can only be obtained in the receiving telephone by amplifying the plate oscillations of the first valve through the *medium of the second valve*. Then if the second valve is adjusted to the proper operating characteristic, the amplified incoming oscillations impressed upon its grid and filament will cause a rectified current, that is, a current which increases to a greater degree than it decreases or vice versa, to charge the telephone condenser, *C-7*. The latter discharges into the head telephone *P-3* in one direction.

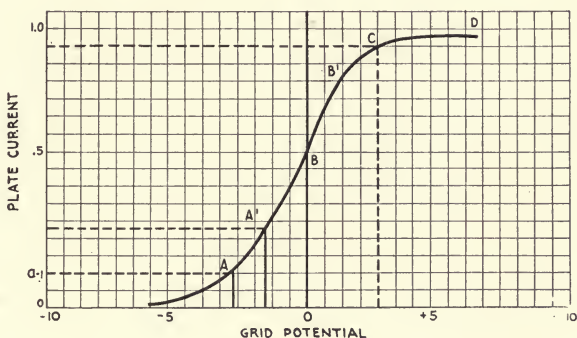

Figure 30

Grid-potential plate-current curve of the three-electrode oscillation valve.

(a) **Curves of the Cascade Amplifier.** Diagrammatically, the amplifying action of the cascade radio frequency system can be shown by the series of curves, Figure 31,—where the group *O-1* indicates the radio frequency variation of the continuous plate current in the first valve; the group *O-2*, the oscillating E.M.F. impressed upon the grid of the second valve, and the group *O-3*, the repeated plate current in valve No. 2. The average effect of the *uni-directional plate current* pulses as far as the head telephone diaphragm is concerned is indicated by the line *O-4*. This variation of the plate current takes place at an *audio frequency*, i.e., it follows the spark at the transmitter*.

In this system, the plate circuit of valve No. 1 may be *tuned* or *untuned*. It is essential, however, that the grid circuit of the second

*If the last or detecting tube is adjusted somewhat near the upper bend of the characteristic curve, the telephone current decreases for each group of incoming radio frequency oscillations.

valve be accurately adjusted to the radio frequency component of the plate current of the first valve. This is accomplished by the variable shunt condenser *C-5*.

The plate circuit of valve No. 1 may be tuned to resonance with its radio frequency component by means of the variable condenser *C-4*. If condenser *C-4* in shunt to the primary winding *P-4* gives that circuit

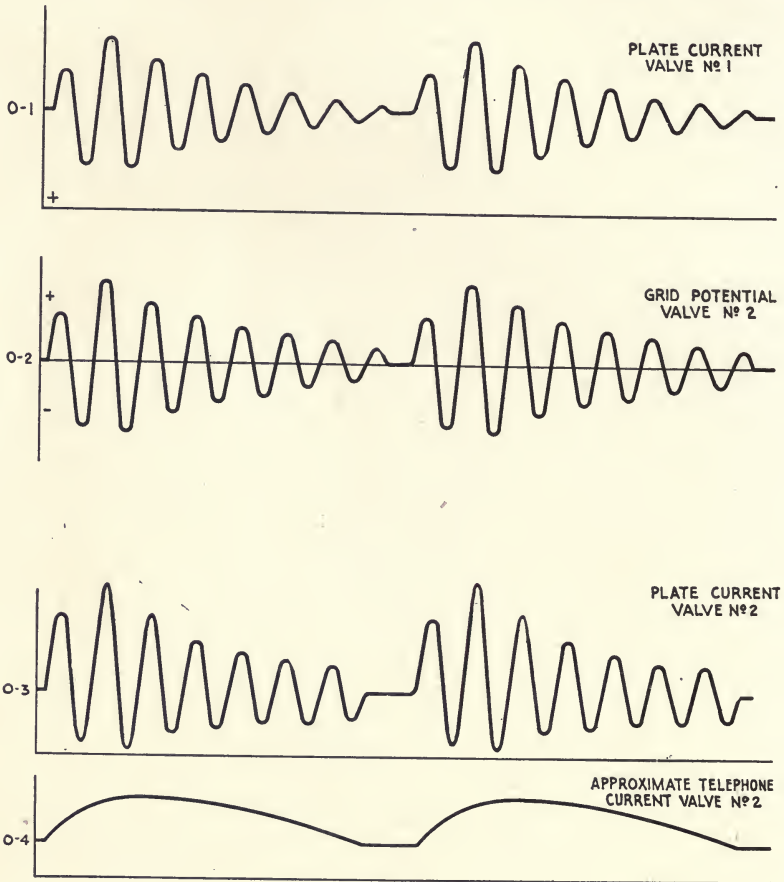

Figure 31

Graphs showing the functioning of the cascade radio frequency amplifier.

a frequency of oscillation equal to that of the radio frequency component of the continuous plate current, then a well defined resonance phenomenon takes place and the amplitude of the plate circuit oscillations is increased. Tuning of the plate circuit is more effective in practice, when the incoming oscillations (induced in the receiving antenna *A*) are comparatively weak.

In the operation of the apparatus shown in Figure 29, some energy is withdrawn from the circuits of the first valve by the second valve through the coupling M , and in consequence, as the coupling is altered re-adjustments of the various elements of the complete circuit ordinarily must follow.

In order to secure amplification from the apparatus of Figure 29, the potentiometer $P-1$ should be adjusted so that the grid potential will have some value along the straight part of the curve, say near the point B , Figure 30; but the grid potential of the second valve must be adjusted (by potentiometer $P-2$) to take full advantage of the *assymetrical conductivity* of the valve, *i.e.*, to point A , Figure 30. Then condenser $C-7$ will receive a uni-directional charge over the duration of each wave train and its discharge through the telephone $P-3$ will be practically aperiodic, that is, in one direction.

Instead of adjusting the potential of the grid of value No. 2, Figure 29, to take advantage of its *assymetrical properties*, we may insert a *grid condenser* such as shown at C in Figure 26. The circuit then functions identically as explained in connection with that diagram, that is, the incoming oscillations are rectified, and a charge accumulates in the grid condenser over the duration of a wave train. As the charge increases, the plate current of valve No. 2 gradually decreases. At the termination of a group of oscillations the charge leaks out the grid condenser either through the valve or through a special leak resistance (shunted about the grid condenser or connected from grid to filament), whereupon the plate current (battery $B-5$) returns to normal strength. This action, as has already been explained, is repeated for each spark discharge at the transmitter.

21. CASCADE AUDIO FREQUENCY AMPLIFIER.—We have pointed out in paragraph 17 (and shown the connections therefor in the diagram of Figure 26) how the successive groups of incoming (damped) oscillations may be rectified and stored up in a grid condenser, and how, during the piling up of this charge the plate current decreases. At the termination of the incoming wave train the charge leaks out of the condenser and the plate current returns to normal value. This variation of the continuous current in the plate circuit is termed the *audio frequency component* of the plate current.

The audio frequency component may be amplified through the medium of a second valve. One method is shown in the diagram of Figure 32, wherein the *plate circuit* of the first valve and the *grid circuit* of the second valve are coupled inductively through the iron core transformer M . The primary and secondary coils of M consist

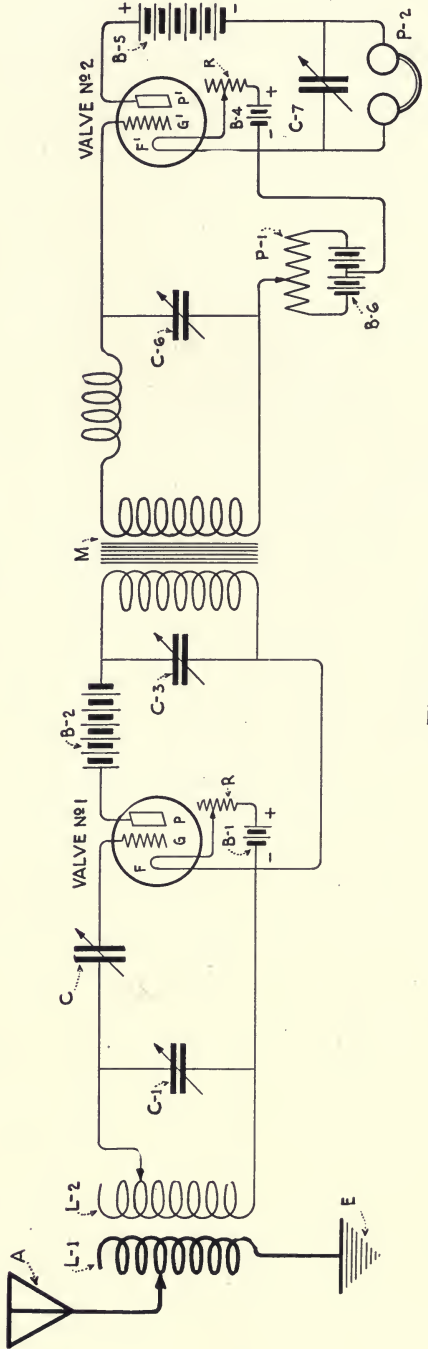

Figure 32

The circuits of a cascade audio frequency amplifier. An audio frequency transformer is connected between the output circuit of one tube and the input circuit of the next tube.

of several thousand ampere turns of relatively fine wire such as No. 32 or No. 34 *B* and *S* wound over a common iron core, the inductance of either winding amounting to a henry* or more. Condensers *C*-3 and *C*-6 serve to tune the primary and secondary circuits of *M* to the desired audio frequency of 300 to 1,000 cycles, although they may be omitted with good results.

In order that valve No. 2 may be adjusted for maximum amplification, battery *B*-6 and potentiometer *P*-1 are included in the grid circuit.

The apparatus of Figure 32 functions as follows: The successive groups of incoming oscillations are converted to audio frequency variations of the plate current (*B*-2) through the charge and discharge of the grid condenser. This component of the plate current is impressed upon the grid circuit of the second valve through the coupling *M*. Through the medium of the grid potentiometer *P*-1 the second tube is adjusted for the best amplification of the impressed audio frequency current. The condenser *C* of valve No. 1 may be dispensed with and the valve adjusted for assymetrical relaying by providing a special grid battery, as with valve No. 2.

In practice, a simpler circuit† for audio frequency amplification than that shown in Figure 32 has been employed. Generally, three valves are connected in cascade, being coupled together through *simple iron core transformers* between the output and input circuits of successive valves. No attempt is made to tune these transformers to the desired frequency.

Although the apparatus shown in Figure 32 is designed primarily for the amplification of audio frequencies, some of the radio frequency energy of the plate circuit of the first valve is impressed upon the grid circuit of the second valve through the electrostatic capacity of the windings of *M*, and detected in the last valve. It may then be amplified by a regenerative circuit or a radio frequency amplification circuit.

A single coil, *i.e.*, an auto-transformer, may be substituted for the transformer *M*.

*Some transformers of this type have primary inductance of 15 henries and secondary inductance of approximately 90 henries.

†In one type of commercial cascade amplifier, an oddly constructed transformer is employed between the plate and the grid circuit of the successive valves. The primary winding of the audio frequency transformer is inserted in series with the plate circuit in the usual manner, but the secondary winding is left open-circuited, that is to say, one terminal is connected to the grid of the valve but the other terminal remains free. By this manner of coupling it is possible to employ a single battery to light the filaments of all valves. Armstrong mentions that leaving the secondary circuit open permits the grid to assume a potential suitable to amplification.

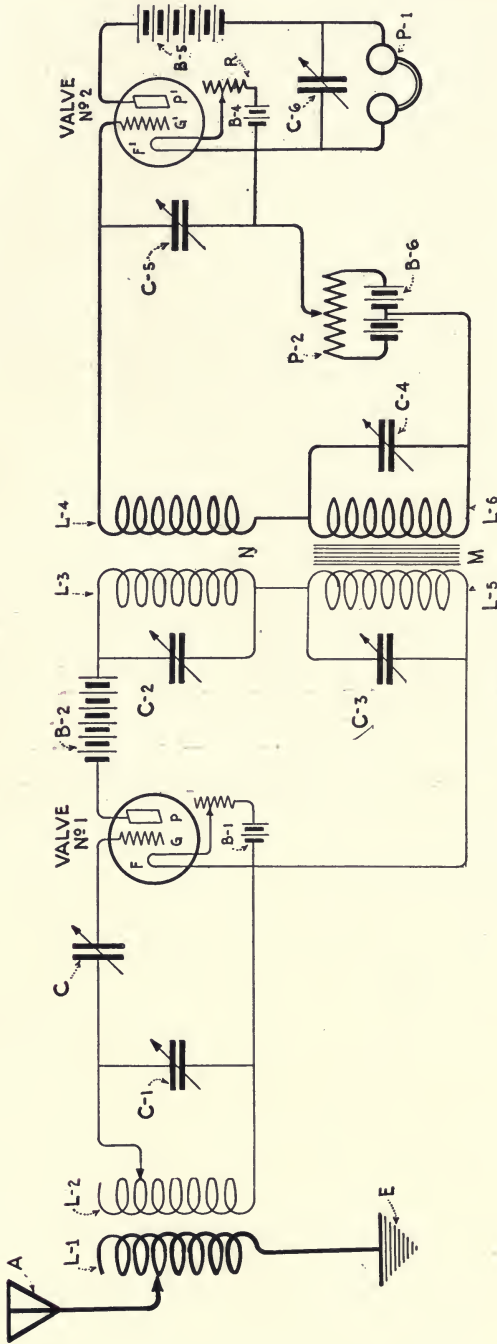

Figure 33

Cascade connection of vacuum tubes for combined audio and radio frequency amplification. The plate or output circuit of the first valve is coupled to the grid or input circuit of the second valve through the radio frequency transformer L-3, L-4, and the audio frequency transformer L-5, L-6.

22. COMBINED RADIO AND AUDIO FREQUENCY CASCADE AMPLIFIER.—By means of the connections shown in Figure 33, the *radio* and *audio frequency* components of the *plate or output circuit of one valve* may be amplified *simultaneously* through a second valve.

In this system, the audio frequency component of the plate circuit is impressed upon the grid circuit of the second valve through transformer *M*. Condenser *C-3* serves as a by-pass for the radio frequency currents around the audio frequency inductance *L-5*. Condenser *C-2* serves to tune the plate circuit to the incoming oscillations (the radio frequency component of the plate current) and *C-5* tunes the grid circuit of the second valve to the same frequency, the radio frequency current of the plate circuit being impressed upon the grid circuit of the second valve through the coupling *L-3*, *L-4*. Condenser *C-4* acts to by-pass the radio frequency current in the grid circuit of the second valve around the audio frequency coil *L-6*. Potentiometer *P-2* shunting battery *B-6* enables the operator to obtain the best relaying characteristic of valve No. 2.

As usual, a grid condenser can be inserted in the circuit of valve No. 2, and the relaying action obtained without the potentiometer. The battery *B-6* is preferably shunted by a condenser of fixed capacity.

At first sight, the circuits shown in this chapter seem complicated in structure and difficult of adjustment, but it should be understood that if the tuner is designed for a given range of wave lengths, it is not necessary to re-adjust each element of the circuit to select a new wave length. For example, the apparatus could readily be designed so that the principal adjustments for resonance are obtained at the primary coil, the secondary condenser, the grid circuit condenser, and plate circuit condenser. A slight variation of the grid circuit potentiometer is necessary for the louder strength of signals.

PART IV

THE REGENERATIVE VACUUM VALVE AMPLIFIER

23. **IN GENERAL.**—The preceding chapter is devoted to amplification by cascade connection of a number of valves. This section will be devoted to the *regenerative system of amplification* whereby the strength of the incoming radio signals is increased within the same bulb. Experiments with such circuits were first reported by Captain Edwin H. Armstrong, whose researches have been fully described in the September 1915, issue of "Proceedings of the Institute of Radio Engineers."

24. **PRELIMINARY CONSIDERATIONS.**—We have already shown that the vacuum valve acts as a *repeater of radio frequency currents, i.e.*, if an oscillating voltage is applied to the grid and filament, the plate current will oscillate at the same frequency. Also through the use of a grid condenser during the reception of damped oscillations the plate current varies simultaneously at an *audio* and a *radio frequency*; or through the employment of a grid battery, we can adjust the grid potential so that the increase of the plate current for each incoming semi-cycle will exceed the decrease or vice versa and what in effect amounts to a rectified current flows in the plate circuit. Careful consideration of these fundamental actions will assist the student to understand the functioning of the regenerative receiver.

We shall disclose in this chapter circuits whereby either the audio or radio frequency component of the plate current can be impressed upon the grid of the same valve and thus reinforced. The circuits through which such amplifications are obtained are known as "*regenerative*" or "*repeater*" circuits. Abroad, they are termed "*re-action*" circuits.

25. THE PRINCIPLE OF REGENERATION.—We have already set forth how variation of the grid potential of the three electrode vacuum valve changes the strength of the plate current; and that a very slight change in the grid potential, if the proper bulb characteristic is secured, results in a relatively large change in the plate current.

The characteristic curve of the valve indicates that if by any means the grid potential is reinforced above and below the maximum value supplied by the incoming radio signal, a still greater change in the telephone current is bound to follow.

Since, during the reception of radio signals the plate current varies at the frequency of the incoming oscillations it will be seen that if this radio frequency component of the plate current can be impressed upon the grid circuit in synchronism with the incoming signals, the energy of the original signal will be increased, *i.e.*, regeneration will result.

In brief, regenerative coupling is secured by *coupling the plate and grid circuits, inductively, conductively, or electrostatically.* Electrostatic coupling may be furnished by the tube itself.

26. RADIO FREQUENCY REGENERATIVE CIRCUIT.—

A system for the regeneration of radio frequencies first disclosed by Captain Edwin H. Armstrong is shown (in simple form) in Figure 34. In this diagram, the plate or output circuit of the valve is coupled

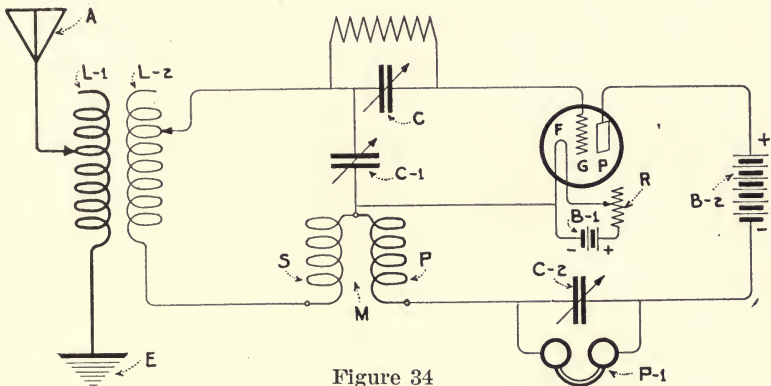

Figure 34

Simple regenerative receiver for the amplification of radio frequencies.

to its grid or input circuit through the *radio frequency transformer M* with the primary and secondary windings *P* and *S* respectively. (The radio frequency components of the plate current are the cycles of **Figure 35** which curve is partially reproduced from **Figure 27.**)

(a) **Phenomena of Regeneration.** Just how the regenerative system amplifies the incoming signals may be explained more in detail, as follows: A very small amount of the energy applied to the grid circuit will release a considerably greater amount of energy on the plate circuit. Part of the energy liberated in the plate circuit is in turn impressed upon the grid circuit through the coupling transformers and the difference between the maximum and minimum potential difference between the grid and filament accordingly increased. Increased energy is then liberated in the plate circuit, but this regenerative process cannot continue indefinitely for the final amplitude of the regenerated current is

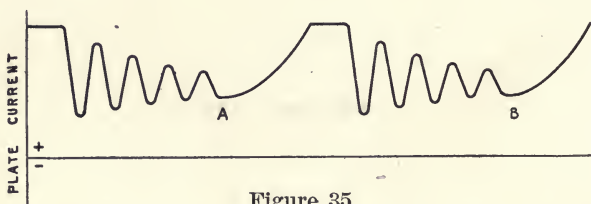

Figure 35
Radio frequency component of the continuous plate current.

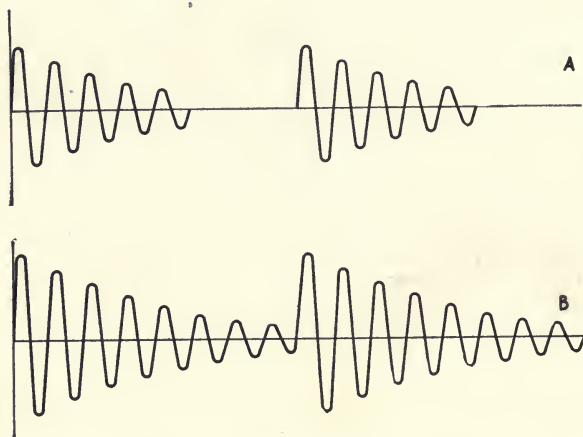

Figure 36
Graphs showing the phenomena of regeneration.

governed by the limitations explained in paragraph 12. Then if an oscillating E.M.F. is impressed upon the grid it is repeated in the plate circuit and through coupling to the grid circuit the energy of the original current is increased.

The effects of regenerative coupling may be shown by the curves *A* and *B*, Figure 36. Curve *A* shows the amplitude of the incoming radio

frequency currents, and curve *B* the increased number of oscillations due to regeneration. If the coupling of the regenerative transformer, such as *M* in Figure 34, is very close the system will be set into *self-oscillation* (at a frequency determined by the inductance and capacity of the circuit) as shown in the curve of Figure 37; but this is a condition of affairs not yet desired in the circuits under consideration.

(b) **Adjustment of Regenerative Amplifier.** In order that the maximum strength of signals may be obtained from a spark transmitter by means of the regenerative system, it is essential that the coupling of the transformer *M** be very carefully adjusted, because (it will be recognized from the curves of Figure 36) if the coupling is too close, the

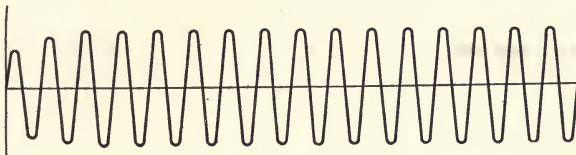

Figure 37

Graph showing the continuous oscillations resulting when the grid and plate circuits of the vacuum tube are closely coupled.

oscillations for each spark at the transmitter will not decay to zero before the next group is impressed upon the valve circuits. Consequently, the desired *change of current* through the head telephone will not be obtained. It must be kept in mind here, that it is not alone the amount of current flowing through the head telephone which produces the greatest strength of signals, but it is the *change* or *variation* in the strength of current as well, which deflects the telephone diaphragm.

The apparatus shown in Figure 34 does not differ materially from that of the tuned circuit for the vacuum valve shown in Figure 28, for in Figure 28 the internal capacity of the tube acts as the regenerative coupling. The complete functioning of the regenerative circuit may be summed up in the following statements:

- (1) The incoming oscillations are repeated in the plate circuit, reinforced through coupling to the grid circuit, causing still greater variation of the grid potential; in the meanwhile, through rectification, a charge piles up in the grid condenser which is negative on the grid side of the condenser. This partially obstructs the flow of electrons to the plate, and thereby reduces the strength of the plate current.
- (2) At the termination of the wave train the charge in the grid condenser leaks off through the shunt resistance, the grid returns to normal potential, and the plate current returns to normal value.

*The statement applies equally well to electrostatic coupling between the grid and plate circuits.

Amplifications of fifty fold are thus secured.

In practice, the best operating characteristic of the regenerative circuit of figure 34 may be secured in the following manner:

- (1) Close the circuit from B-1 through filament F. Find the correct degree of incandescence either by trial or by a small ammeter connected in series with the battery.
- (2) Adjust the E.M.F. of battery B-2 near to the value necessary for the correct operating characteristic (which may be determined in advance in the laboratory or may be found by experiment.)
- (3) While tuning the open and closed circuits of the receiving tuner to the distant transmitter use small values of capacities at C-1, and relatively large values of inductance at L-2.
- (4) Adjust the coupling of regenerative transformer M until maximum strength of signals is secured.

The function of condenser C-2 is to by-pass the radio frequency component of the plate current around the head telephone. Its capacity is generally fixed. The apparatus will function without this condenser, the required capacity being found in the parallel cords of the head telephone.

27. TUNED PLATE CIRCUITS.—We have illustrated in Figure 28, (see paragraph 18), the tuned plate circuit of Armstrong. It was mentioned that amplification of the incoming signal is thus secured.

Either the radio or audio frequency component of the plate current may be amplified by proper tuning.

The explanation given by Armstrong for the operation of this circuit is somewhat as follows:

When the grid circuit is not in a state of oscillation, the potential difference between the plate and filament will be nearly that of the battery B-2, but during the reception of radio oscillations, the potential difference between the plate and filament varies accordingly as the reactance voltage of the coil L-3 assists or opposes the voltage of the local battery B-2.

Then if the current in the plate circuit decreases, the reactance voltage (due to the collapsing lines of force about L-3) will be in the same direction as the voltage of the battery B-2, and therefore there will be an increase of potential difference between the plate and filament. But when the current from battery B-2 increases, the reactance voltage of L-3 will oppose that of the battery decreasing the potential difference between the plate and filament.

It is clear from the preceding explanations regarding the functioning of the three-electrode tube, that when a negative charge is impressed upon the grid, the plate current (the circuit of B-2) decreases, but when

a positive charge is applied to the grid, the plate current increases. Hence, when the filament and grid are connected to a source of radio frequency oscillations, the current in the plate circuit varies as the applied frequency.

Then, when a negative charge is placed on the grid, the plate current is reduced and the reactance voltage of the coil $L-3$ acts in the same direction as $B-2$ and increases the potential difference between the plate and the filament drawing more electrons out on the grid. This increases the charge in the condenser formed by the plate and grid, and the energy for this increased charge is furnished by the inductance $L-3$ as the battery current of $B-2$ decreases.

The increased negative charge on the grid tends to produce a still further decrease in the plate current which causes a still further discharge of energy from the plate inductance $L-3$ into the grid circuit.

But when a positive charge is placed on the grid the plate current is increased and the reactance voltage of $L-3$ opposes the voltage of the battery $B-2$. This reduces the potential difference between the grid and plate, and therefore a part of the energy stored up in the condenser formed by the grid and plate is given back to the plate inductance.

It is at this moment during the cycle that electrons are drawn into the grid in accordance with the valve action and during a group of incoming oscillations a charge is gradually trapped in the condenser $C-2$ which at the termination of a wave train leaks off the grid exerting the usual relaying action on the plate current. This relaying action, during the reception of damped oscillations, occurs at an *audio frequency*.

We then see the necessity for resonance between the plate and grid circuits. In order that the transference of energy from the plate to the grid circuit may take place in synchronism with the incoming oscillations, the circuit $L-3$ and the condenser formed by the self-capacity of the valve must possess substantially the same natural frequency. Then energy will be transferred from the plate to the grid circuit at the proper time to increase the final amplitude of the incoming oscillations, *i.e.*, regeneration will result. This is substantially, *electrostatic regenerative coupling*.

In order that the tuning of the plate circuit may be effective at the lower frequencies corresponding to the longer wave lengths, the coil $L-3$ should be shunted by the condenser $C-3$ as shown by the dotted lines. Armstrong states that the circuit will then function at wave lengths in excess of 10,000 meters.

Other methods for tuning the plate circuit are shown in Figures 38, 39, and 40. In Figure 38, resonance is secured by the variable induct-

ance $L-3$ which at the lower oscillation frequencies is shunted by condenser $C-3$ (of approximately .001 microfarad capacity). Condenser $C-2$ acts as a by-pass for the radio frequency currents around the head telephone and battery. Its capacity may be fixed. The primary coil of the regenerative coupler P is a part of the tuning circuit.

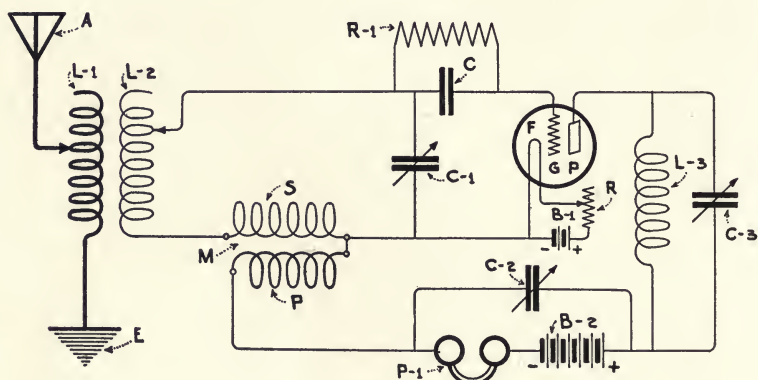

Figure 38

Armstrong's regenerative system (with a tuned plate circuit) for the amplification of radio frequencies.

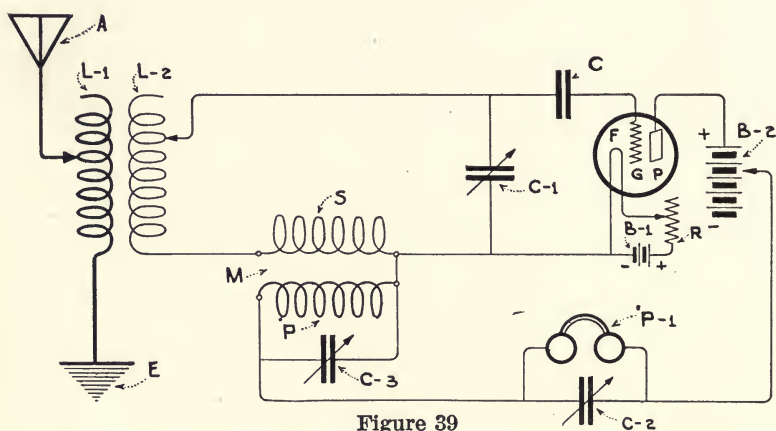

Figure 39

Second method of tuning the plate circuit in a regenerative system.

In Figure 39 the plate circuit is tuned by inductance P and condenser $C-3$, which are proportioned for resonance with the incoming signal.

A third method of tuning the plate circuit is shown in Figure 40, wherein battery $B-2$ and head telephone $P-1$ are shunted by condenser $C-3$, and coils $L-3$ and P . Resonance may be established either by varia-

tion of $C-3$ or $L-3$. Generally, in practice, $L-3$ is fixed, tuning being accomplished through condenser $C-3$. This tuned plate circuit is essentially the "X" circuit developed by Weagant which is described in paragraphs 44 and 45.

28. AUDIO FREQUENCY REGENERATIVE SYSTEM.—

The audio frequency component of the plate current can be re-enforced to amplify the incoming signal by the regenerative transformer M , Figure 41. Windings P and S have inductance of approximately one henry each or more. Condenser $C-2$ serves to by-pass the radio frequency current of the incoming signal, and if of variable capacity, permits circuit S , $C-2$ to be tuned to the audio frequency component of the plate circuit.

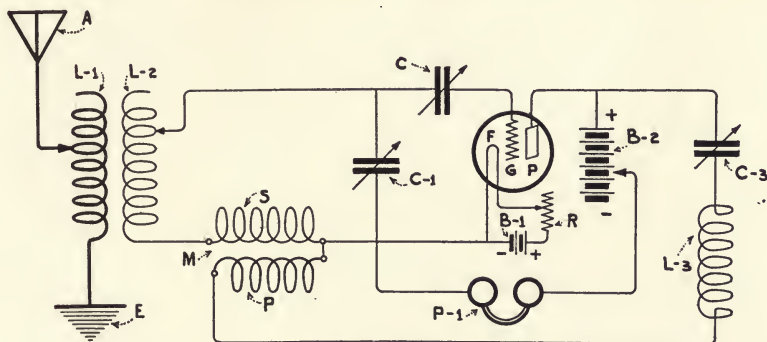

Figure 40

Third method of tuning the plate circuit in a regenerative system.

The circuit, in brief, functions as follows: As the incoming oscillations are rectified and trapped in the grid condenser C , the plate current is gradually reduced (due to the increasing negative potential of the grid). The resulting reduction and subsequent increase of the continuous plate current in turn causes winding P to act inductively upon S , charging the condenser $C-2$ which discharges into the grid circuit causing still greater variation of the plate current. Audio frequency currents are thus amplified.

29. COMBINED AUDIO AND RADIO FREQUENCY REGENERATIVE SYSTEM.—We shall now consider a regenerative system through which both the audio and radio frequency components of the plate current may be amplified through the same bulb. The working of this system will be readily understood by one who has studied the previous regenerative systems.

The circuit is shown in Figure 42. Here $M-2$ is a radio frequency

transformer through which the radio frequency component of the plate current is re-enforced through the grid G .

Transformer $M-1$ is an iron-core audio frequency coupling for amplifying the audio frequency component of the plate circuit, the primary P being shunted by $C-3$, and the secondary S by condenser $C-2$.

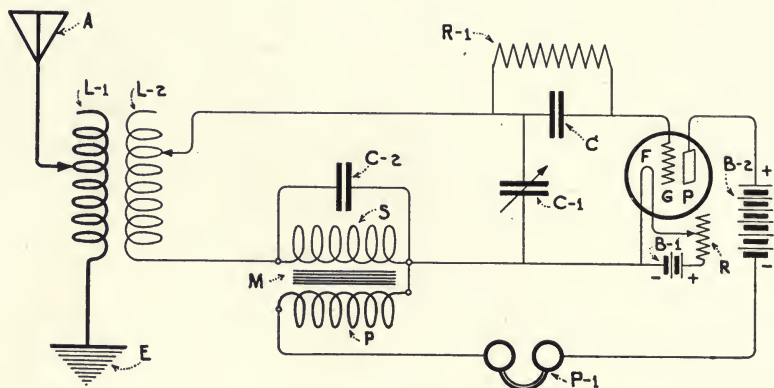

Figure 41

The circuits of an audio frequency regenerative amplifier.

Condenser $C-3$ tunes circuit P , $C-3$ to the desired audio frequency and condenser $C-2$ performs the double function of providing a path for the radio frequency current through the grid circuit and tuning circuit $C-2$, S to the audio frequency component. Condenser $C-4$ provides a path for the radio frequency current around the head telephones $P-2$. Inductance $L-3$ tunes the plate circuit to the incoming signal.

This circuit was first published by Armstrong, who declares that with relatively weak incoming signals a total amplification of 100 is obtained. Some difficulty is experienced in keeping this system in stable operation.

30. ELECTRO-STATIC AND DIRECT MAGNETIC COUPLING.—Additional regenerative circuits* devised by Captain Armstrong are shown in Figures 43 and 44. The grid and plate circuits in Figure 43 are coupled *electrostatically* through condenser $C-1$ and the coil M of audio frequency dimensions completes the circuit for the plate current.

According to Armstrong the apparatus shown in Figure 43 functions as follows: When a positive charge is placed on the grid an increase in the plate current results, the alternating component of the wing cur-

*See *Proceedings of the Institute of Radio Engineers*, Sept., 1915, Vol. 3, No. 3.

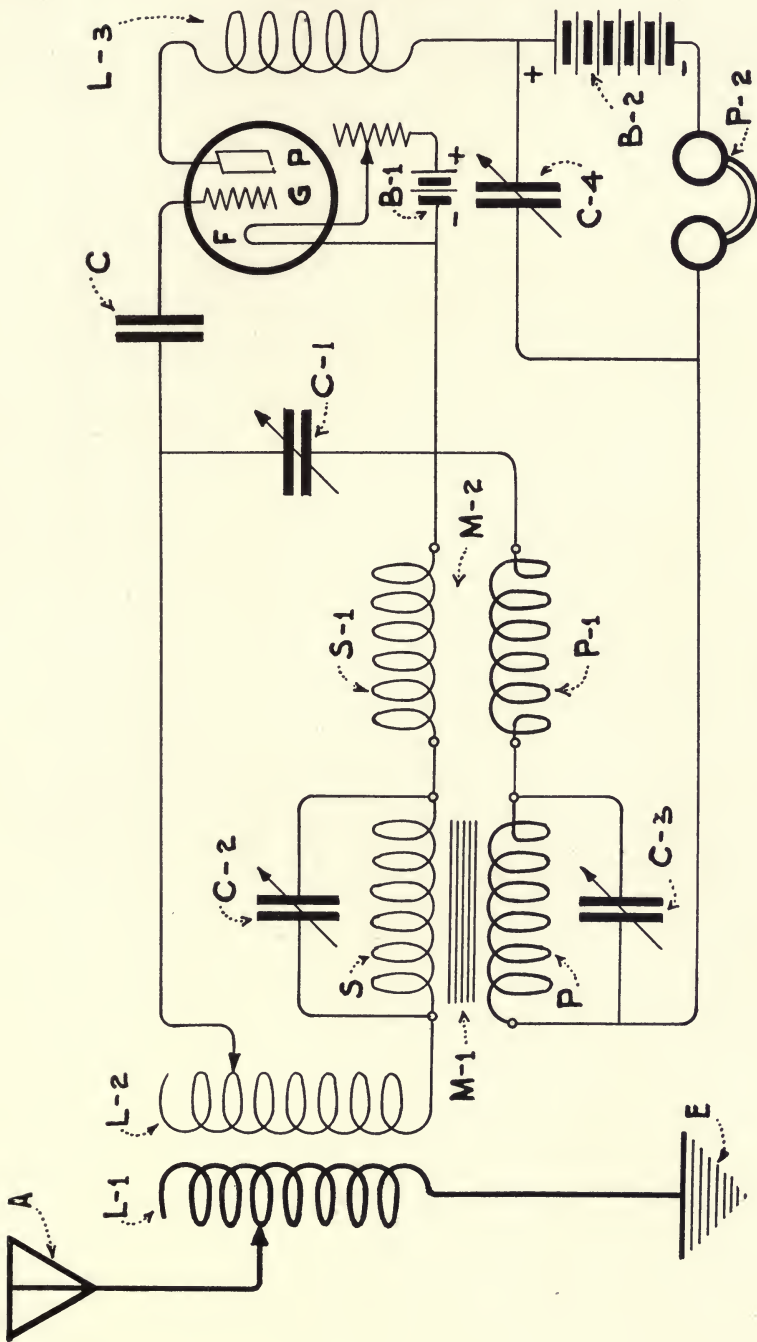

Figure 42

Combined audio and radio frequency regenerative amplifier. Transformer M-1 impresses the audio frequency component of the plate upon the grid circuit. Transformer M-2 performs the same function in connection with the radio frequency component.

rent charging the condenser $C-1$, and the sum of the currents through $C-1$ and M equalling the current through the valve. When a negative charge is placed upon the grid, the current through the valve is reduced and the coil M discharges into condenser $C-1$, charging it in the opposite way to that caused by the increase of the plate current. In either case $C-1$ discharges through the grid circuit re-enforcing the oscillations therein.

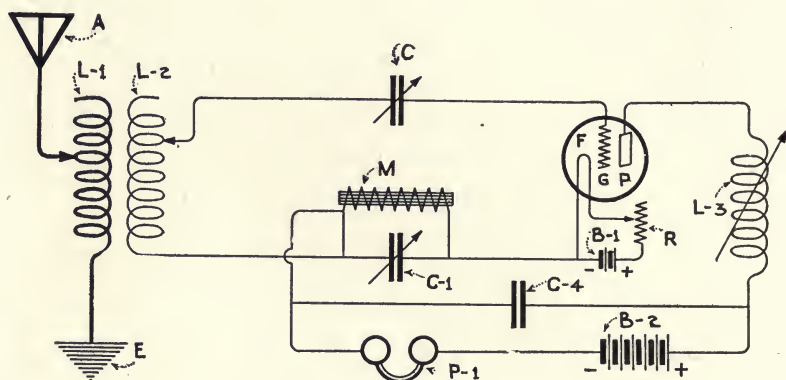

Figure 43

Showing the circuits of Armstrong's regenerative system wherein the plate and grid circuits are electrostatically coupled through a condenser ($C-1$).

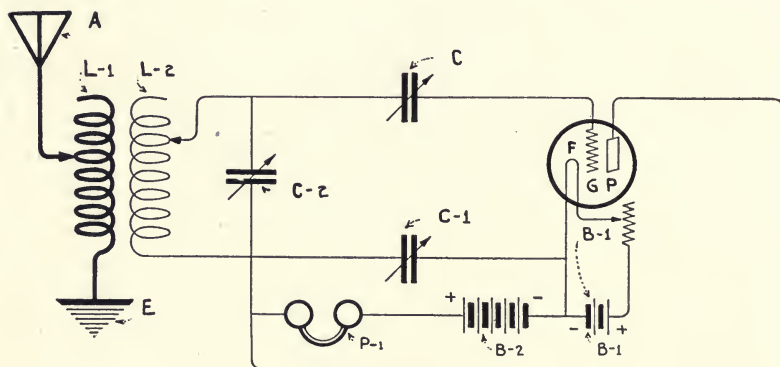

Figure 43a

Ultra-audion circuit for regenerative amplification.

A modification of the arrangement of Figure 43 is in use, known under the trade name of "ultra audion." The circuit arrangement is shown in Figure 43a. Its operation is the same as that of Figure 43 except that radio frequencies alone are regeneratively amplified. It will be seen that this mode of using the coupling condenser $C-1$ in shunt to

both the battery and the telephones results in apparently connecting the secondary oscillation circuit between the grid and plate. This is more apparent than real, however, as it is effectively connected to the filament through the coupling condenser $C-1$.

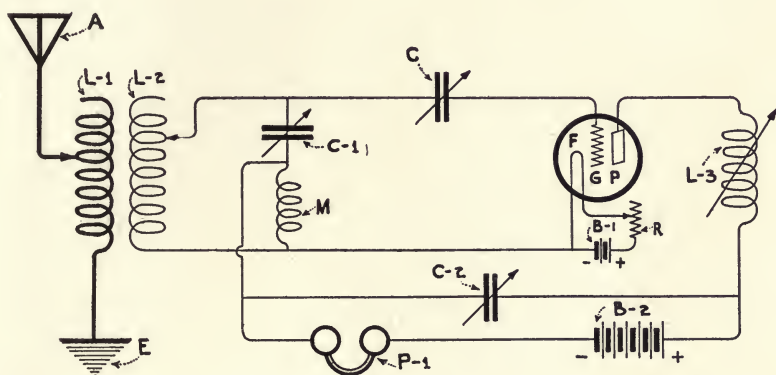

Figure 44

Direct magnetic coupling between the plate and grid circuits of the vacuum tube.

The circuit of Figure 44 functions like Figure 34, conductive regenerative coupling (M) instead of inductive coupling being used.

31. THE "REACTION" CIRCUITS OF FRANKLIN AND MARCONI.—It is customary in England to speak of regenerative circuits as "*reaction*" circuits. The term, in general, refers to a valve circuit in which the grid and plate circuits are coupled magnetically or electrostatically.

An interesting circuit developed by Franklin, of Marconi's Wireless Telegraph Company, Ltd., is shown in Figure 45. It is to be noted in this diagram that the grid and plate circuits are coupled at $L-4$ and $L-5$; that the plate circuit is tuned by $L-5$, $L-6$, $C-1$; and that the secondary circuit of the receiving tuner $L-3$, $L-4$, C , is tuned to resonance with the incoming signal by variable condenser C . Furthermore, the potential of the grid in respect to the filament is adjusted by battery $B-3$ shunted by potentiometer $P-1$.

So far, the circuit does not differ from previous regenerative systems. It will be seen, however, that the plate tuning and coupling elements $L-5$, $L-6$, and $C-1$ are shunted by a crystal rectifier circuit D , $P-2$, $C-2$, $P-3$, $B-4$, the circuit being similar to the closed or secondary circuit of the usual receiving tuner.

Figure 45
The "re-action" circuits developed by Franklin. The grid and plate circuits are coupled through transformer L-4, L-5. The repeated radio frequency oscillations in the plate circuit are detected by a rectifier D and the head telephone P-2.

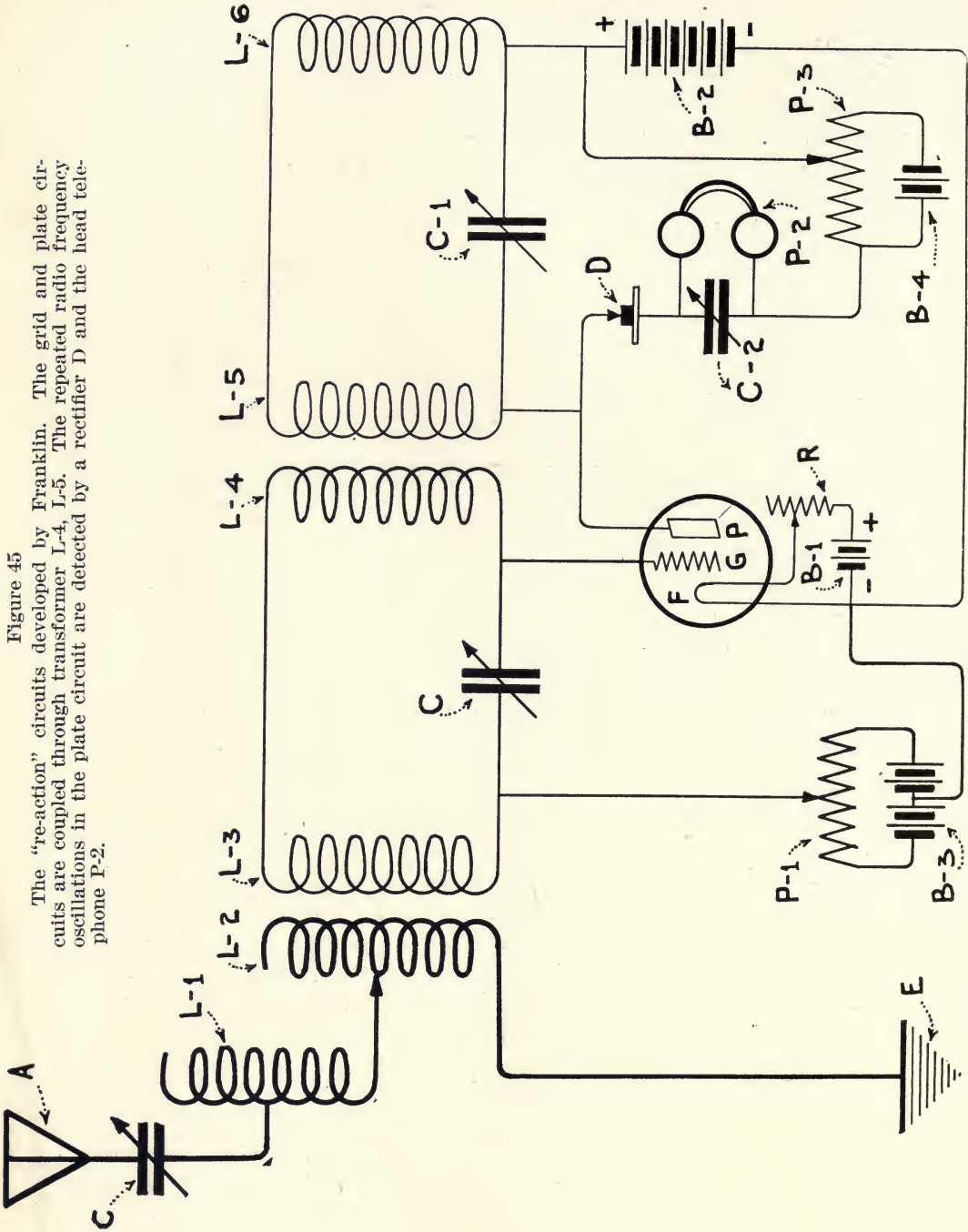

The advantage of a circuit of this kind is as follows: Assume that the incoming signals are too weak to give response in a simple crystal rectifying circuit: then they may be amplified by the vacuum tube in the usual manner. Further amplification may be secured through the *reaction coupling* *L-4, L-5*. Suppose, however, the output current of the valve increases and decreases by equal amounts so that a telephone if placed in the plate circuit would give no response. (This has been explained in paragraph 20). Then the radio frequency component of the circuit may be detected by simple rectification through the crystal *D*; that is, if the amplitude of the positive or negative halves of the plate current have equal value, a telephone connected in series will give no response, but by connecting the crystal rectifier as shown in the diagram, the radio frequency component is rectified and made audible in the head telephone.

Another advantage over the simple crystal rectifier is thus secured, viz., increased selectivity due to the following phenomenon. Normally, let us say the incoming signal is highly damped, consisting of but a few oscillations: the additional energy liberated by the plate circuit through the reaction coupling actually increases the number of oscillations and therefore the circuit acts like one in which the damping has been reduced, *i.e.*, it permits better discrimination between signals of different wave length (or frequency).*

Crystal rectified *D*, obviously, can be replaced by a two-electrode or three-electrode vacuum valve, or by a battery of valves if desired. The system of Figure 45 is applicable to the reception of *damped or undamped oscillations*.

32. SIMPLE REGENERATIVE CIRCUIT.—The circuit shown in Figure 46 has been much used for the reception of damped and undamped oscillations. It is merely an elaboration of that shown in Figure 43a. A point of departure from other systems is the method of connecting the terminals of the secondary coil *L-2* to the valve. One terminal connects through the grid condenser *C* to the grid *G*, and the opposite terminal to the plate *P*. There has been much argument concerning the functioning of this circuit, but careful scrutiny reveals that the grid and plate circuits are electrostatically coupled through condenser *C-2*. Additional magnetic coupling is afforded through coils *L-3* and *L-4*, but as first used, the condenser *C-2* provided the entire regenerative coupling. The inductive coupling permits a greater amount of energy to be supplied to the grid circuit by the plate circuit, and is useful for giving

*This, of course, is true of all regenerative circuits.

stability in the reception of undamped oscillations by the beat method (to be described more in detail further on).

The diagram of Figure 46 also shows how the *plate circuit* of a vacuum valve may be fed with direct current from a dynamo. Ordinarily the fluctuations of current due to the commutator would cause an

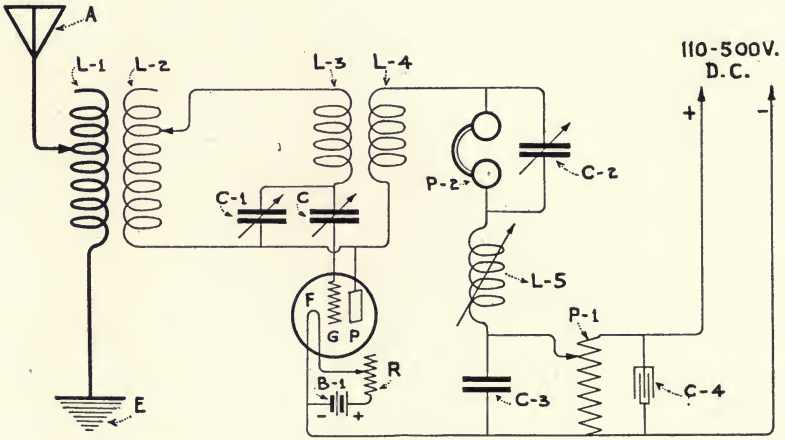

Figure 46

Showing how the plate circuit of a vacuum tube may be energized by a direct current dynamo. The strength of the local current is regulated by the potentiometer P-1, and the fluctuations of the dynamo current due to the commutator are smoothed out by the condenser C-4. Inductive regenerative coupling is provided between the coils L-3 and L-4, and electrostatic regenerative coupling by the telephone condenser C-2. The coil L-4 is often termed the "tickler" coil.

interfering "hum" in the receiving telephones, but this is largely prevented by shunting to the D. C. line a condenser of large capacity, C-4, which has the effect of smoothing out the current, that is to say, when the current generated by the dynamo decreases, the energy stored up in the condenser C-4 discharges through the circuit and maintains the line voltage at a nearly constant value. Potentiometer P-1, permits the plate voltage to be adjusted to the requisite value, and condenser C-3 acts as a by-pass for the incoming radio frequency currents.

PART V

COMBINED REGENERATIVE AND CASCADE AMPLIFICATION SYSTEMS

33. **IN GENERAL.**—We next come to amplification circuits which embrace the two systems of amplification previously described, namely, the *regenerative amplifier and the cascade amplifier*. Other circuits than those described herein can be devised by the experimenter, the connections for which will suggest themselves to one who has studied previous chapters.

34. **REGENERATIVE CASCADE SYSTEMS.**—In the diagram of Figure 47, is shown a system in which the incoming oscillations are amplified in the first valve through *regenerative coupling*, the amplified radio frequency component of the plate current being impressed upon the grid and filament of the second valve where it is further amplified by a second regenerative coupling, the amplified energy finally being *rectified and trapped* in the grid condenser of the last valve.

The student who has carefully studied the principle of operation of the apparatus noted in connection with previous diagrams will readily recognize the features of Figure 47.

First, the potential of the grid in respect to the filament of the first valve is adjusted by the grid battery, *B-3*, and the potentiometer *P-3*. Second, if the voltage of the plate circuit and the temperature of the filament are adjusted to operate upon the slope *A'*, *B'* of the characteristic curve (Figure 22), substantially equal increases and decreases of the plate current will be secured for a given incoming radio frequency current and a distortionless radio frequency current obtained in the plate circuit of the first valve.

Part of the energy liberated by the plate circuit of the first valve is impressed upon its grid circuit through the radio frequency transformer

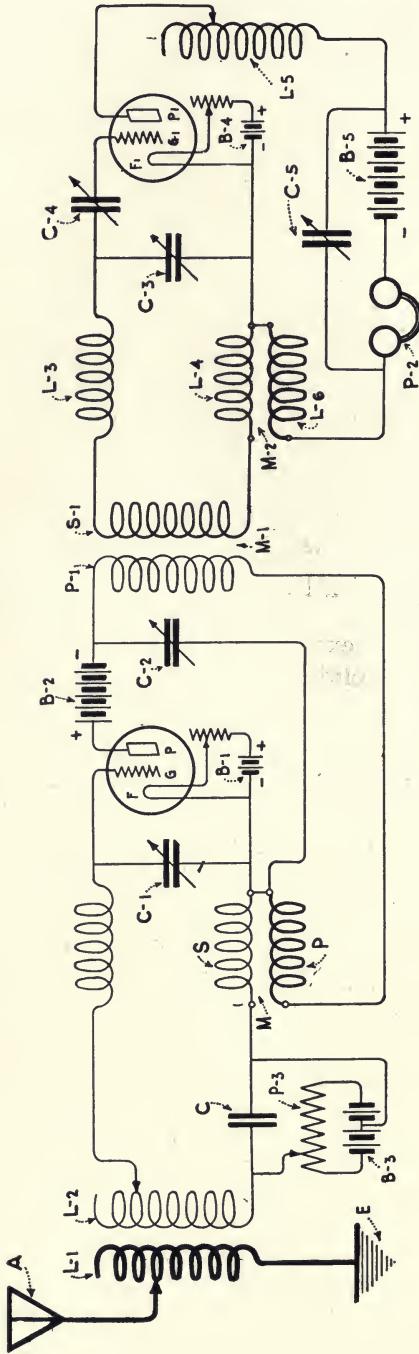

Figure 47

Combined regenerative and cascade amplifier. In this system the incoming radio frequency oscillations are amplified by regenerative coupling through transformer M and the amplified radio frequency component of the continuous plate current is impressed upon the grid circuit of the second vacuum valve through the radio frequency transformer M-1. The radio frequency oscillations repeated in the plate circuit L-5, C-5, C-4, L-6, are amplified through the regenerative coupling M-2.

The amplified oscillations are rectified by the valve action between the grid G and the filament F, and a charge is placed in the condenser C-4 over the duration of the wave train. The increasing charge in the condenser C-4 reduces the plate current, but at the termination of the wave train the charge leaks out of this condenser, and the plate or telephone current returns to normal strength. This action occurs at an audio frequency.

M, which, in turn, causes an amplified radio frequency current in the plate circuit, *P*, *P*-1, *C*-2. Through the radio frequency transformer *M*-1, this current is impressed upon the grid circuit of the second valve, *S*-1, *L*-3, *C*-3, *L*-4.

The incoming signal is then repeated in the plate circuit *L*-5, *C*-5, *L*-6, of the second valve where it is further amplified through the regenerative coupling *M*-2. The amplified radio frequency currents are finally rectified to charge the grid condenser *C*-4, which exerts a relaying action on the plate current of the second valve at an audio frequency. Although the plate circuit of the second valve is tuned by the coils *L*-5, *L*-6 and the condenser *C*-5, an untuned circuit may be employed.

It is not always essential in a system of this kind that the plate circuit of the first valve be tuned to the incoming radio frequency currents, but for the best signals it is of prime importance that the grid circuits of both valves be thus tuned. This is accomplished mainly by condensers *C*-1, and *C*-3, the usual secondary condensers. Variation of *L*-2, *L*-3, *L*-4, *P*-1, etc., is necessary to obtain a wide range of frequencies.

In practice, the coupling of transformer *M*-1 is very close and is usually fixed. Very careful adjustment of the couplings *M* or *M*-2 is necessary, or otherwise the valves will be set into self-oscillation at an audio or radio frequency.

Summarizing the functioning of the circuit of Figure 47:

- (1) The incoming radio frequency oscillations are repeated in the plate circuit of the first valve and amplified through the regenerative coupling *M*, then impressed upon the grid of the second valve through *M*-1, and further amplified through coupling *M*-2.
- (2) This amplified current is rectified by the valve action between *G* and *F* and over the duration of a wave train a charge piles up in the grid condenser *C*-4.
- (3) The charge in this condenser raises the potential of the grid to a high negative value, reducing the plate current.
- (4) At the termination of the wave train this charge leaks out the grid condenser and the plate current returns to normal value. This variation of the plate or telephone current occurs at an audio frequency.

This circuit will function with or without the grid condenser *C*-4 of the second valve. A battery with a potentiometer may be connected in the grid circuit and the potential of the grid in respect to the filament adjusted until an asymmetrical relaying effect is obtained in valve No. 2. Condenser *C* acts as a by-pass for the radio frequency currents around the potentiometer.

35. AUDIO FREQUENCY REGENERATIVE AND CASCADE SYSTEMS.—By employing the connections shown in Figure 48,

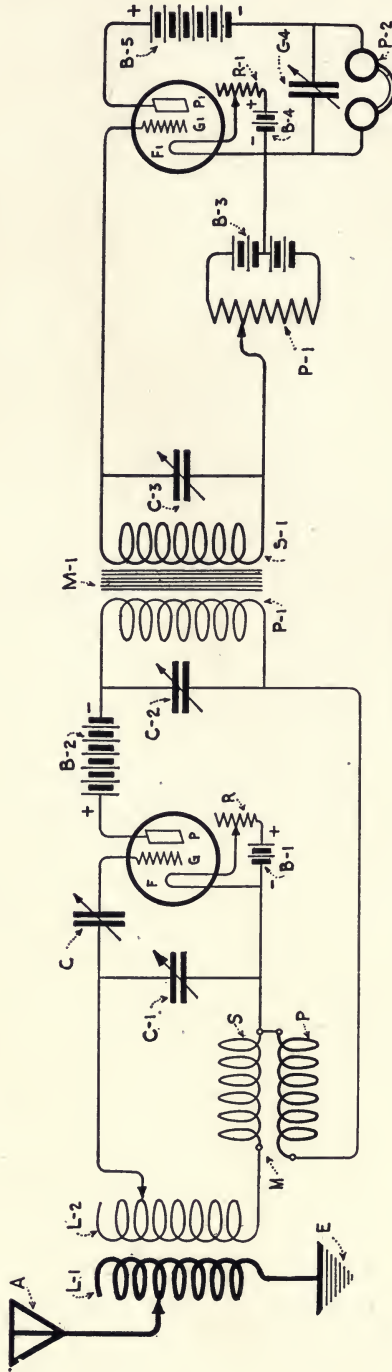

Figure 48

Showing the circuits of a regenerative cascade system wherein the incoming signals are first amplified through the regenerative transformer M. The audio frequency current of the plate circuit is then impressed upon the grid circuit of a second valve through coupling transformer M-1. Circuit S-1, C-3, may be tuned to the audio frequency current.

the radio frequency component of the plate circuit of the first valve is first amplified by the regenerative coupling M and then, through the iron core transformer $M-1$, the audio frequency component of the plate current is impressed upon the grid and plate of the second valve.

In this diagram, the circuit of the first valve includes the grid condenser C , in which the incoming oscillations are trapped after rectification. The iron core transformer $M-1$ has the primary winding $P-1$ and the secondary winding $S-1$ which is connected to the grid or input circuit of the second valve. Condenser $C-2$ acts as a by-pass for the radio frequency currents of the plate circuit around the audio frequency inductance $P-1$. The audio frequency current impressed upon the grid circuit of the second valve is increased in amplitude by tuning the grid circuit through the shunt condenser $C-3$. The inductance of $P-1$ and $S-1$ may be several henries. A step-up ratio of turns is usually employed.

The potential of the grid circuit of the second valve is adjusted to secure the maximum signals through potentiometer $P-1$ and battery $B-3$.

In practice as many as six valves have been connected in cascade with the connections of either Figure 47 or 48. Generally, however, three valves will give sufficient amplification for all commercial requirements. An audio frequency regenerative coupling might be employed with the second valve of Figure 48.

PART VI

THE VACUUM TUBE AS A DETECTOR OF CONTINUOUS WAVES. AUDIO FREQUENCY TUNING CIRCUITS. SPECIAL CIRCUITS FOR THE VACUUM TUBE

36. RECEPTION OF CONTINUOUS OSCILLATIONS.—The problems encountered in the reception of continuous waves in radio telegraphy have been reviewed briefly in the introduction. The vacuum tube can be connected in many ways for the reception of continuous waves as will be shown in the circuits following.

By way of preliminary explanation, we may assume that a simple crystal rectifier is connected in the circuit of the usual receiving transformer, and that the complete receiving system is tuned to a *continuous wave transmitter*; as has already been shown, a rectified current of continuous amplitude or uniform intensity would flow through the telephone. Because the frequency of these rectified or direct-current pulses is above audibility, no sound will be obtained from the telephone diaphragm except at the opening and closing of the circuit. Let, however, a mechanical interrupter, such as the well-known "*tikker*" or "*slipping contact*" detector, be connected in some circuit of the receiving system, and be adjusted to interrupt the incoming signals from 600 to 900 times per second; then the telephone will be energized periodically at an *audio frequency*.

These interruptions (by the *tikker*) do not take place in synchronism with the incoming oscillations, that is, energy is discharged into the telephones at different portions on the cycles of the incoming oscillations, and as a consequence a somewhat irregular deflection of the telephone diaphragm is obtained. In other words, the note produced in the telephone lacks the musical characteristic so desirable for working through atmospheric electricity. This defect is partially obviated by the "*slip-*

ping” contact detector, which impulses the telephone diaphragm at a slightly more uniform rate.

The solution of the problem is largely attained by a form of the “tikker” known as the *tone-wheel*, which converts the incoming oscillations into a practically uniform current of audio frequency. The signal is therefore heard as a musical note in the telephone. This desired effect is obtained by driving the “tikker” or circuit interrupter at such speed that the receiving circuits are interrupted at a rate slightly off synchronism with the incoming currents, thus producing in the telephone receiver a note having a frequency corresponding to the difference between the actual speed and the synchronous speed.

To illustrate its action: If the frequency of the incoming oscillations at any receiving station is 50,000 cycles per second, and the tikker interrupts the circuit 50,000 times per second (in exact synchronism or at the peak of every other alternation), then either the positive or negative half of the incoming oscillations will be suppressed and the telephone will be traversed by uni-directional impulses of radio frequency. If, however, the “tikker” interrupts the circuit at a rate different than the fundamental frequency, say, 49,500 times per second, the wave form is interrupted at points on and off the successive peaks, which results in the production of an audio frequency current, the frequency of which is the difference between the frequency of the incoming signals and the interruptions of the tikker. In the problem cited, the telephone diaphragm will be deflected 500 times per second.

Although the Goldschmidt tone-wheel is practicable for radio reception at low frequencies from 25,000 to 60,000 per second, it is not so at the higher frequencies such as 500,000 cycles per second corresponding to the wave length of 600 meters. The mechanical problems involved in the construction of a device to interrupt the circuit one-half million times per second are too obvious for discussion.

Another system for obtaining audible response from radio frequency currents is known as the *beat receiver*. A musical note is secured in the telephone in this system, the pitch of which may be varied within the limits of audibility.

The underlying principle of operation follows: *Two radio frequency* currents of slightly different frequency superposed upon the same circuit, interact and produce a third current termed a “beat” current.* By proper selection of the interacting frequencies the frequencies of the beats may range from 200 to 1,000 cycles per second.

*See page 5.

For example, if the antenna circuit of a receiving system is adjusted to a transmitter whose frequency of oscillation is 50,000 cycles per second, and there is induced in some part of the receiving system a locally generated radio frequency current of 49,500 cycles per second, beat currents of a frequency of 500 per second will result. The beat currents may then be rectified to energize a magnetic head telephone in the usual manner.

37. THE THEORY OF THE BEAT RECEIVER.—The general theory of the beat receiver may be explained by the curves, Figures 49 to 52 inclusive. We have stated in the previous paragraph, that the

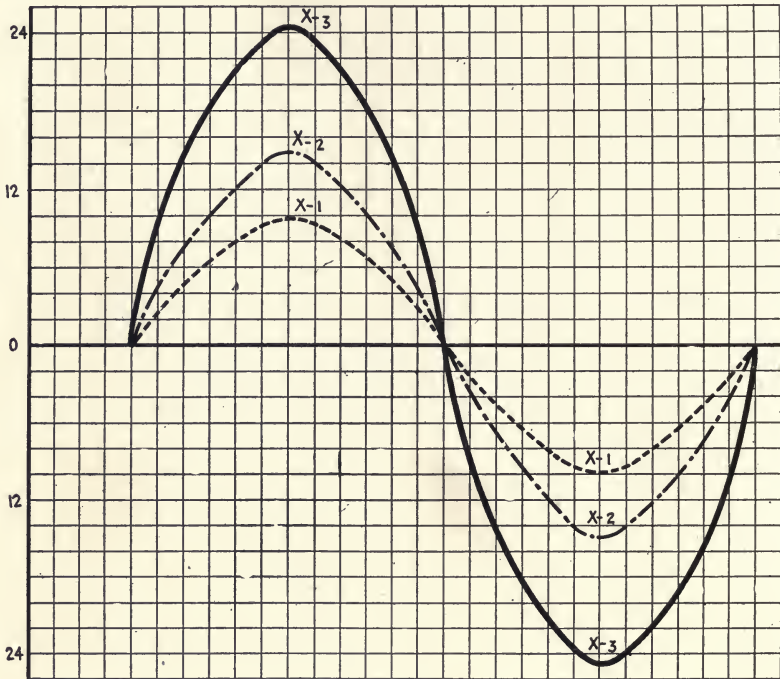

Figure 49

Showing the current curve resulting from the addition of two currents of the same frequency but of different amplitude applied to the same circuit.

requisite current of audio frequency for operation of the head telephone receiver in the beat system of continuous wave reception, is obtained from the interaction of two *radio frequency currents of slightly different frequency*. Just how this audio frequency current is obtained, can best

be understood by comparing the action of two currents of the same frequency which reach their maximum and minimum amplitudes simultaneously or at different moments; that is, two currents of the same frequency applied to the same circuit identical in phase, or out of phase.

Let the diagram of Figure 49 represent two currents in exact phase in a given circuit, *i.e.*, currents that reach their maximum and minimum amplitudes simultaneously, but possess different amplitudes. Curve X-1 has a maximum value of 10 milliamperes, and curve X-2, 15 milliamperes. The resultant current will have the maximum amplitude shown by the

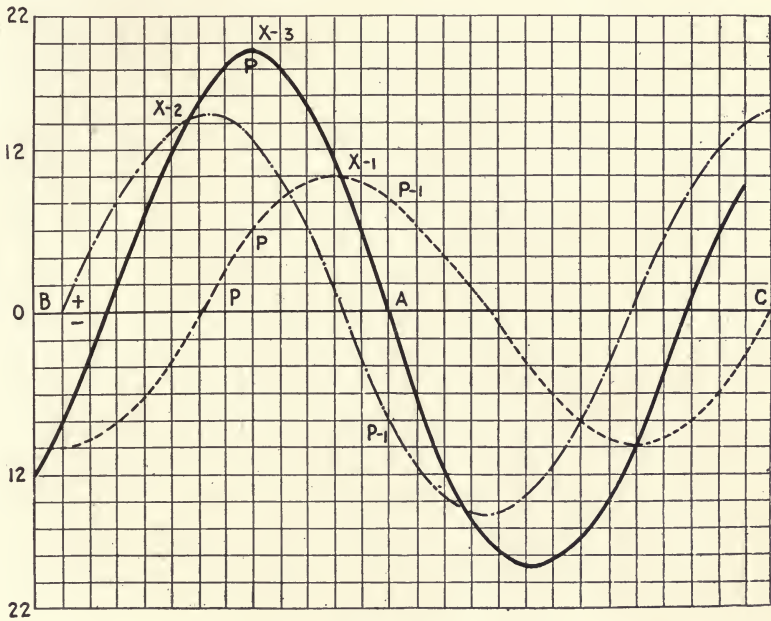

Figure 50

The curve resulting from two currents of similar frequency slightly out of phase.

third curve X-3, 25 milliamperes. In other words, the resulting current is obtained simply by adding the amplitudes of the two currents.

In Figure 50, the two currents are *out of phase* a few degrees, that is, they do not reach their maximum amplitudes simultaneously; therefore, the amplitude of the resultant current will be much less than that of Figure 49, for reasons now to be explained: The maximum amplitude of the resulting current in this case can be found in the same way, by simply adding the values of the amplitude of the currents at any given moment during the cycle. It should be noted, however, that

at certain portions of the cycle these two currents oppose. At P , Figure 50, the value of current $X-1$ is 6 milliamperes and of $X-2$, 13 milliamperes. The amplitude of the resultant current $X-3$ is $6 + 13$, or 19 milliamperes. Again at Point $P-1$, the value of current $X-1$ is $+ 8$ milliamperes and of current $X-2 - 8$ milliamperes. The amplitude of the resultant current, therefore, is *zero*, as shown at point A on the horizontal axis B, C .

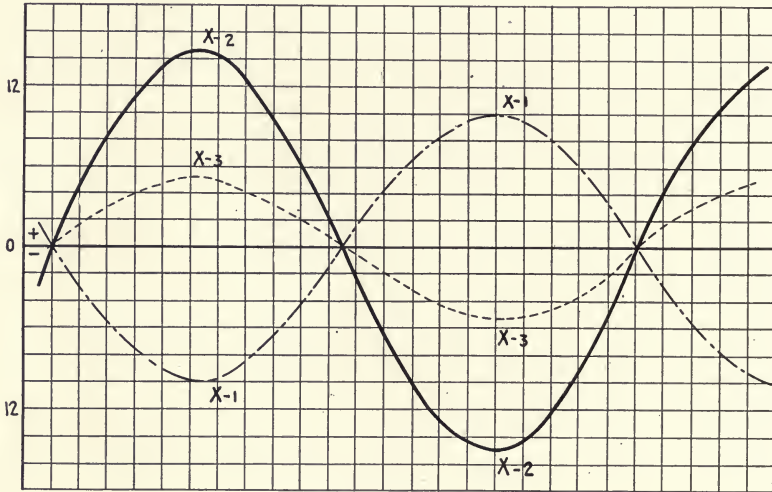

Figure 51

The resultant curve of two currents 180° out of phase but of different amplitude.

In the diagram of Figure 51, two currents differ in phase relation by 180° and therefore they oppose at all points during the cycle, that is, positive and negative maximums are reached simultaneously. It is self-evident that if they possessed *equal amplitudes* the amplitude of the resultant current would be *zero*, but since $X-1$ represents a value of, let us say, 10 milliamperes and $X-2$ a value of 15 milliamperes, the maximum amplitude of the resultant current is 5 milliamperes as shown by the curve $X-3$.

(a) **Phenomenon of Beats.** Up to this point, we have dealt with currents of similar frequency, but of different phase relation. When two currents of *different frequency* are applied to a given circuit, they will successively add up or subtract their amplitudes, *i.e.*, their *phase relation changes progressively from 0° to 180° and back to 0°* ; that is, at certain moments (during a second) the two currents flow in phase adding up

their maximum values, while at other moments they are 180° out of phase and the amplitude of the resultant current is zero. At all intermediate points, the two currents either *add* up or *subtract*.

The interaction of the two currents causes a periodic variation of the amplitude of the resultant current which occurs at a frequency different from either of the applied frequencies. This resultant current is called a "*beat*" current, and it can be shown that the frequency of the beat current is equal to the numerical difference of the two applied frequencies. Thus, if a current of 50,000 cycles per second interacts with another current of 49,500 cycles per second, the *frequency of the beat currents* will be $50,000 - 49,500$ or 500 per second.

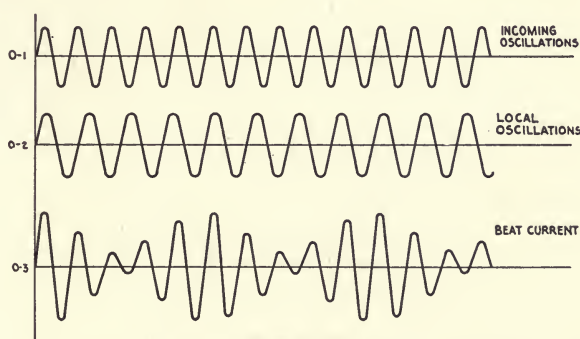

Figure 52

Graphs showing the beat currents resulting from the interaction of two currents of different frequency.

It follows that if a current of 100,000 cycles per second interacts with another of 101,000 cycles per second, the frequency of the "beats" will be 1,000 per second, and so on. The production of beats by the interaction of two currents can best be explained by the diagram of Figure 52, wherein the line *O-1* represents a current of 250,000 cycles per second, and the line *O-2* a superposed current of 200,000 cycles per second. The frequency of the beat current shown on line *O-3* in this case is 50,000 cycles per second, which is, of course, above the limits of audibility and will produce no sound in the telephone receiver. (A difference of frequency so great as this had to be selected in order that several cycles of the resultant beat current could be plotted to scale.)

It is now clear that by proper selection of the frequencies of the interacting currents beats of any desired audio frequency may be secured.

We may review the foregoing facts as follows:

- (1) If two currents of the same frequency and like phase flow in a circuit, the amplitude of the resultant current will be the sum of the amplitudes of the individual currents.

- (2) If two currents of dissimilar phase but of similar frequency flow in a circuit, the amplitude of the resulting current is found by adding their amplitudes at any particular moment.
- (3) If the currents differ in phase by 180° the amplitude of the resultant current will be zero if the two currents are of identical amplitude, or if of different amplitude the resultant current will be the difference of the amplitude of the two currents.
- (4) If two currents of unequal frequency are applied to a given circuit, they will add or subtract their amplitudes periodically resulting in the production of a beat current the frequency of which is the numerical difference of the two applied frequencies.

We shall presently see how this principle is applied to the *reception of undamped or continuous waves* in radio telegraphy.

38. THE SIMPLE HETERODYNE.—It has been already explained that if a receiving antenna and associated receiver circuits containing a simple rectifier are tuned to a continuous wave transmitter, the receiving telephone will be traversed by a uni-directional current as

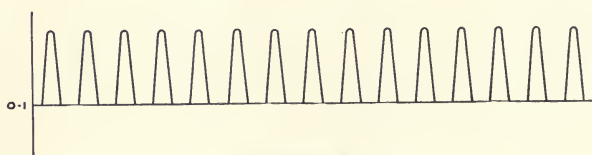

Figure 53

Showing the rectified current pulses in the local telephone circuit of a receiving system containing a simple rectifier.

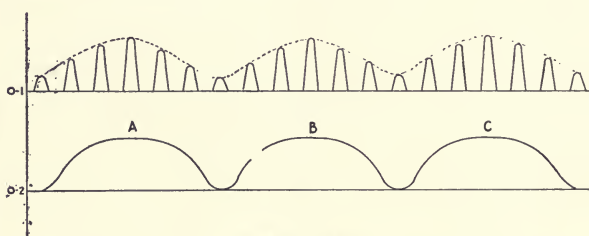

Figure 54

Showing how the amplitude of direct current pulses (above audition) can be varied at an audio frequency.

shown in graph O-1, Figure 53. This represents the rectified current of an incoming group of oscillations. The individual pulses of the graph occur at a radio frequency and therefore, the telephone emits no sound. But if by local means we cause the amplitude of these pulses to fluctuate periodically at an audio frequency as shown in graph O-1,

Figure 54, sound will be produced because the telephone diaphragm will be deflected at rates varying as the *periodic fluctuations* of the rectified current.

The telephone current will be approximately that of the graph *O-2*, in which successive curves *A, B, C* represent the average effect of the individual groups of pulses in the graph *O-1*. This is what occurs in the circuits of the *simple heterodyne receiver* shown in Figure 55.

As in the usual receiving circuit employing a crystal or solid rectifier, the primary winding is represented by the coil *L-1*, the secondary winding by the coil *L-2*, the crystal detector by *D*, the shunt secondary condenser by *C-2*, the telephone condenser by *C-1*, and the head telephone by *P*. A radio frequency alternator of variable frequency *A-1*, is inductively coupled through *L-3* to the antenna coil *L-4*.

The operation of this system in brief is as follows: Assume that the antenna circuit *L-1, L-4, A, E*, is tuned to 8,000 meters, the oscillation frequency of this circuit is $\frac{300,000,000}{8,000}$ or, 37,500 cycles per second. The

frequency of the current induced in the secondary circuit *L-2, C-2* and impressed across the oscillation detector *D*, is also 37,500 cycles per second, and, for reasons already explained, the telephone diaphragm emits no sound. But if the frequency of the alternator is 36,500 cycles

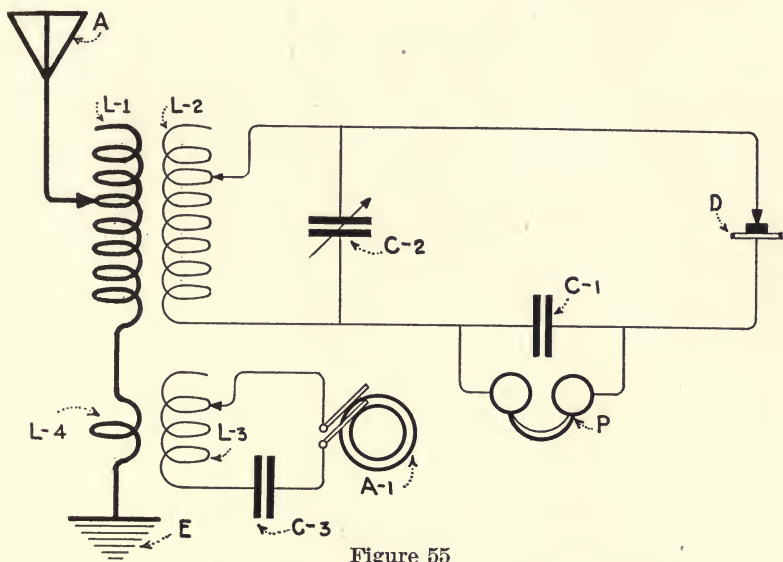

Figure 55

The circuits of a simple beat receiver. Local oscillations are generated by the radio frequency alternator, vacuum tube or arc generator *A-1*. The resulting beat currents are detected in the circuit *L-2, C-2, D, C-1, P*.

per second, the amplitude of the oscillations in the entire system will be varied from a maximum to a minimum at a rate due to the difference of 37,500 and 36,500 or 1,000 per second, *i.e.*, the frequency of the "beat" currents will be 1,000 per second. These beats in turn are rectified by the detector *D* and 1,000 *pulses of direct current* per second energize the telephone *P*.

The same beat frequency will be obtained if the alternator *A-1* is adjusted for 38,500 cycles per second; that is, the frequency of the "beats" in every case equals the *difference of the two applied frequencies*.

By changing the frequency of the alternator *A-1*, the receiving operator can change the pitch of the beat note from, say, 200 cycles to 1,000 cycles per second or beyond the limits of audibility. Not only can the note be varied according to the desire of the operator, but it can be shown that the efficiency of the receiver is thus increased, *i.e.*, *amplification* of the incoming signal is secured.

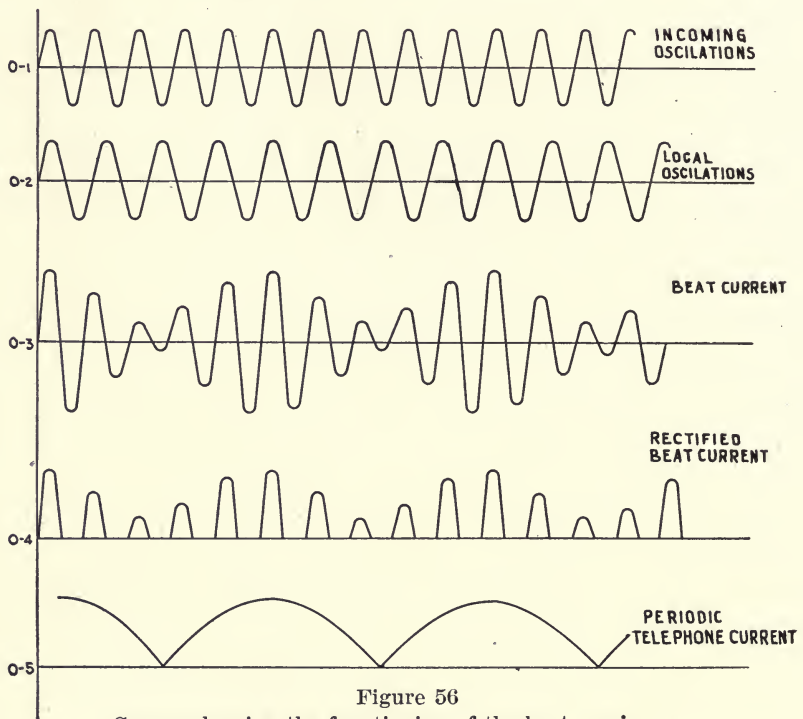

Figure 56
Curves showing the functioning of the beat receiver.

(a) **Curves of the Beat Receiver in Radio.**—The complete processes involved in the detection of continuous oscillations by this method (Figure 55) are shown graphically in the series of curves, Figure 56,

where *O-1* represents the incoming oscillations; *O-2*, the locally generated current; *O-3*, the resulting beat current; *O-4* the rectified beat current; and *O-5*, the approximate telephone current. It is to be noted that the amplitude of the beat current exceeds the amplitude of either the locally generated current or that of the incoming signal.

It would be well for the student here, to bear in mind that the radio frequency alternator *A-1* can be replaced by:

- (1) An arc generator such as the Poulsen type.
- (2) A vacuum tube oscillator.

The complete circuit for (2) is shown and described in paragraph 41.

39. SELECTIVITY BY THE HETERODYNE.—In addition to the selectivity afforded by the usual radio frequency tuning of the receiver circuits, an additional discrimination between different stations operating near the same wave is secured by reason of the beat phenomenon.

If the frequency of the incoming oscillations from the station desired is, for example, 37,500 cycles per second ($\lambda = 8,000$ meters) and the frequency of the local oscillations 36,500 cycles ($\lambda = 8,219$ meters) the beat pitch will be 1,000 per second. Suppose, however, that another station sends at a wave length corresponding to a frequency of 37,000 cycles per second ($\lambda = 8,108$ meters), then a beat note of 500 per second will be obtained, and due to the differences of tone, the operator can concentrate on the particular signal he desires to receive.

Then if several undamped wave transmitters operate simultaneously at such wave lengths as to produce a beat note in the receiving apparatus when its locally generated current is adjusted to a certain frequency, the operator in many cases can change the pitch of the beat note of the station he desires to receive, to a pitch that will permit him to concentrate on that signal to the exclusion of others.

Also, if the frequency of the local current is maintained at a definite value, signals will be heard only from such stations as will produce a beat pitch between the values of, say, 16 to 10,000 per second. It must be remembered, however, that the best response is generally obtained when the beat pitch is somewhere near the value of 1,000 per second.

It is easily seen from the foregoing, that if the frequency of an interfering signal is sufficient to cause a beat current of a frequency above or below the limits of audibility, it will not be heard in the telephone even if the receiving station is near enough to the transmitter to be energized by forced oscillations.

As will be shown in paragraph 43 an audio frequency tuning circuit can be connected to the plate circuit of the vacuum tube detector, requiring the receiving operator to tune to the beat frequency as well as to the radio frequency oscillations.

In summary, there are three modes of obtaining selectivity in a beat receiver:

- (1) by radio frequency tuning;
- (2) by change of the beat note;
- (3) by audio frequency tuning.

The student will comprehend this more clearly from the instructions to follow.

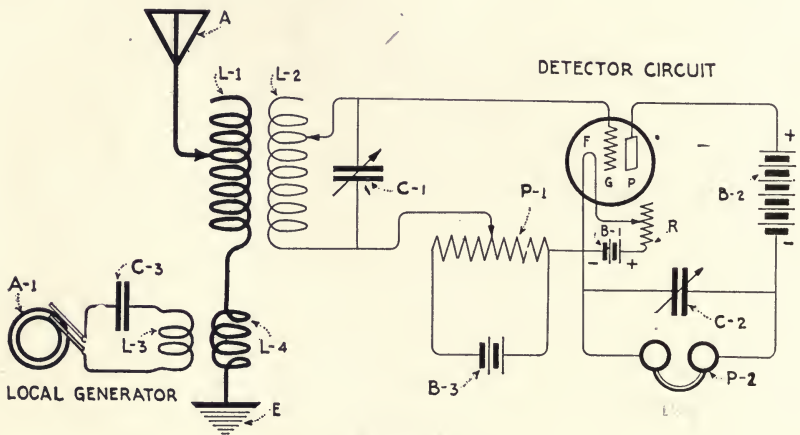

Figure 57

The vacuum tube as a detector in the beat receiver.

40. HETERODYNE WITH THE VACUUM VALVE AS A DETECTOR.— We next consider the use of the three electrode vacuum tube as a detector in the heterodyne system in place of the carborundum rectifier. In the diagram of Figure 57, the crystal rectifier of Figure 55 has been replaced by a vacuum tube F, G, P , adjusted for *assymetrical relaying*, i.e., the potential of the grid to filament is controlled by a grid battery $B-3$, to secure the best relaying effect.

If the alternator $A-1$, adjusted to a frequency slightly off the signal frequency is coupled to the antenna at coils $L-3$ and $L-4$, an E.M.F. at a radio frequency will be induced across the terminals of $L-4$. Currents of similar frequency will flow in the complete antenna system. Currents of the same frequency will be induced in the secondary or detector circuit $L-2, C-1$, and the plate current will rise and fall at a

radio frequency as shown by the graph, Figure 58. Since the variations of the plate current occur at a radio frequency, and have constant amplitude, no response is obtained in the head telephone *P*, but this current flows in the plate or output circuit so long as the alternator *A-1* is in operation.

Assume, however, that a distant transmitter induces continuous oscillations in the receiving aerial at a frequency differing from the local frequency by 500 to 1,000 cycles; these oscillations will interact with the locally generated oscillations producing *beats* which have ampli-

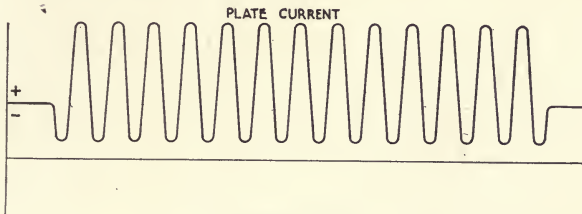

Figure 58

Showing the repeated oscillations (in the plate circuit) when the valve is operated at a certain point on the characteristic curve. Undamped oscillations are assumed to be impressed upon the grid circuit.

tude greater than either the signalling frequency or the local frequency. That is, as the two currents add up or subtract, the potential of the grid will be raised and lowered above and below the potential supplied by the incoming signal. Then, if the grid potential is adjusted so that a rectified current flows in the plate circuit, the telephone will respond to an average effect of each group of beat currents. In this way the plate current varies at the frequency of the beats and the telephone diaphragm is deflected accordingly.

Diagrammatically, the actions of the circuit in Figure 57 are shown in Figure 59, it being assumed that the grid potential of the detecting tube is adjusted so that a rectified current flows in the plate circuit. Curve *O-1* represents the frequency of the incoming signal; curve *O-2*, the locally generated current; curve *O-3*, the beat current; curve *O-4*, the modulated plate current, and curve *O-5*, the approximate telephone current.

Further amplification of the beat current can be secured by providing the system of Figure 57 with a regenerative coupling (audio or radio frequency), but the coupling must not be too close or the valve will be set into self-oscillation—a state of affairs not desired with this particular set of connections.

41. THE VACUUM VALVE AS A GENERATOR OF RADIO FREQUENCY OSCILLATIONS.—A vacuum tube connected as in Figure 60 may be employed to generate the local radio frequency currents for beat reception. The grid and plate circuits are coupled through coils $L-2$ and $L-3$. The grid circuit is tuned to a given frequency of oscillation by the condenser $C-1$ and the plate circuit by condenser $C-2$.

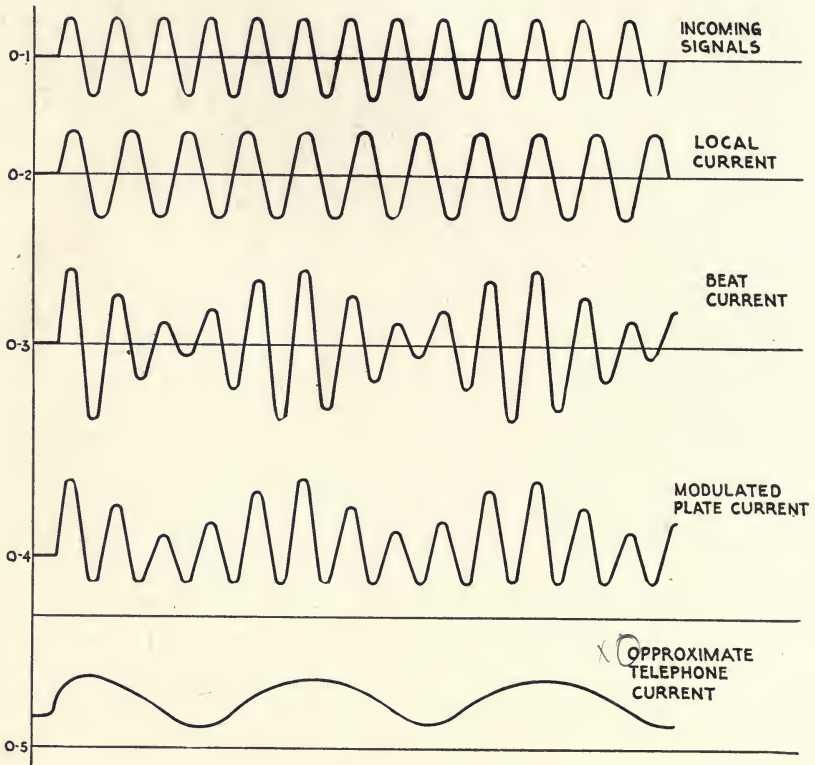

Figure 59

Illustrating the actions of the three-electrode tube for the detection of beat currents.

The conditions present in the plate circuit are substantially those of the circuit, Figure 61, where an oscillation circuit including coil L and condenser C is shunted by the battery B , the circuit being impulsed by opening and closing the switch S .

When the switch S is closed, the energy supplied by the battery is stored temporarily in coil L and condenser C ; but when switch S is opened this stored up energy is released and the circuit L, C , oscillates at a radio frequency determined by the product of the capacity and in-

ductance of the circuit. Now, switch *S* can be considered to be replaced in Figure 60 by the valve grid *G*, which varies the current of *B-2* by change of its potential.

It has been shown that if the grid is charged to a high negative potential, the circuit of *B-2* is completely opened (but this does not occur in practical operation) and consequently, it is easily seen that any vari-

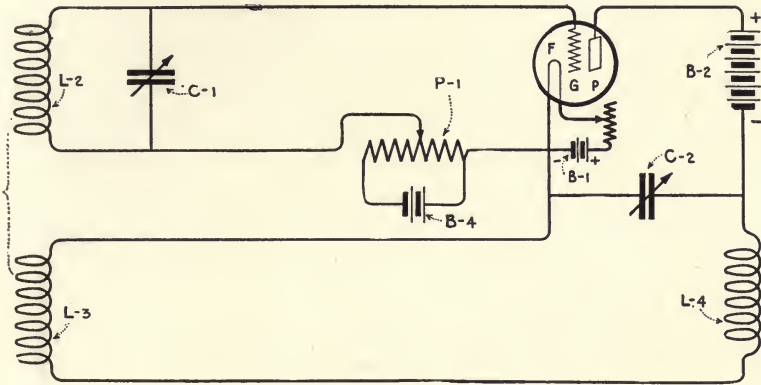

Figure 60

The circuits of the vacuum tube for generating radio frequency currents.*

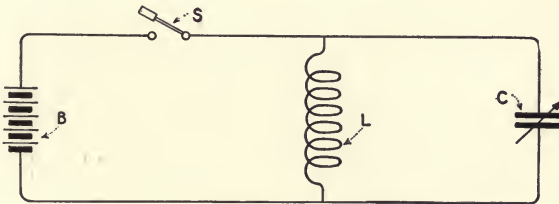

Figure 61

An oscillation circuit set into excitation by an external E. M. F.

able E.M.F. applied to the grid circuit, will vary the strength of the plate current, which will set circuit *L-3*, *C-2*, *L-4* into oscillation at a radio frequency.

Through the coupling *L-2*, *L-3*, the grid circuit *L-2*, *C-1*, will be set into oscillation, and it will vary the plate current through change of the grid potential. This will occur in synchronism with the radio frequency current. In this way the complete system oscillates at a radio frequency which may be varied over a wide range of frequencies by

*The grid battery *B-4* is not essential in this circuit.

change of capacity of condensers $C-1$ and $C-2$, or by variation of inductances $L-2$, $L-3$ and $L-4$. It is found, in practice, that the condenser $C-2$ and the coil $L-4$ can be eliminated, sufficient energy being liberated in the plate circuit to keep the valve circuits in self-oscillation through the coupling coils $L-2$, $L-3$.

It should now be clear that in order to set the valves into self-oscillation, it is necessary to change the potential of either the grid or plate circuits, and to provide *static or magnetic coupling* between the circuits in order that some of the energy released by the plate circuit may be fed back into the system. A switch may be connected in the circuit of the battery $B-4$ to set the system into oscillation. It is frequently found that sudden variations of the capacity of condenser $C-1$, or $C-2$, will vary the potential sufficiently for the purpose.

Connected as in Figure 60 the valve may be employed to generate the local oscillations for the beat system shown in Figure 57. The receiving antenna is coupled to either coil $L-2$ or $L-3$.

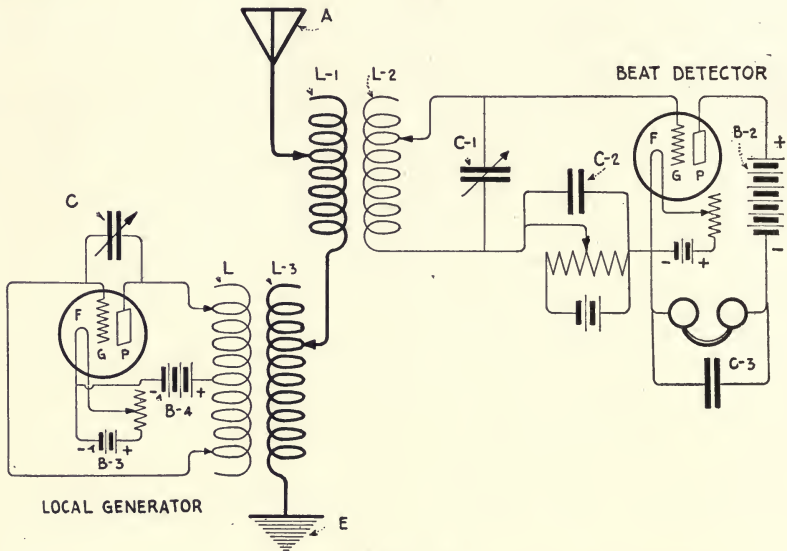

Figure 62

The vacuum tube connected up for generation of radio frequency oscillations for the production of beat currents. This system is sometimes called the external heterodyne.

A simpler valve circuit for the generation of sustained oscillations is shown in Figure 62, where the grid and plate circuits are magnetically coupled through the coil L ; additional regenerative coupling is provided by condenser C . By proper selection of the values of L and C , the valve

circuits will oscillate vigorously at any desired frequency. These oscillations interacting with the oscillations of the incoming signal produce beats in the detector circuits which in turn are detected by the valve acting in either of the ways previously outlined.

42. THE REGENERATIVE BEAT RECEIVER.—In the heterodyne or beat receiver circuits heretofore shown, the local frequency is generated by an *external oscillator*, and the beat currents are detected in a *coupled detector circuit*. Such a receiver may be termed the *external heterodyne*.

We now come to a regenerative receiver in which the combined functions of *regenerative amplification*, the *generation of local oscillations*, the *production of beats* and *detection* occur in the circuits of a single valve bulb. Such a system is generally known as the *regenerative beat receiver*, but is also termed the *self-heterodyne* or *internal heterodyne*.

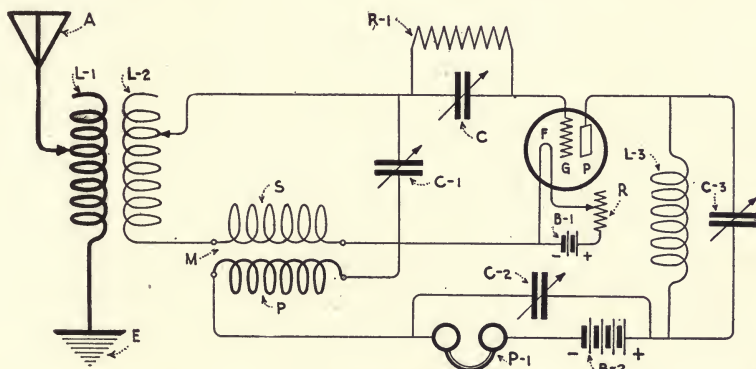

Figure 63

The vacuum tube as a self-heterodyne or as a detector of continuous waves. (Armstrong's Regenerative System).

All of the several regenerative circuits already shown can be set into self oscillation at radio frequencies provided the coupling of the plate and grid circuits is sufficiently close. For example, the circuit shown in Figure 38 and reproduced in Figure 63, indicates a system which will generate undamped or continuous oscillations of any desired frequency, but which simultaneously will act as a detector of incoming radio signals. This is one of Armstrong's original regenerative circuits.

The plate circuit in Figure 63 is tuned to the incoming signal by L-3, C-3, P (C-2 may be fixed), and the grid circuit by L-2, S, C-1. Usually a fixed capacity can be found for condenser C, approximately .00003 microfarad.

(a) **How the Valve is Set into Self-Oscillation.** We have already explained in a general way the process by which the valve may be made to generate radio frequency currents. Imagine any disturbance to occur in the plate circuit such as a sudden variation of the plate voltage—the resulting change of current through P causes it to act inductively on S , setting the grid circuit $L-2$, $C-1$, S , into oscillation. The grid then acts to vary the plate current at a radio frequency. Part of the plate circuit's energy is fed back to the grid circuit to keep the entire system in self oscillation. This state of oscillation is only possible by reason of the fact that the energy released in the plate circuit is equal to, or exceeds that applied to the grid circuit, and consequently part of the energy liberated by the plate circuit can be re-transferred to the grid circuit through the regenerative coupling to keep the system in continuous oscillation.

The frequency of the oscillations generated by the valve of Figure 63, will be approximately that of the grid circuit, if the capacity of the secondary condenser exceeds the capacity of the valve (grid to filament), but if it is less than the valve capacity, the inductance and capacity of the plate circuit will be the governing factor.

(b) **The Phenomena of the Self-Heterodyne.** The sequence of events when the valve of Figure 63 is set into self oscillation, has been explained graphically by Armstrong as in the curves of Figure 64, where graph $O-1$ shows the gradual building up of oscillations in the grid circuit by regenerative coupling. These oscillations are rectified and charge the grid condenser C , the charge in which leaks off constantly either through the valve or across a special leak resistance ($R-1$, Figure 63) of several hundred thousand ohms.

Now, the rectified current charges the grid negatively and, as already explained, an increasing negative charge decreases the plate current and consequently reduces the amplitude of the grid circuit oscillations—less energy being supplied through the regenerative coupling M . This reduction continues until the amount of electricity supplied to the grid condenser is equal to the rate at which it leaks off.

The valve then oscillates steadily as shown by the curve $O-2$, which represents the potential of the grid to filament. The plate current undergoes variation at the same frequency as shown by $O-3$. The steady telephone current is shown by the curve $O-4$.

Let the valve circuits oscillate steadily as shown in the curves $O-2$ and $O-3$, and let the frequency differ slightly from that of the incoming signal; independently of the local oscillations the incoming oscillations change the grid potential, are repeated in the plate circuit and are re-

enforced in the grid circuit through the regenerative coupling M (Figure 63). Simultaneously these amplified oscillations interact with the local oscillations producing throughout the system the *beats* shown by line $O-1$ (Figure 65).

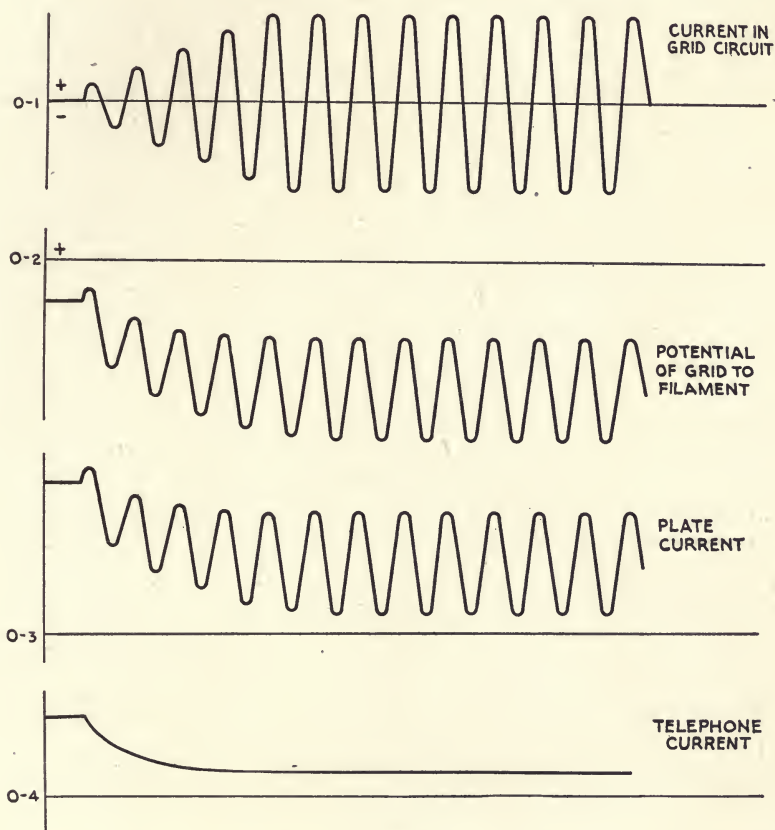

Figure 64

Showing the phenomena involved when the vacuum tube of figure 63 is set into self-oscillation.

These beats alternately increase or decrease the potential of the grid above and below that steady state indicated at $O-2$ in Figure 64. Hence, the *potential of the grid to the filament* varies as in curve $O-2$, Figure 65, and the *plate current fluctuates* at an audio frequency as in $O-3$; that is, the amplitude of the repeated radio frequency plate current varies at an audio frequency, and the approximate *telephone current* is that shown in the curve $O-4$ (Figure 65).

As pointed out by Captain Armstrong, the great advantage of this

system of reception lies in the fact that the telephones are traversed by an almost *simple harmonic alternating current*. Hence, the telephone receivers may be connected in a coupled *audio frequency tuning circuit* where *selectivity* or *tuning* independent of the *signalling frequency* may

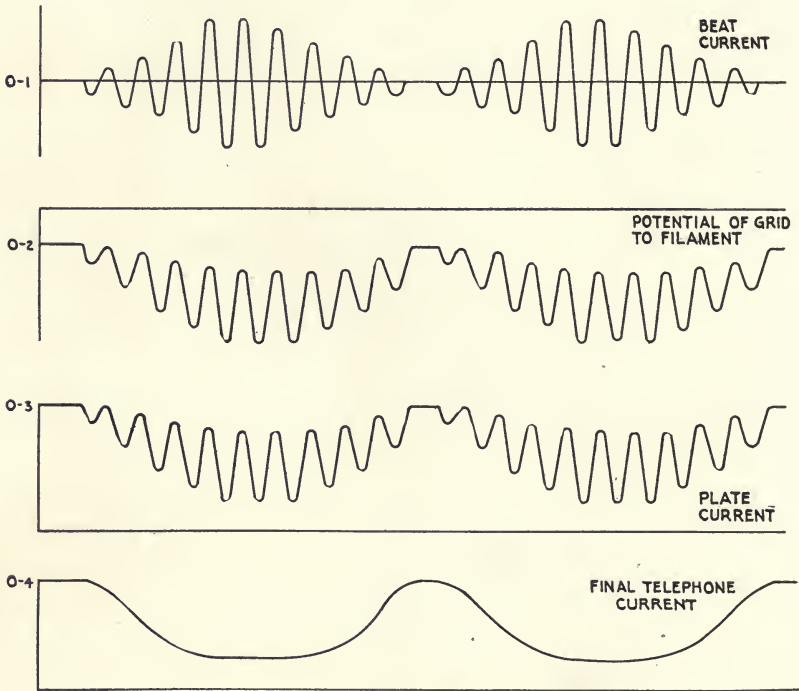

Figure 65

Illustrating the resulting beat currents and the final effect upon the telephone current of the vacuum tube, connected as in figure 63.

be secured; that is, an *audio frequency tuning circuit* may be coupled to the output circuit of the valve, in which oscillations of different *group frequencies* can be *tuned in or out* as desired.

43. AUDIO FREQUENCY TUNING.—In the circuit for *group frequency* (audio frequency) *tuning* shown in Figure 66, the primary and secondary circuits of the receiving transformer have been eliminated; connection in practice being made to terminals *A, B*. The group frequency tuner embraces the telephone *P*, the variable condenser *C*, and the secondary winding *S'* which is coupled to the plate circuit of the vacuum valve through winding *P'*, shunted by condenser *C-2*.

In order to secure effective *group tuning* the inductance of the coil

S must be extremely large to obtain the necessary ratio of reactance of the circuit.

The use of this circuit in practice may be explained as follows: Assume that during the reception of undamped waves, several beat fre-

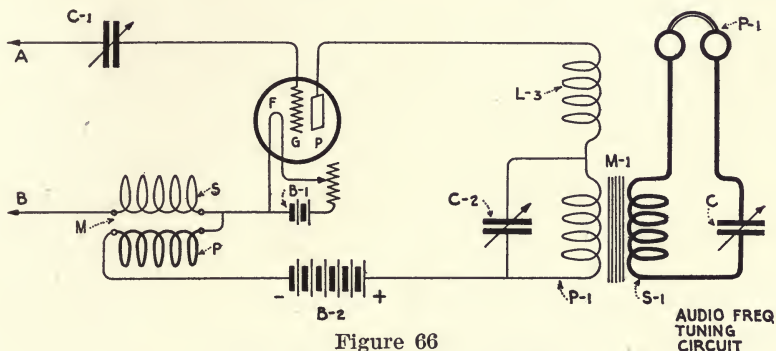

Figure 66
Audio frequency tuning circuit.

quencies are obtained in the plate circuit of the vacuum tube; the receiving operator may obtain response from the signal desired by carefully tuning the audio frequency circuit to a particular beat pitch to the complete or partial exclusion of the unwanted signals. Selectivity is thus secured independently of the usual radio frequency tuning.

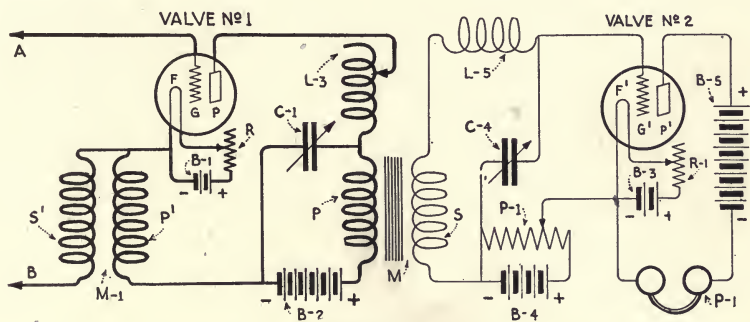

Figure 67
Two-step vacuum tube cascade amplifier. The grid circuit of the amplifying tube is tuned to audio frequencies.

A more desirable circuit for audio frequency tuning is shown in Figure 67, where a second vacuum valve with a *tuned audio frequency grid circuit* $S, L-5, C-4$, is coupled to the plate circuit of the first valve through the audio frequency transformer M . By keeping the resistance of this circuit low, response may be obtained in the output circuit of the second valve at audio frequencies with much lower values

of inductance in the grid circuit than those employed in the audio frequency tuning circuit of Figure 66.

In the diagram, Figure 67, S , $L-5$, $C-4$, are of the correct value to permit tuning to frequencies from say 200 to 1,000 cycles per second. By means of battery $B-4$, and potentiometer $P-1$, the potential of the grid in respect to the filament in the second valve is adjusted to obtain the best amplification. The condenser $C-1$ in the plate circuit of the first valve serves as a by-pass for the radio frequency component of the plate current around the audio frequency inductance P . Coil $L-3$ permits the plate circuit of the first valve to be tuned to the incoming signals, and regenerative coupling as usual is obtained at the radio frequency transformer $M-1$.

In order that full advantage may be taken of an audio frequency tuning circuit, it is essential that the frequency of the wave generator remain constant, for it is readily seen that if its frequency changes, the beat note will change at the receiver. This may put the beat frequency out of range with the sharply tuned audio-frequency circuit.

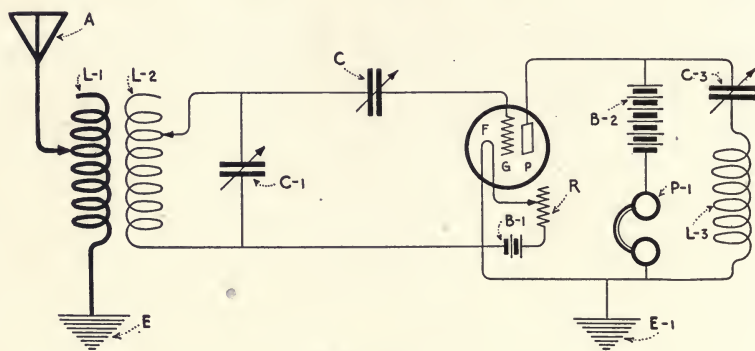

Figure 68

Weagant's receiver for damped and undamped oscillations.

A phenomenon of this circuit which causes it to operate at a disadvantage is the following: An impulse of static or atmospheric electricity will set the audio frequency circuit into oscillation by shock excitation converting the otherwise low-pitched static signals into musical sounds.

In event that static is not severe and interference is experienced from another station, some advantage is derived in the use of this circuit.

44. THE WEAGANT UNDAMPED WAVE RECEIVER.—

Regenerative couplings such as previously shown are not essential to the production of beat currents in the reception of continuous waves. The system of Figure 68, devised by Mr. Roy A. Weagant, functions

satisfactorily with the simple set of connections shown. The principle feature of this system is the "X," or tertiary circuit, consisting of the condenser *C-3* and the inductance *L-3*, which are connected in series, and in shunt to the plate circuit.

By carefully adjusting the capacity of the condensers in the secondary and "X" circuits, or change of both the inductance and capacity, the system will oscillate at radio frequency which may be made to differ slightly from the frequency of the incoming signal. Beats of any desired frequency are thus formed.

In practice, the author has found this system to give practically the same strength of signal as any of the regenerative circuits previously shown. It is applicable either to damped or undamped oscillations. On account of its extreme simplicity the circuit is particularly recommended.

45. MODIFIED WEAGANT BEAT RECEIVER.—The circuits of Figure 68 may be modified as in Figure 69. It is simply an extension of the "X" circuit, inductive regenerative coupling being secured through the coupling *L-4*, *L-5*.

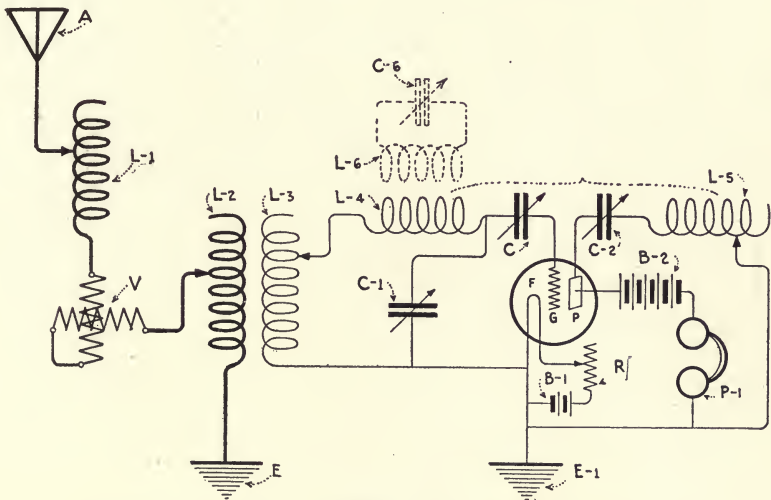

Figure 69

Modified Weagant receiver for continuous and discontinuous waves.

In Figure 69, the aerial tuning inductance is indicated at *L-1*, the primary winding of the receiving tuner at *L-2*, the secondary winding at *L-3*, the secondary loading inductance at *L-4*, and the shunt secondary condenser at *C-1*. The usual grid condenser is indicated at *C* and the

tuning elements of the plate circuit at $L-5$, $C-2$. $L-4$ and $L-5$ are placed in inductive relation for regenerative amplification.

It is preferable in a circuit of this kind that the secondary inductance $L-4$ be connected at the upper end of the coil $L-3$ as indicated in the drawing, since the valve functions best in a secondary circuit giving the maximum possible voltage for a given incoming signal. The point of maximum potential in this case is at the right-hand end of the coil $L-4$; that is, the greatest E.M.F. exists at the end of $L-4$ furthest away from the earth end of $L-3$.

In the reception of undamped waves the operator adjusts the apparatus first by regulating the incandescence of lamp filament and the voltage of the battery $B-2$. He then tunes the grid and plate circuits to the requisite frequency for the production of beat currents. The stability of the circuit with some valves is somewhat enhanced by adjusting the coupling between $L-4$ and $L-5$, but it is not essential to practical operation in the majority of cases.

The inductance of $L-4$ and $L-5$ may be fixed. A wide range of frequencies may be secured by simultaneous adjustment of the variable condensers $C-1$ and $C-2$.

The antenna must, of course, be tuned to the incoming signal by inductances $L-1$ and $L-2$, or at the variometer V , but in general, these three adjustments cover substantially all operations necessary in practice to tune the circuits to the distant transmitter.

Inductive disturbances from nearby 60 cycle alternating current circuits may be eliminated by connecting the valve filament to earth at point $E-1$.

For wave lengths up to 10,000 meters, coils $L-4$ and $L-5$ if of the single layer type are from 20 to 24 inches in length and from 5 to 6 inches in diameter wound with No. 30 or 32 B. & S. wire. The author, in fact, has secured very good results with much smaller coils wound with No. 36 B. & S. wire. *Multi-layered* coils are frequently used in circuits of this kind, and of course possess smaller dimensions for a given wave length than any of the other types mentioned. The receiving transformer $L-2$, $L-3$ for use in connection with the loading coils mentioned above may have the usual dimensions for wave lengths up to 4,000 meters.

A *variometer inductance* is of considerable advantage in the beat receiver circuits.

The effect of turning the handle of the variometer during beat reception from a continuous wave transmitter is of interest. Assume that with the control handle at the "half-way" position a beat note equal to a pitch of 500 is secured in the head telephones, then by simply turning

the handle (of the variometer) thereby detuning the antenna circuit, the pitch of the beat note will change from a higher to a lower note accordingly as the tuning is varied.

As a matter of scientific interest, there has been included in dotted lines in the diagram of Figure 69, a so-called "*sensitizing*" circuit, *L-6, C-6*, first published by Dr. Austin.

It has been assumed by Dr. Austin that the coupling of this circuit to the secondary system merely reduced the amplitude of the locally generated oscillations, and since some optimum value* of the locally generated current in the heterodyne system gives the best amplification, this was asserted to be the effect of the sensitizing circuit.

According to Captain Armstrong, the key-note to the phenomenon is that coupling the circuit *L-6, C-6*, to the secondary circuit gives this system two natural frequencies of oscillation differing by 500 to 1,500 cycles per second, one of which coincides with the incoming signal and the other with the locally generated radio frequency current.

That this circuit will amplify the incoming signals is now clear. If the valve is generating oscillations and the frequency of the *antenna, grid, and plate circuits is adjusted* for the production of beats, these circuits are slightly *out of resonance with the incoming signal* and therefore offer some reactance; but when the grid circuit possesses two degrees of freedom, one of these can be the frequency of the incoming signal and the other the frequency of the locally generated current. Hence, the circuits possess *zero reactance* to either the local frequency or the signalling frequency which permits either current to rise in amplitude. The same effect can be secured by *close coupling of the open and closed circuits*. But with the sensitizing circuit a smaller degree of coupling can be employed between the open and closed circuits with the same strength of signals, permitting greater freedom from interference.

46. RECEPTION OF CONTINUOUS WAVES BY THE VALVE WITHOUT BEATS.—We are indebted to Captain Armstrong for the disclosure of a circuit for the reception of continuous waves, which employs the generating feature of the vacuum valve, but *does not make use of the beat phenomenon*. The circuits appear in Figure 70.

The incoming oscillations, which, of course, are of continuous amplitude, are varied at an audio frequency by setting the first valve into *self-oscillation at an audio frequency*. Meanwhile, incoming radio frequency currents are repeated into the plate circuit of the first valve and

*See paragraph 52.

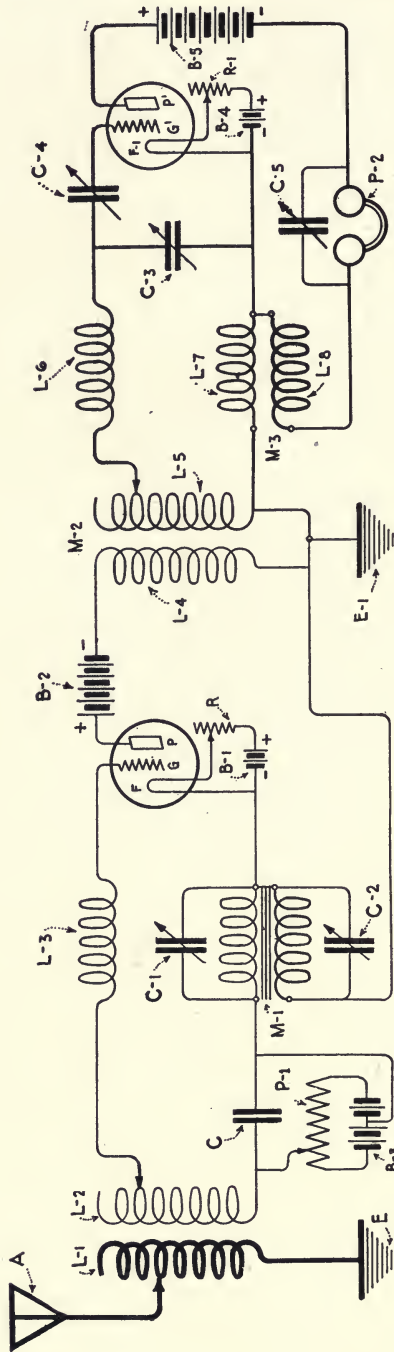

Figure 70

Vacuum tube circuit suitable for reception of continuous oscillations without the production of beats.

are amplified by the second valve through regenerative coupling, but their amplitude is modulated at an audio frequency by the first valve. Hence, groups of radio frequency oscillations flow in the grid circuit of the second valve where rectification takes place as usual.

It is to be observed that the grid potential of valve No. 1 is regulated by battery *B-3* and potentiometer *P-1*. The plate and grid circuits are coupled through an audio frequency transformer *M-1*, the primary and secondary coils of which are tuned by condensers *C-2* and *C-1* respectively. The radio frequency component of the plate current of the first valve is impressed upon the grid of the second valve through the plate inductance *L-4*.

Tracing the connections further, the second valve is equipped with a radio frequency regenerative transformer *M-3* (which amplifies the incoming signal), and the *complete grid circuit* includes the inductances *L-5*, *L-6*, and *L-7* and variable condenser *C-3*. A path for the radio frequency current flowing in the output circuit around the telephone of the second valve is provided by condenser *C-5*.

The processes involved in the detection of undamped oscillations by the circuit of Figure 70 follow: the first valve is set into oscillation at an *audio frequency* through the coupling *M-1*, so that if a telephone were inserted in the plate circuit of *B-2*, a continuous tone would be heard in the telephone receiver. Simultaneously the incoming oscillations impressed upon the grid circuit of the first valve are repeated into its plate or output circuit and thence impressed upon the grid or input circuit of the second valve through coils *L-4* and *L-5*, wherein amplification and detection takes place in the usual manner; that is, the amplitudes of the incoming radio frequency oscillations are varied at an audio frequency, and therefore the potential of the grid varies in accordance.

The foregoing actions are shown graphically in Figure 71, where the oscillations of the *incoming signals* are indicated on the line *O-1*, the *modulated radio frequency currents* by the line *O-2*, the *grid oscillations* of the second valve by the line *O-3*, and the *current in the output or telephone circuit* of the second valve by the line *O-4*.

In practical operation it is essential that the coupling of the radio frequency transformer *M-2* be carefully adjusted, for otherwise the audio frequency component of the plate circuit of the first valve will be heard as a musical tone in the telephone of the second valve.

The primary and secondary coils of transformer *M-2* are connected to earth. This prevents electrostatic coupling between the windings *L-4* and *L-5* through the telephone of the second valve to earth.

A simple buzzer placed in inductive relation to circuits of the first

valve obviously would give approximately the same results as this circuit. The audio frequency coupling then may be eliminated.

47. CASCADE AMPLIFICATION.—The output circuits of any of the foregoing types of beat receivers can be connected to a battery of vacuum valves in cascade for further amplification of the incoming signal. Either the *radio or audio frequency component may be ampli-*

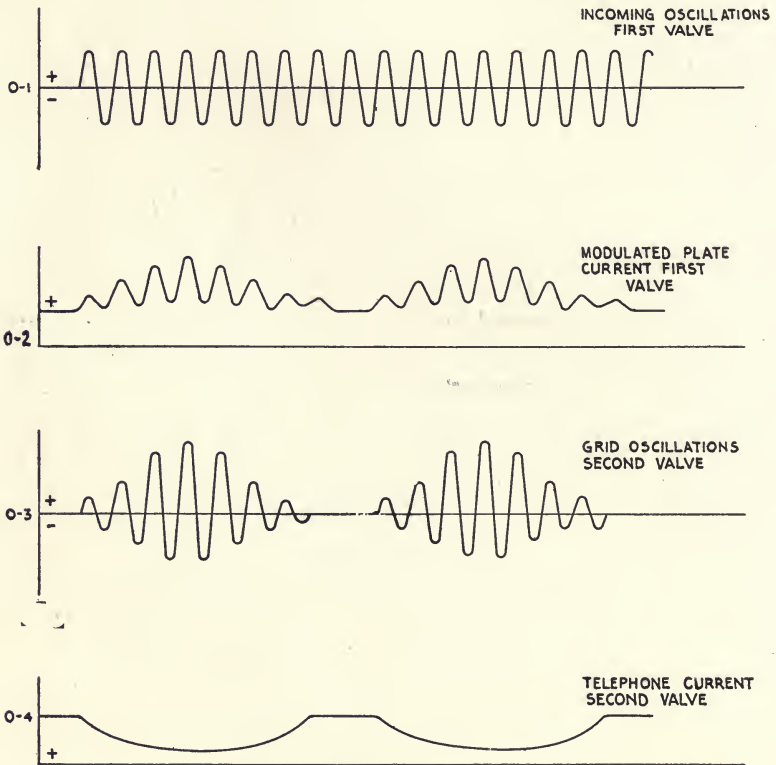

Figure 71

Indicating the phenomena involved in the operation of the apparatus in Figure 70.

fied. Cascade operation always becomes necessary when the incoming signals are too weak to effect the head telephone. The student who has carefully studied previous chapters describing the various cascade circuits will be able to devise various amplification circuits.

Better results are obtained under the usual operating conditions, by connecting the valves for radio frequency amplification. In addition to the increased strength of signals resulting therefrom, increased selec-

tivity is obtained, that is to say, the additional energy released in successive circuits in the form of radio frequency oscillations causes these circuits to function with reduced damping. Captain Armstrong declares that two vacuum valves connected in cascade for radio frequency amplification will increase the incoming signals 1,000 times.

48 CASCADE REGENERATIVE SYSTEMS FOR BEAT RECEPTION.—If the incoming signals are too weak to give response in the plate circuit of a single wave, progressive amplification can be secured by combining the regenerative and cascade systems. Such systems may be employed for reception of *continuous* or *discontinuous waves*.

In systems of this kind either one bulb is employed to amplify and repeat the incoming signal into a second bulb, the latter being set into oscillation for the production of beats, or the circuits of both bulbs may be set into oscillation. *Beats then will be generated throughout the entire system;* but in general, it is somewhat difficult to keep the two circuits oscillating in synchronism.

If the two bulbs oscillate out of synchronism or assynchronously, a beat note is obtained causing a continual hum in the receivers,* but by carefully adjusting the radio frequency tuning of one of the valves the beats can be brought into synchronism at a frequency near to 200 cycles per second as is evidenced by silence in the head telephones. Various combination circuits are possible. One circuit is shown in Figure 72. In this system, amplification in the first valve is obtained as usual:

- (1) By tuning the grid and plate circuits of the first valve;
- (2) By carefully adjusting the coupling of the regenerative transformer M-1 for maximum amplification;
- (3) By adjusting the grid potential through battery B-3 and the grid potentiometer P-1.

The principal adjustments for radio frequency tuning in the first valve are made at:

- (1) Antenna inductance L-1;
- (2) Secondary loading inductance L-3;
- (3) Secondary condenser C-1;
- (4) Plate circuit condenser C-2.

Similarly, for the radio frequency circuits of the second valve at:

- (1) Secondary loading inductance L-5;
- (2) Secondary condenser C-5;
- (3) Plate circuit condenser C-6;
- (4) Plate inductance L-4.

*A weak beat note is not harmful to reception.

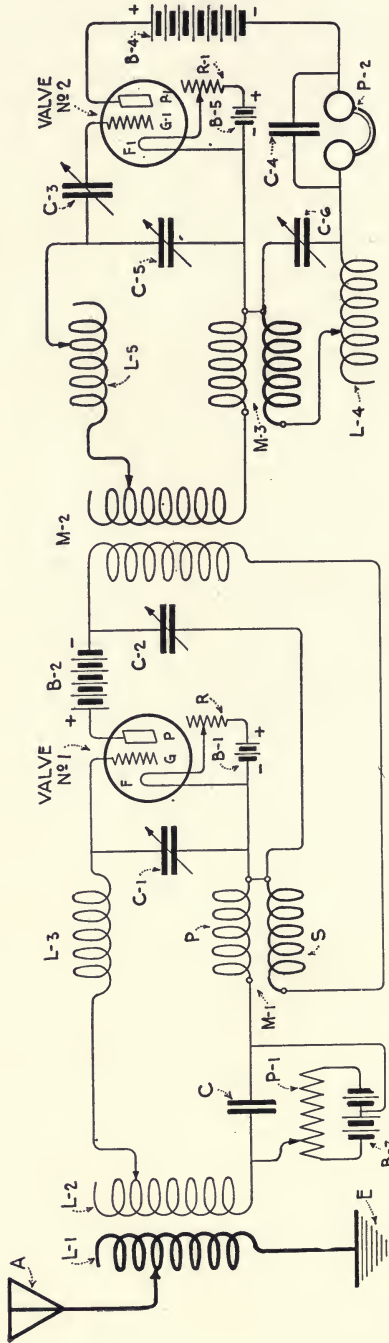

Figure 72

Combined regenerative and cascade systems for the reception of continuous waves. Either valve No. 1 or valve No. 2 is set into self-oscillation for the production of beats or by careful adjustment both valves may oscillate in synchronism at a radio frequency setting up beats throughout the entire system.

The coupling of the regenerative transformer $M-1$ should be just close enough to amplify the incoming radio frequency signals. The amplified radio frequency component of the plate current is then impressed upon the grid circuit of the second valve which already has been set into oscillation at a frequency slightly different than that of the incoming signal.

Beats are then generated in the second system which are rectified as usual, alternating current of an audio frequency flowing through the head telephone $P-2$. Careful adjustment of couplings $M-1$, $M-2$ and $M-3$ is essential for stable operation.

It may be mentioned here, that the primary secondary coils of the regenerative transformers generally possess fixed values of inductance. Any radio frequency tuning which may be necessary in either circuit is secured through additional variable inductances or condensers.

It tends toward simplicity of operation in cascade systems to eliminate the two regenerative couplings of Figure 72, employing instead the simple cascade radio frequency amplifiers shown in Figure 73.

The last valve of the group may, or may not be fitted with a regenerative coupling $M-3$,* for as has already been set forth, the valve circuits may oscillate at a radio frequency without regenerative coupling.

In Figure 73, $L-2$, $L-11$, $C-1$ constitute the radio frequency tuning elements of the grid circuit for the first valve; $L-3$, $C-2$ for the plate circuit; $L-4$, $L-12$, $C-3$ for the grid circuit of the second valve; $L-5$, $C-4$ for the plate circuit of the second valve; $L-6$, $L-7$, $L-8$, $C-5$ for the grid circuit of the third valve; and $C-6$, $C-7$, $L-9$ and $L-10$ for the plate circuit of the third valve. Battery $B-3$ and potentiometer $P-1$ are employed to adjust the grid potential of the first valve; similarly $B-5$ and $P-2$ for the second valve. The audio frequency reduction and increase of the plate current of the third valve is secured by the grid condenser C which traps the rectified beat currents, producing a relaying action on the plate current.

It will be seen by careful consideration of the circuits in Figure 73 that the amplified radio frequency component of the plate current of the first valve is impressed upon the grid circuit of the second valve through the radio transformer $M-1$; similarly, the amplified radio frequency component of the plate current of the second valve upon the grid of the third valve by $M-2$.

The circuits of the third valve are set into *self-oscillation* at a *slightly different frequency* than that of the incoming signal so that the interaction of the two currents produces *beats* which are rectified and

*See paragraph 44.

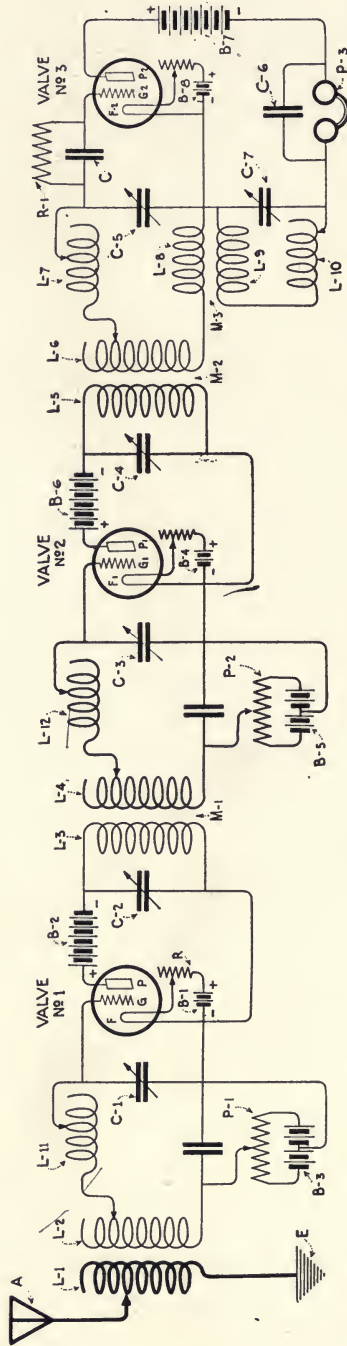

Figure 73

Showing the circuits of a cascade amplifying system for the reception of continuous oscillations, wherein regenerative couplings are dispensed with except in the last tube.

trapped in the grid condenser C . The tuning condensers across the primary coils of $M-1$ and $M-2$ can be eliminated, sufficient response generally being secured with untuned circuits.

As usual a special resistance $R-1$ provides the requisite leakage for the grid condenser.

It here should be borne in mind that coupling two valves in the manner shown results in the withdrawal of energy from the plate circuits of the first valve, and some readjustments of the circuit are then required for maximum response. Such adjustments are most readily determined by experiment.

49. BEAT RECEPTION FROM DAMPED WAVE TRANSMITTERS.—Partial beats are formed when locally generated oscillations interact with discontinuous or damped oscillations such as those generated by spark transmitters. Due to the discontinuity of the radiated waves complete beat formations such as are obtained from continuous waves cannot be had. Nevertheless, amplification results, but a *distorted note* is obtained in the receiving telephone, that is, the normal note of the spark transmitter is destroyed and a beat note of a rough quality is obtained.

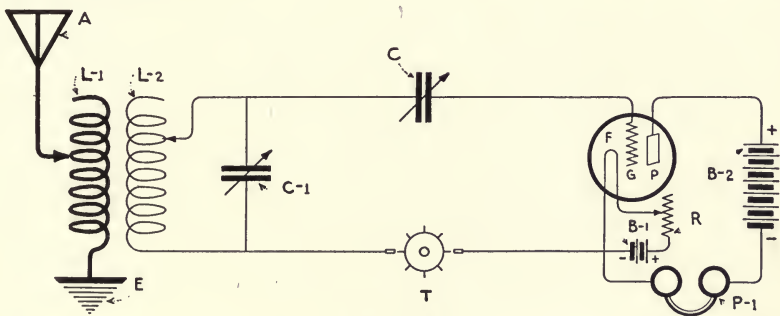

Figure 74

Showing the use of a simple "tikker" in the vacuum tube circuits.

In the reception of damped oscillations (or discontinuous waves) through a receiver responsive to either type of oscillations the distortions due to beat formations can be prevented by careful adjustment of the coupling of the regenerative transformer. The coupling should be close enough to reinforce the plate oscillations through the grid circuit but *not* to set the valve into self-oscillation.

50. SPECIAL CIRCUITS FOR THE VACUUM VALVE.—

It is now obvious that the vacuum tube can be employed to amplify the local currents of any type of radio detector. An exemplary circuit is shown in Figure 74, in which the incoming oscillations are interrupted

at an audio frequency by the motor-driven circuit interrupter or tikker *T*. In this way the amplitude of the otherwise continuous oscillations impressed upon the grid circuit is varied periodically and the grid condenser may therefore be energized at an audio frequency. In other words a system for the detection of undamped oscillations is here provided that does not employ regenerative coupling or the heterodyne principle.

If further amplification is required, a number of valves may be connected in cascade for *radio frequency* or *audio frequency* amplification.

The disadvantage of the connection shown in Figure 74, is that the tikker interrupts the conduction current from the grid to filament, causing a humming sound in the telephone independently of the incoming signal. But this may be prevented by placing the tikker in the antenna circuit or in a special circuit to which the valve is coupled inductively.

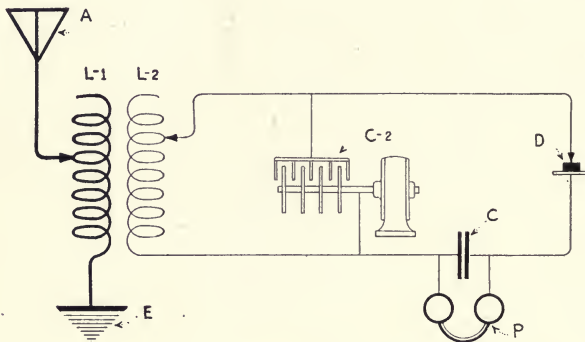

Figure 75

Illustrating the use of the revolving variable condenser for making audible undamped oscillations.

(a) **The Use of a Rotary Condenser for the Reception of Continuous Oscillations.**—The author has recently taken out a patent on a receiver for continuous wave reception, the fundamental characteristics of which are shown in Figure 75.

A revolving secondary condenser *C-2* constructed much like a rotary spark gap is connected in shunt to the secondary coil of the receiving transformer *L-2*. This condenser contains twelve sets of stationary plates mounted in a circle and one movable set driven by a high-speed A.C. or D.C. motor. Now, if the primary and secondary circuits of Figure 75 are tuned to a continuous wave transmitter without the revolving condenser *C-2*, direct current will pass through the telephone *P*;

but for reasons explained in paragraph 1, the telephone diaphragm will emit no sound. If the condenser rotates at such speeds to throw the secondary system into and out of resonance 200 to 1000 times per second, the amplitude of the telephone current will be varied at the same rate. Hence, groups of direct current pulses occurring at an audio frequency will flow through the head telephone *P*.

The advantage of this method over the usual tikker is obvious; all electrical contacts are done away with and beyond this, the condenser may be inserted in the plate or grid circuit of the vacuum valve without actual interruption of the local currents which would produce a humming sound in the telephone.

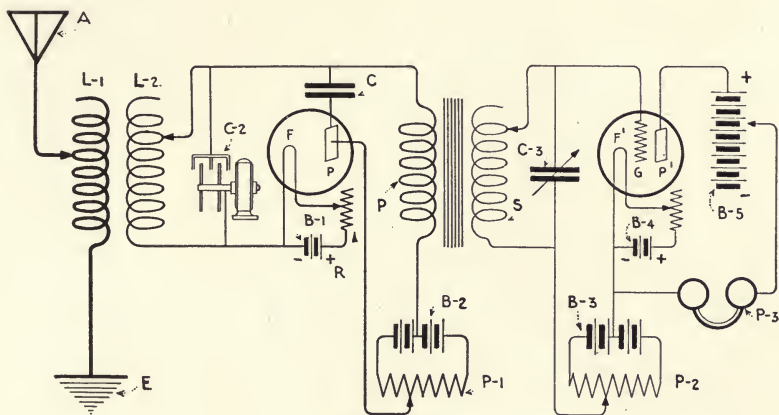

Figure 76

Special circuit for the revolving condenser in connection with the reception of continuous oscillations.

The author has had some success with the connections disclosed in Figure 76, where the amplitudes of the incoming oscillations are varied as in the previous system by the rotating condenser *C-2* and the resulting groups of radio frequency currents rectified by the two electrode valve, *F, P*. They are thereafter amplified by a three electrode valve *F', G', P'*, the grid circuit of which is tuned to an audio frequency by the shunt condenser *C-3*.

The two electrode valve is adjusted to the most favorable working point on the characteristic curve by the battery *B-2* and the potentiometer *P-1*, the potential of *B-2* varying from 20 to 100 volts. Groups of rectified currents flow through winding *P* of an iron core transformer which acts inductively upon the secondary winding *S*. Through potentiometer *P-2* and battery *B-3*, the potential of the grid to filament of the three electrode valve may be adjusted for the best amplification. Further

amplification may be secured by connecting in cascade several valves with iron core transformers inserted between the output and input circuits of successive tubes. The revolving condenser $C-2$ obviously can be placed in any part of the radio frequency circuits of Figure 76.

A point to be considered in the operation of this system is that the condenser must be constructed so that its capacity as the plates revolve covers a small range, for otherwise, signals from undesired stations will be tuned to resonance if the coupling $L-1$, $L-2$ is close. In addition care must be taken to select the proper values of inductance at $L-2$, so that the secondary system is thrown into resonance at the point where the revolving condenser reaches its maximum capacity; for, otherwise, the circuit will be thrown in and out of resonance twice for each set of stationary plates, and a rather mixed note in the telephone will result.

51. "OPEN CIRCUIT" OSCILLATORS FOR THE VACUUM VALVE.—The operating characteristic for the three-electrode valve, shown in Figure 22, indicates that the strength of the plate current at certain points along the characteristic curve varies directly with the grid potential. Hence, if the valve be employed as an oscillation detector, the best response will be obtained from a circuit which provides the maximum E.M.F. for a given group of oscillations. This condition is satisfied by making the inductance of the grid circuit very large and the shunt condenser very small for a given frequency or wave length. In general, the capacity of the shunt condenser should not exceed say .0005 microfarad.

Over the range of the shorter wave lengths, the secondary condenser may be dispensed with, the distributed capacity of the secondary inductance and the internal capacity of the vacuum valve (filament to grid) completing the oscillation circuit.

At the longer wave lengths the capacity of the grid circuit inductance becomes so high in comparison with the valve capacity that better signals are secured by employing a secondary condenser to fix definitely the maximum and minimum potential across the filament and the grid.

Because of the high potential which exists on the free end of an *open circuit* or linear oscillator, a coil of high self-inductance may be employed in the grid circuit of the vacuum tube to amplify the signal. One circuit of this kind devised by the author several years ago, is shown in Figure 77, where the usual antenna inductance is indicated at $L-1$, an *open circuit* or *grid circuit* coil at $L-2$ being placed in inductive relation thereto and connected to earth at the lower end. The free end of $L-2$ connects through the grid condenser C to the grid G of the valve. In event that the length of the coil $L-2$ is excessive for maximum amplifi-

ation, it may be reduced and shunted by a variable condenser. A unipolar connection of the valve, however, is still used as shown in Figure 77.

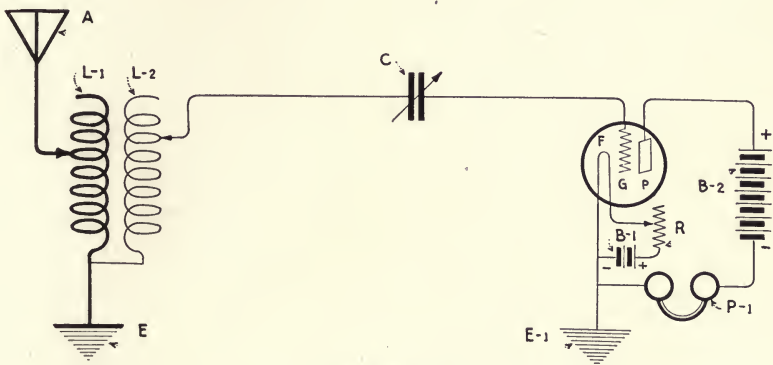

Figure 77

Open circuit oscillator for the reception of damped or undamped oscillations.

As already remarked, amplification is obtained in this circuit by reason of the increased potential impressed upon the grid, but with very long coils, the resistance losses and absorption through the self-capacity of the coil may be excessive and the selectivity thus afforded may not equal that of a smaller coil with a shunt condenser. The coil $L-2$ obviously must be of considerable length for the longer wave lengths.

The natural frequency or wave length of open circuit coils can be measured by placing a wave meter set into excitation by a buzzer in inductive relation to the coil, the free end of which terminates in a crystal rectifier shunted by a head telephone.

The best results are secured with this system when $L-2$ is of *different dimensions* for each wave length. In other words, elimination of the unused turns is desirable. An *end turn switch* might be employed to break the winding into groups for different frequencies. Such a switch, however, does not eliminate wholly the end turn losses, but it aids in this direction. For complete removal of these effects the unused turns must be removed from the magnetic field of the used turns.

Coil $L-2$ need not necessarily be connected to earth at the lower end. It may be left ungrounded, but it must then possess a considerably greater number of turns for a given wave length, than when connected to earth. Its natural frequency of oscillation must equal that of the incoming signal.

Induction from low frequency power circuits is prevented by connecting one leg of the filament of the valve to earth. The earth con-

nection is not essential to the radio frequency tuning of the secondary or grid circuit, but it assists in eliminating local inductive disturbances.

(a) **Modified Open Circuit Oscillators.**—Numerous modifications of the circuit shown in Figure 77 are possible. For example, in Figure 78 the valve is connected to the free end of an aerial A, B , which is con-

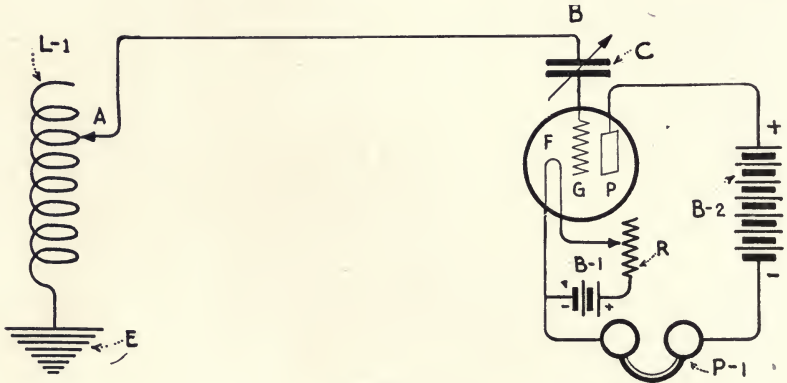

Figure 78

Novel connection of the three-electrode valve. The grid is connected to the free end of a flat top aerial.

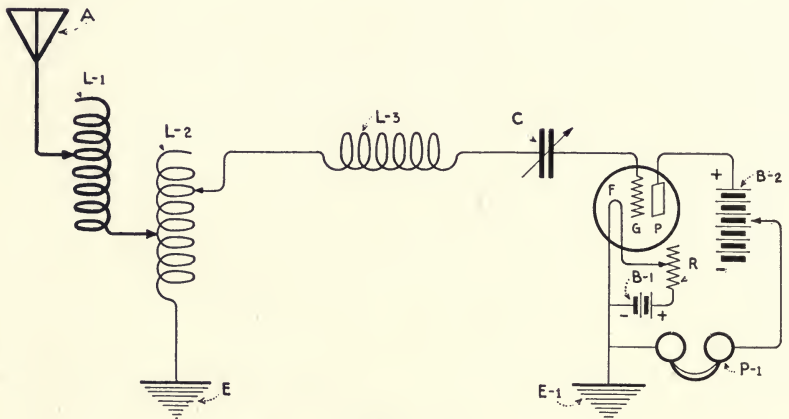

Figure 79

Showing the use of open circuit oscillators with direct coupling between the antenna and grid circuits.

nected to earth through the tuning inductance $L-1$. By variation of $L-1$, the maximum potential may be made to occur at the free end of the aerial, which is attached to the grid G . Amplification is thus secured.

A circuit much similar to Figure 77, preferred by the author is shown in Figure 79, where the primary and secondary circuits of the

receiving system are directly coupled and the grid G connected to the free end of an open circuit oscillator, $L-3$. Circuit $L-2$, $L-3$, C , G , is tuned to the frequency of the incoming signal and a very high potential is impressed upon the grid. The filament F , as usual, is connected to earth at $E-1$. Regenerative couplings may be employed in the circuits of Figures 77, 78, or 79, the plate circuit being coupled to the grid circuit at $L-3$, $L-4$, as shown in Figure 80. The plate circuit is tuned to resonance with the incoming signal through inductance $L-4$ and condenser

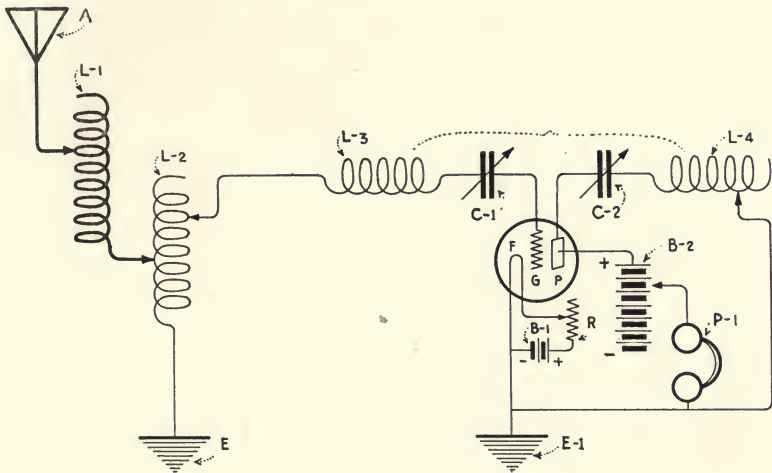

Figure 80

Modified circuits of Weagant's system for the reception of damped or undamped oscillations. The plate circuit is tuned by the inductance $L-4$ and the condenser $C-2$. The grid is attached to the free end of an open circuit oscillator.

$C-2$ which constitute the "X" circuit first disclosed by R. Weagant. This circuit, however, will respond to continuous waves *without the regenerative coupling*, $L-3$, $L-4$. (See paragraph 44.)

52. AMPLIFICATION BY THE HETERODYNE SYSTEM.—

The numerical degree of amplification obtained by the heterodyne receiving system in radio has been a point of considerable debate among wireless engineers. Various figures have been claimed varying from a minimum of four to several thousand. It has been shown mathematically by Liebowitz that the maximum true amplification that may be secured by the *external heterodyne* is four, and that any increase in strength of signals beyond four-fold amplification is due to some increase of efficiency of the detector. It is well known, however, that remarkable amplifications are secured by employing the vacuum valve detector as a *self-heterodyne*.

In fact, the total amplification as actually measured has totaled *several thousand*.

In the self-heterodyne circuits of the regenerative type where the combined functions of *detection, amplification, and generation of the local radio frequency oscillations* occur in the circuits of a single bulb, there are *two methods of amplification* which take place simultaneously, each one operating its own particular way practically independent of the presence of the other.

With the point in view of separating the magnitude of the various amplifying effects produced by the *self-heterodyne* as compared with the *simple vacuum valve* without regenerative circuits, a series of tests was carried out by Captain Armstrong at a wave length of approximately 8,000 meters.*

The first measurements were for the purpose of comparing the signal strength obtained with a simple three-electrode valve coupled to an antenna circuit which was interrupted approximately 600 times per second by a tikker or chopper, and the signal strength secured by what Armstrong terms the "*equal heterodyne*." This is the term he applies to the condition where the locally generated current and the signalling current are equal in strength. It was found in general that the *equal heterodyne* system gave a signal from *four to ten times* as loud as that given by the tikker, the greatest amplification being secured on the weaker signals.

In the second series of tests, the locally generated radio frequency current was increased to the point of maximum amplification and as a matter of notation, this system was termed the "*optimum heterodyne*." On the strongest signals the response for the best adjustment of the locally generated current was approximately one and one-half times as great as that of the equal heterodyne, but on weaker signals amplification of fifty-five times was obtained.

In the third test, measurements were made for the purpose of determining the relation between the maximum signal strength obtainable with a vacuum valve and the external *heterodyne* and the signal obtainable when the same valve is coupled as a *self-heterodyne*. An average amplification of approximately fifty times was secured.

In summary, then, the *equal heterodyne*, the *optimum heterodyne* and the *self-heterodyne* gave amplifications respectively of *five, twenty, and fifty*, making a total amplification of 5,000 or possibly more.

It has been shown by Armstrong, that the true keynote to this in-

*See Proceedings of the Institute of Radio Engineers, Vol. 5, No. 2, April, 1917.

crease of amplification above the mathematically established factor of four, lies in what may be called the "*heterodyne characteristic*," i.e., the relation between the *telephone signal strength* and the ratio of the local to the *signalling current*. A number of experimental curves were published and in all cases beyond the 1 to 1 point, the increase of the local to the signalling current produced a very rapid increase in the telephone signal strength which rose to a maximum value rather rapidly and then fell off to zero.

The rapid rise of the curve as the local current is increased beyond the 1 to 1 point is due to the shape of the *rectifying or valve characteristic*; that is, the *relation between the grid voltage* (with respect to the filament) and the *grid to filament current*. The grid current is the actual conduction current flowing from grid to filament and it is upon the amplitude of this current that the value of the cumulative charge in the grid condenser depends. Two curves were published, one showing the grid-voltage, grid-current characteristic for the *equal heterodyne*, and the other for the *optimum heterodyne*. By simple analysis, it was shown that the variation of current is obviously very much greater with the optimum heterodyne.

53. **KENOTRON AND PLIOTRON VACUUM TUBES.**—Dr. Irving Langmuir and Saul Dushman, together with Mr. William C. White, have described in various publications the two-electrode and three-electrode vacuum valve tubes, which they have been instrumental in developing. These are simply extensions of Fleming's original disclosures. The two-electrode valve called the "*Kenotron*" is shown in Figure 81, and the three-electrode valve termed the "*Pliotron*" is shown in Figure 82. These tubes are exhausted to an exceedingly high vacuum by an elaborate process.* The "*Kenotron*" is employed principally as a rectifier of high voltage alternating currents, but obviously, small bulbs might be employed as oscillation detectors for the reception of wireless telegrams.

With a plate potential as low as 200 volts electron currents up to one ampere have been secured with these tubes, but, as pointed out by Langmuir, a more serviceable tube is one designed for electron currents of 250 milliamperes. If a greater current is desired, several "*Kenotrons*" may be operated in parallel.

The "*Kenotron*" tubes have been employed to rectify alternating currents up to 180,000 volts. For any purpose for which high voltage direct current is desirable, they have proven practical and serviceable.

*See Proceedings of the Institute of Radio Engineers, Vol. 3, No. 3, pp. 287-289, Sept., 1915.

The particular tube shown in Figure 81 is designed for potentials up to 50,000 volts. As a rectifier it has shown an efficiency of 97.8%.

In the three-electrode tube or "Pliotron" in Figure 82, the grid is shown at *G*, the filament at *F*—which is supported by a glass frame—

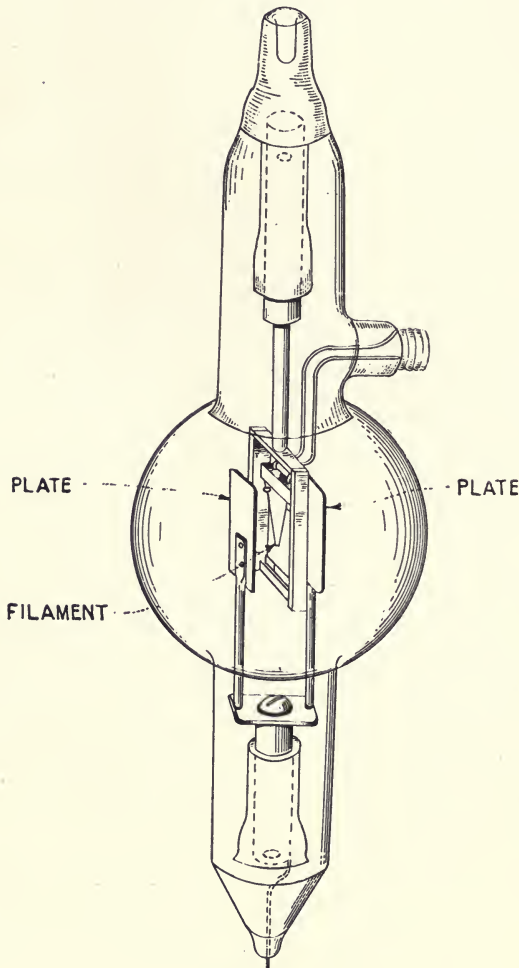

Figure 81
Showing the general construction of the Kenotron rectifier.

and the plate or anode at *A*. The *grid* consists of a number of turns of *tungsten wire* .01 millimeter in diameter, spaced to include 100 turns to the centimeter. The *filament* is mounted inside the grid. The *plates*

or *anodes* placed on either side of the filament consist of tungsten wire wound zig-zag in the manner shown.

A large "Plotron" which may be termed a "power" bulb is shown in Figure 83. A tube of these dimensions may be employed to generate several watts of radio frequency alternating current from a source of direct current. Hundreds of bulbs may be connected in parallel for the production of radio frequency currents at very large powers.

A battery of tubes may be employed to *control the output of a radio frequency alternator*, either for radio telegraphy or telephony. For example, as pointed out by Dr. Langmuir, if the plate is connected to

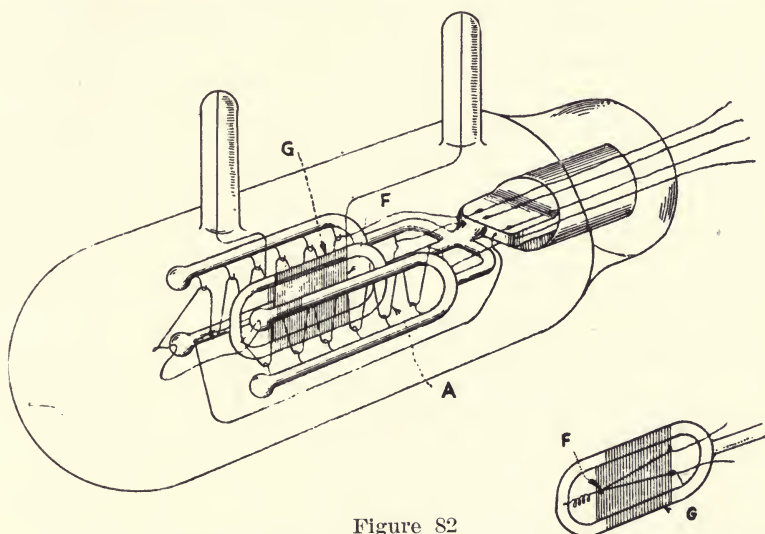

Figure 82

A small sized Plotron for use as an oscillation detector. G is a tungsten grid; F, a tungsten filament and A, the anode of tungsten wire.

a point of high potential in the antenna system (with the filament connected to earth) and the grid is held at a highly negative potential, no leakage of the antenna current takes place. But, if by an external electromotive force, the grid potential is decreased, sufficient energy may be withdrawn from the antenna circuit to damp out the oscillations. Telegraph signalling may thus be accomplished.

Radio telephony may be carried on by connecting the grid and filament to the secondary of an induction coil, the primary of which includes a microphone transmitter and a battery. Fluctuations of the primary current in the microphone circuit will impress upon the grid of the valve a *vocal current* of several hundred volts which, in turn, will vary the amplitude of the radio frequency currents flowing in the antenna circuit.

In the curves for the tube of Figure 82, published by Dr. Langumuir, approximately 26 volts negative grid potential reduces the plate current to zero. A positive potential of 10 volts affords a plate current of nearly ten milliamperes. With the grid at zero potential, plate current

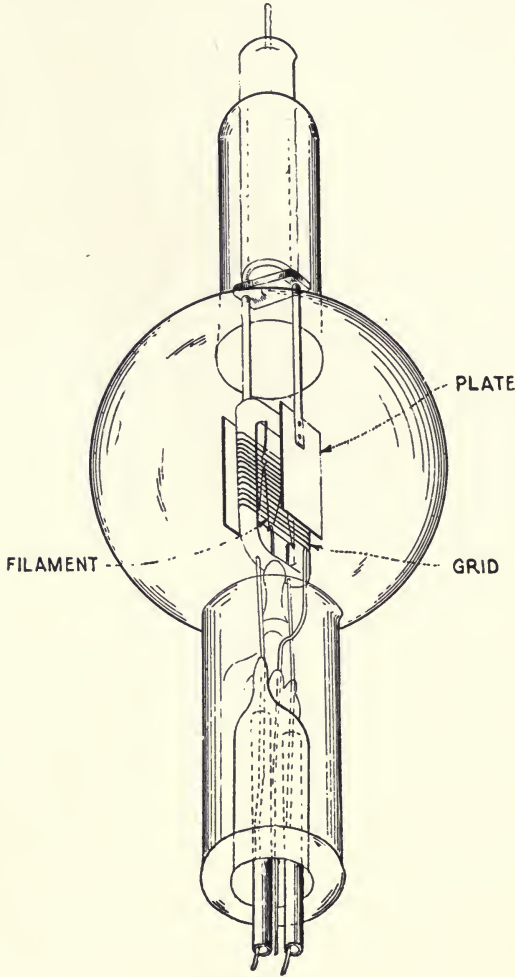

Figure 83
A "power bulb" Pliotron.

of nearly six milliamperes is secured. On the other hand, for the large "Pliotron" shown in Figure 83 with the grid potential at -375 volts, the plate current is zero and at -105 volts, the plate current is 230 milliamperes.

Mr. William C. White has disclosed two circuits for practical use

of the "Pliotron," one for the production of *high voltage radio frequencies*, and the other for the production of *low voltage radio frequencies* at large current values.

The "Pliotron" when used as an oscillator for the production of alternating current from a direct current source of energy has the characteristics of the three-electrode valve as already discussed, *i.e.*, an *amplifying relay*. That is, the wave shape of any variable electromotive force applied between the filament and the grid will be faithfully reproduced in the plate circuit. Therefore, the input of a small amount of alternating current energy will set up a relatively high amount in the plate circuit identical in frequency and wave shape.* By utilizing a small proportion of the alternating current energy thus produced to feed back to the grid circuit, this system can be made *self-exciting*. The "Pliotron" thus becomes a converter of direct currents into radio frequency alternating currents and can be used for various purposes in the technical laboratory. In connection with the circuit of Figure 84 for the production of radio frequency currents at low voltages, Mr. White points out first that in a resonance circuit, the current will rise until the losses become equal to the input energy; but the lower limit of power factor obtainable in practical circuits is about one-half of one per cent. This permits the maximum resonance current to attain a value of about two hundred times the value of the true energy current fed into the resonant circuit. In consequence, if large currents are desired from a small quantity of energy, the total volt-amperes in the circuit must be kept small. This condition requires large capacity and small inductance.

Again, if the amount of electrical energy which can be furnished by a certain source is limited by the amount of primary power available or by the losses in transmission, it is important that the resistance of the load be adjusted to the voltage so that the energy will be economically utilized. This implies in the case of the vacuum valve circuit shown in Figure 84, that the resistance of the heavy current circuit must be given the apparent value, the most suitable for insertion in the plate circuit of the "Pliotron."

(a) **The Connections of the Pliotron for the Generation of Radio Frequencies at High Current Values.** In the circuit shown in Figure 84, the "Pliotron" is employed to generate radio frequency currents of *high current value*. The output circuit *L-2, C-2*, of the "Pliotron" is coupled to the heavy current circuit, *L-3, C-3, A, A-1*, which in this particular case is used to calibrate ammeter *A* by *A-1* at radio frequencies.

*This is true of any properly constructed three-electrode bulb.

The grid circuit includes the inductance $L-1$. Condenser C provides the requisite electrostatic coupling to keep the system in oscillation.

It is important to carry out this calibration that the inductance of $L-3$, in accordance with the limitations discussed in the previous paragraph, be made with lowest possible amount. Usually, it consists of one or two turns of heavy conductor, and, therefore the capacity of $C-3$ must be of the order of 0.1 microfarad. By proper adjustment of inductances $L-1$ and $L-2$ and variable condenser C , the "Pliotron" will oscillate energetically at a radio frequency determined by the electrical

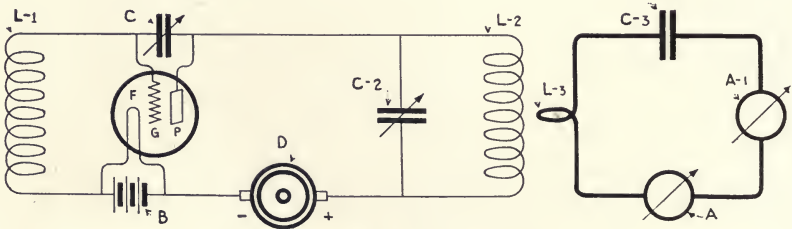

Figure 84

A Pliotron connected up for the production of continuous oscillations of high current value and high frequency.

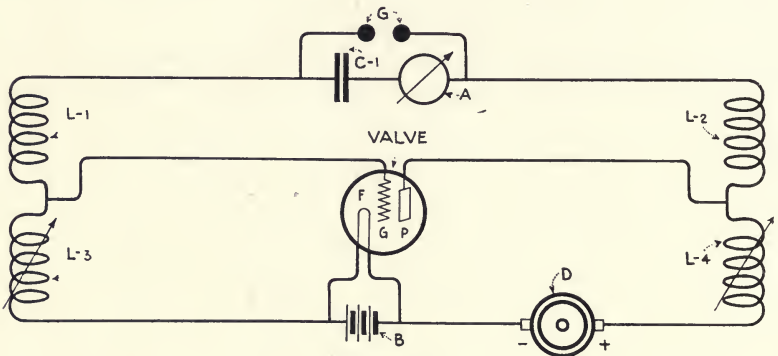

Figure 85

The circuits of the Pliotron for the production of high voltages at radio frequencies. The apparatus as connected in this diagram will produce potentials up to 12,000 volts at the spark gap G at frequencies up to 100,000 cycles per second.

dimensions of the grid and plate circuits. Because of the relative values of the inductances $L-2$ and $L-3$, the apparent resistance in the plate circuit occasioned by the coupled calibration circuit is considerably multiplied, but it is not sufficient to absorb all available energy, and to increase this apparent resistance further, a variable condenser $C-2$ is shunted about $L-2$.

The current flowing in the heavy current output circuit in Figure 84 is dependent upon the voltage of the direct current source. The most practical range has been found to be between 200 and 750 volts. Connected as shown in this drawing the "Pliotron" will generate current at frequencies from 100,000 to 1,000,000 cycles per second, and by operating several tubes in parallel much larger current outputs may be obtained.

(b) **The Pliotron as a Generator of High Voltages at Radio Frequencies.** A circuit for the production of *high-voltage radio frequency currents* is shown in Figure 85. Here the inductances $L-1$ and $L-2$ are of approximately 8 millihenries each. Inductances $L-3$ and $L-4$ are of approximately 2.5 millihenries each. The latter are preferably of the variometer type, but a simple coil fitted with plug contacts satisfies the requirements.

The plate voltage is furnished by a direct current generator, D . A high voltage condenser in series with a hot-wire ammeter A is shown

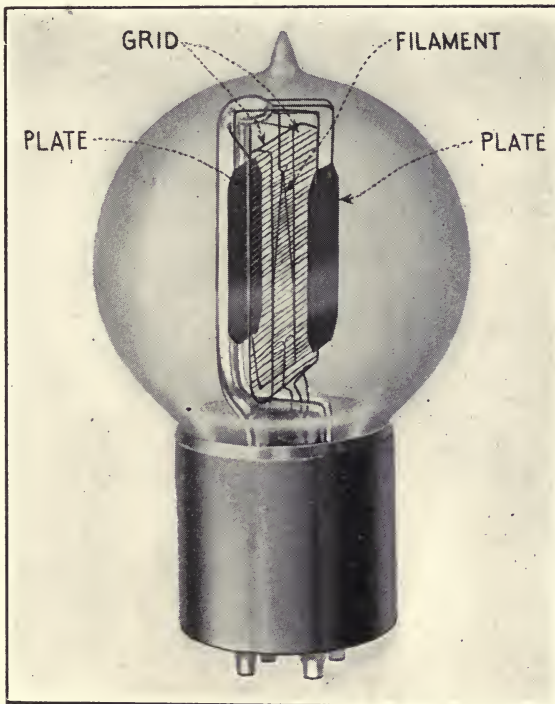

Figure 86
Showing the construction of commercial type of three-electrode vacuum valve.

at *C-1*. The capacity of *C-1* should lie between 20 and 200 micro-microfarads for a frequency of 100,000 cycles. Knowledge of the currents flow at *A* and the frequency of the circuit permits the voltage across the condenser *C-1* to be simply calculated.

If the inductances and capacities* are properly proportioned for a frequency of 100,000 cycles and the voltage of the dynamo lies between 200 and 750 volts, voltages up to 12,000 may be secured at the spark gap *G*. The object of having *L-4*, Figure 85, variable is for the purpose of applying the high frequency energy from the "Pliotron" to the resonance circuit at the correct voltage so that the energy available is used most advantageously in the resistance of this circuit.

A commonly used type of three-electrode valve as an oscillation detector is shown in Figure 86. The material of the grid, plate and filament being as follows: The filament is made of lime coated platinum and is energized by a 4 to 6 volt battery; the grid is composed of a number of turns of tungsten wire spaced equally on either side of the filament. The plates are made of sheet nickel $\frac{1}{2}$ " by 1" placed on either side of the grid. The voltage of the plate circuit varies from 90 to 150 volts or more.

*Mr. White mentions that two metal plates 10" by 10" placed approximately $\frac{1}{2}$ " apart will afford a condenser having capacity of approximately 40 micro-microfarads.

PART VII

WIRELESS TELEPHONY

54. **In General.**—The art of wireless telephony has been so aptly and completely covered in Dr. Goldsmith's "Radio Telephony" that the subject will be touched upon lightly here. The vacuum tube, however, occupies such an important place in wireless telephone systems, that this volume could not be considered complete without some mention of certain circuits which have been disclosed by various investigators.

In general, wireless telephone conversations are transmitted by radio frequency wave motion termed the *carrier wave*. This carrier wave is modulated at an audio frequency by a microphone transmitter such as employed in land line telephony. Thus, any undamped wave transmitter and any type of oscillation detector giving a quantitative response may be employed provided a magnetic telephone is the current translator.

Consider, for example, a wireless transmitter which generates a steady wave stream of continuous amplitude. If a wireless receiving set containing a simple rectifier and a telephone is tuned to this transmitter, pulses of direct current in rapid succession traverse the telephone windings but produce no sound. But if the amplitude of the radiated energy is modulated at an audio or vocal frequency through a microphone, the amplitude of the rectified telephone current will be varied, at a vocal frequency in accordance. Hence, the diaphragm of the telephone will vibrate at the same rate as the diaphragm at the transmitter.

The audio frequency variations occasioned by the microphone generally occur at rates from 100 to 2,000 per second, the mean average being approximately 1,000 per second. This average value has been termed the "*mean speech*" frequency.

The great problem heretofore in radio telephony has been the diffi-

culty of modulating the large powers employed at the transmitter by the usual telephone microphone which at its best can handle approximately from one-half to one ampere of current. Owing to the inherent imperfections of the microphone and its limited current carrying capacity, a continuously operative high power radio telephone system was not produced until the advent of the vacuum tube.

In the earliest radiophone systems, a number of microphones were connected in parallel, and then in series with some part of the antenna system or in special circuits associated inductively or conductively with the antenna system; but owing to the "packing"* of the microphone and the difficulty of over-heating, only very small powers could be employed.

Various types of high power microphones have been constructed, but they cannot be said to have satisfied the demands of modern engineering, *i.e.*, they were not continuously operative.

Experiments have been made wherein the microphone was connected in the field circuit of a D. C. generator supplying current to an *arc generator*, or in a similar way to alter the field excitation of a *radio frequency alternator*; but such systems were only partially successful, because of the small current carrying capacity of the microphone and the consequent limited degree of modulation of the antenna current.

In general, we may state that the systems of radio telephony so far proposed contemplate the generation of a *carrier wave* above the limits of audibility, and the modulation of either the amplitude or the wave length of the wave at speech frequency. In some systems, one or the other function is performed individually, but in others both occur to a limited degree simultaneously.

The vacuum tubes seem to offer a practical solution of this problem, for, as already explained, they can be employed to generate radio frequency alternating currents of any desired frequency. The grid potential-plate current characteristic of a properly constructed valve indicates also that a very slight change in the grid potential will cause a relatively large variation of the plate current. Hence, if a vacuum valve be connected up for the production of continuous oscillations and a microphone and battery be connected inductively or conductively to the grid circuit, the grid potential will rise and fall in accordance with the sound modulations of the human voice and the amplitude of the radio frequency carrier wave will be modulated at vocal frequencies.

(a) **Fundamental Circuits of the Three-Electrode Tube as a Radiophone Transmitter.** A diagram typifying this system of connec-

*Coherence of the carbon granules.

tions is shown in Figure 87. The grid and plate circuits of the vacuum tube are magnetically coupled at $L-1$ and $L-2$, both circuits being tuned to a given frequency of oscillation by condensers $C-1$ and $C-2$ and the inductances $L-1$ and $L-2$. A similar circuit has been shown in Figure 60. The antenna circuit A, L , may be coupled to either the plate coil $L-2$ or the grid coil $L-1$. If tuned to resonance, considerable amounts

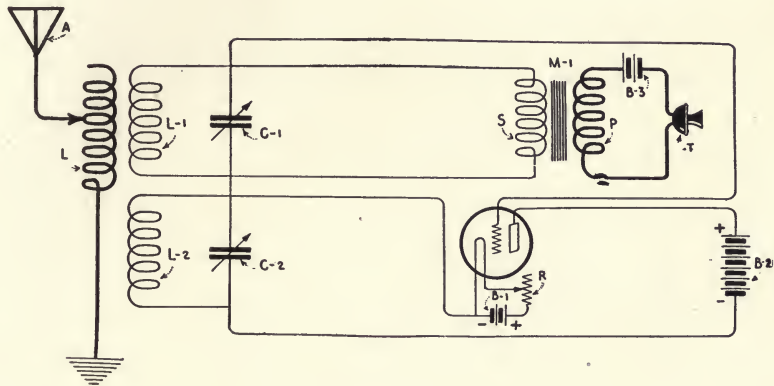

Figure 87

Vacuum valve connected up for the production of continuous oscillations for radio telephony.

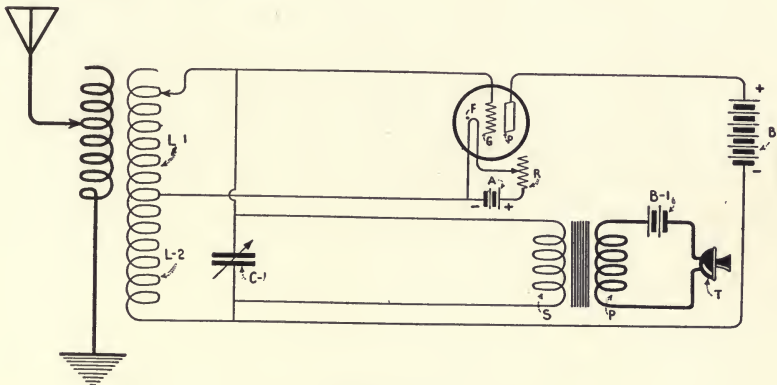

Figure 87a

Modified connection of the microphone to the valve generator for radio telephony.

of energy will be withdrawn from the valve circuits into the antenna system from which part of the energy is radiated in the form of electromagnetic waves.

An induction coil $M-1$ with the primary and secondary windings P

and S respectively may be connected to the condenser $C-1$, the primary circuit of the coil including the microphone T and the battery $B-3$. By proper design of the induction coil, two or three hundred volts may be impressed upon the grid and a very great modulation of the antenna current thus secured. Valves employed for the generation of radio frequencies at high powers have grid potentials of 150 volts negative, and the plate potentials may attain 2,000 volts or more. It should be understood that Figure 87 is simply a suggestive circuit. It may be re-drawn as in Figure 87a, coils $L-1$ and $L-2$ being considered as one long coil tapped at the center to the filament. A single condenser $C-1$ can be

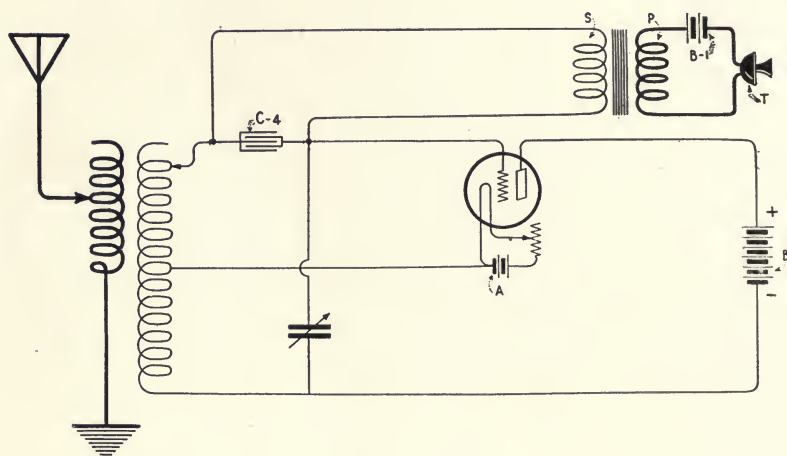

Figure 87b

Another method of connecting the microphone to the valve generator.

used to tune the plate and grid circuits simultaneously. The microphone and its induction coil may be connected as in Figure 87a, or in another way as in Figure 87b, where a large condenser $C-4$ is connected across the secondary terminals of the induction coil and in series with the inductance of the grid circuit.

There are many combination circuits for wireless telephony in which the three-electrode vacuum tube may be employed in one way or the other. For example:

- (1) A number of bulbs connected in parallel may generate the requisite radio frequency current and one or more additional bulbs including a microphone transmitter may be used to vary the output of the "power bulbs" by variation of their grid potential.
- (2) The radio frequency current for the carrier wave may be generated by a radio frequency alternator and modulated by connecting a three-electrode valve at some effective point in the antenna system.

- (3) A battery of "power" vacuum tube bulbs may be employed to amplify the output of a small radio frequency alternator and the grid potential varied at mean speech frequency by additional bulbs including in their grid circuit an induction coil and a microphone.
- (4) A battery of tubes controlled by a microphone may vary the field excitation of a radio frequency alternator.

(b) **Rounds' Wireless Telephone System.** A few examples of proposed systems will be described. The first system to employ the vacuum valve as a source of oscillations for wireless telephony was that developed by H. J. Rounds of Marconi's Wireless Telegraph Company, Ltd., which is shown in Figure 88. It will be noted in this diagram that the grid and plate circuits of a vacuum tube are coupled at *L-3* and *L-4*, the antenna being coupled to the grid circuit at *L-1*. The plate battery *B-2* varying

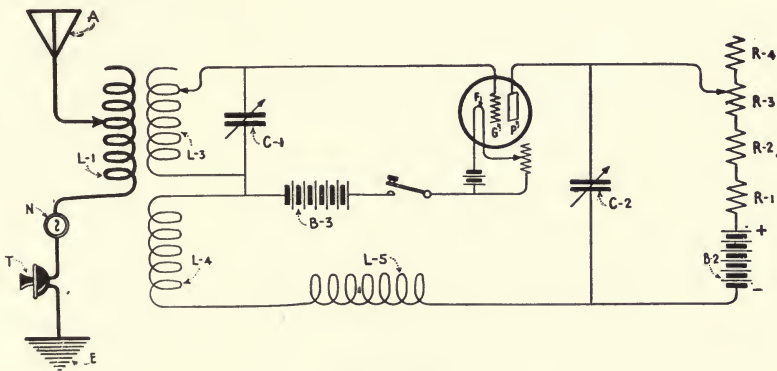

Figure 88

Rounds' system of wireless telephony. Continuous oscillations are generated in the circuits of the tube *F*, *G*, *P*, transferred to the antenna through the coupling *L-1*, *L-3*, and modulated by the microphone *T*.

from 500 to 2,000 volts is shunted by the condenser *C-2*. Four resistances, *R-1*, *R-2*, *R-3*—of 500 ohms—and *R-4* of 10,000 ohms, are connected in series with the plate battery.

The filament battery is an 80 ampere hour 6 volt cell, and the grid battery *B-3* has a voltage of approximately 500 volts. A microphone *T*, is connected in series with the antenna circuit as well as a small glow lamp *N*, which is employed to indicate conditions of resonance between the generating circuit and the antenna circuit.

The entire system is set into oscillation by opening and closing the key connected in the grid circuit. Resonance is established by careful adjustment of condensers *C-1* and *C-2*. By further adjustment of the reaction coupling and by tuning the antenna circuit, the small glow lamp *N*, will light to full brilliancy. This indicates that the antenna

circuit is in a state of oscillation, that is, N takes the place of the antenna ammeter. When the transmitter T is spoken into, the radio frequency wave is modulated at speech frequency and response will then be secured at the receiving station. Note should be made of the fact that the microphone as here connected in the circuit is not in the most effective position, but later circuits developed by Rounds show the microphone connected in some part of the grid circuit. With the connections of Figure 88, radio telephony was accomplished over distances up to 50 miles.

55. HUND'S METHOD OF RADIO FREQUENCY MODULATION.—A method for controlling the *carrier wave* at an *audio* or *vocal* frequency suggested by August Hund, is disclosed in Figure 89. In this system, the antenna oscillations are modulated at vocal frequency by a three-electrode vacuum tube. The radio frequency currents for the carrier wave are generated by the vacuum tube V , the grid and plate circuits being coupled together as usual for the generation of radio frequency currents. By coupling $L-2$ to $L-1$, currents of similar frequency are induced in the antenna circuit.

The antenna system further includes the coil $L-3$ which may have from 6 to 15 microhenries inductance. The terminals of $L-3$ are connected to the plates $P-1$ and $P-2$ of the three-electrode bulb $V-1$.

The filament $F-1$ is rendered incandescent by the battery $B-1$ and the potential of the grid to filament varied at speech frequency by the microphone T through the iron-core induction coil $P-1$, $S-1$. The potential of the grid in respect to the filament can be maintained at the most satisfactory value by battery $B-3$ and potentiometer P . The grid normally is held at a fairly high negative potential so that no currents leak around $L-3$ through the valve $V-1$; but when the microphone T is spoken into, the valve becomes conductive at vocal frequencies; one-half cycle of the carrier wave leaks through the conduction path from $P-1$ to $F-1$, and similarly the other half cycle through the conduction path from $P-2$ to F . Energy is thus withdrawn from successive cycles of the carrier wave in accordance with the vocal wave impressed upon the grid by the microphone T and the transformer $P-1$, $S-1$. In summary, the grid potential is modulated by the microphone, and the antenna current leaks from plates $P-1$ and $P-2$ to filament $F-1$. The antenna oscillations are damped out at speech frequency.

Obviously, two valves might be employed to secure this leakage.

56. ENGLUND'S WIRELESS TELEPHONE SYSTEM.—It has been established that if the frequency of the carrier wave in wireless telephony is of constant amplitude and F cycles per second, and it

is modulated at a vocal frequency f such as generated by a microphone, there will be radiated into the ether a complex wave which is made up of three component frequencies f , $F' - f$, and $F' + f$. It is evident that the unmodulated component of the antenna current F' since it does not contain the signal frequency f , need not be present in the antenna, but it may be supplied by an auxiliary source at the receiving station. Hence, if by any means the carrier frequency F' can be eliminated, except as at such

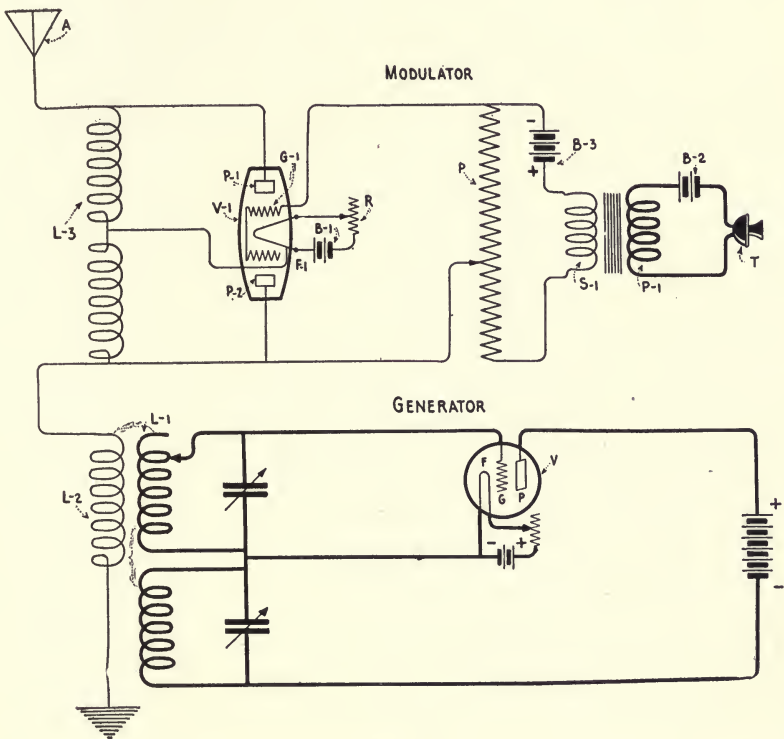

Figure 89

Hund's proposed method for modulating radio frequency currents by a microphone.

times that the wireless telephone transmitter is spoken into, a considerable wastage of energy is prevented, and, furthermore, the carrier frequency F' will not interfere with the operation of other stations in proximity.

In Englund's proposed system, shown in Figures 90* and 91*, this phenomenon is taken into consideration and means have been devised

*It cannot be said that systems outlined in these diagrams have attained the stage of practical commercial application. They are merely published to indicate the general trend of experimentation.

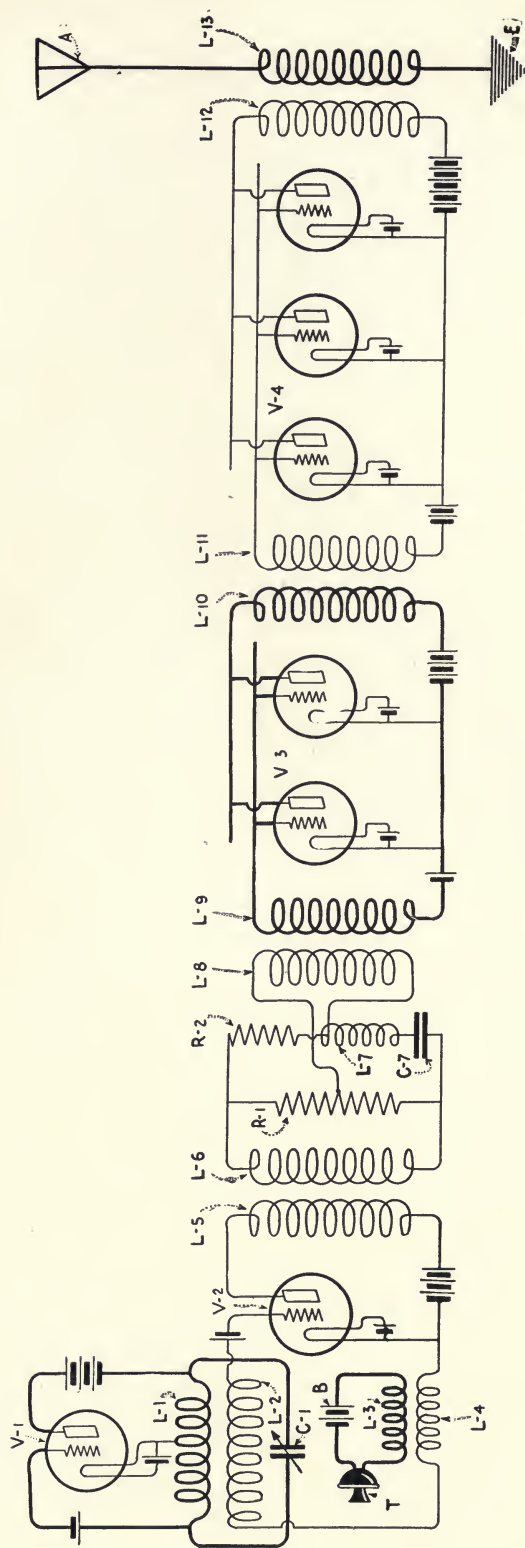

Figure 90

England's vacuum tube system for wireless telephony. In this system the radio frequency currents generated by a small three-electrode tube V-1 are amplified and modulated by a microphone coupled to the input circuit of a tube V-2, the resulting currents of vocal frequency being further strengthened by the amplifiers V-3. The output circuits of V-3 are in turn coupled to a battery of power bulbs V-4 whose output circuit is coupled to the antenna circuit A, L-13, E. In a circuit of this kind an initial radio frequency current of a few watts may set up current of similar form of many kilowatts in the antenna circuit. A feature of this system is the elimination of the carrier frequency. The antenna does not radiate except when the microphone transmitter is actuated.

whereby the antenna circuit, Figure 90, *A*, *L-13*, *E*, is traversed by modulated currents only when the transmitter "T" is spoken into. From this diagram, the student receives some hint of the fundamental circuits of a long distance wireless telephone system in which vacuum valves are employed not only to generate the radio frequency current but to modulate it at speech frequency as well.

It is to be noted first, that the plate and grid circuits of the vacuum tube *V-1* called the *master oscillator*, are coupled through the coil *L-1* and condenser *C-1* for the production of radio frequency currents, that is, the grid and plate circuits are coupled in such a way as to

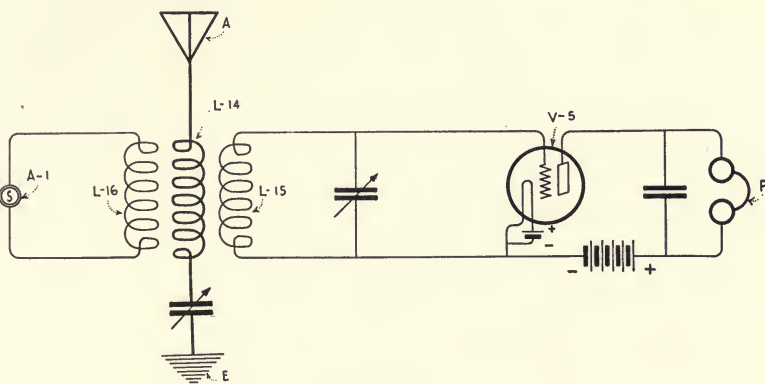

Figure 91

Receiving apparatus of England's system. The carrier frequency is supplied by a local generator *A-1*.

set the circuits of *V-1* into oscillation. Coupled to *L-1* is the secondary coil *L-2* which in turn is connected to the grid and filament of another vacuum tube *V-2* termed the "modulator."

The output circuit of the "modulator" bulb is coupled to *L-6* through *L-5*. The circuit of *L-6* in turn contains a bridge consisting of resistances *R-1*, *R-2*, inductance *L-7*, and condenser *C-7*. Tapped across this bridge is the inductance *L-8* coupled to *L-9*, the terminals of which in turn are attached to the grid and filament (the input circuit) of a battery of tubes *V-3*.

By properly balancing the bridge, no current flows through *L-8* at the carrier frequency *F*, but currents of a frequency differing from that of the carrier frequency destroy the balance according to the frequencies of the vocal currents generated by the human voice. The modulated currents are then amplified by the vacuum tubes *V-3* connected in parallel.

The output circuits of these bulbs are in turn coupled to the grids and filaments of the battery of power bulbs *V-4* of which there may be

any number connected in parallel. The plate circuits of $V-4$ may be fed by a direct current dynamo or a large storage battery. Their output circuits are in turn connected to the antenna system at $L-12$ and $L-13$.

Beginning at the extreme left-hand part of the drawing, Figure 90, a circuit will be seen containing the microphone " T ," a battery B , and an induction coil $L-3$, $L-4$, which is coupled to the input circuit of the *modulator bulb* $V-2$. The radio frequency current modulated by the microphone unbalances the bridge network above mentioned and the resulting currents are amplified through the batteries of bulbs $V-3$ and $V-4$. The oscillator $V-1$, of course, can be replaced by a small radio frequency alternator.

Very feeble currents flowing through microphone T can control antenna current of many kilowatts, thus greatly increasing the distances over which wireless telephony can be carried on.

Since the carrier wave of frequency F has been eliminated by this process, it must be supplied at the receiving station. The diagram, Figure 91, shows a radio frequency alternator $A-1$ (for which may be substituted a vacuum valve connected up for the production of radio frequency oscillations) coupled inductively to the antenna system at $L-16$ and $L-14$. A vacuum valve $V-5$ is employed for purposes of detection. It is inductively coupled to the antenna circuit through coil $L-15$.

The inventor claims that in addition to the elimination of the waste of energy by this system there is a slight improvement in the quality of received signals due to the elimination of the frequency F .

57. CARSON'S PROPOSED WIRELESS TELEPHONE SYSTEM.— Another system has been disclosed by John Carson in Figure 92, in which the antenna does not radiate except when the microphone is spoken into. It is to be noted in this diagram that the field current of a radio frequency alternator A is modulated at vocal frequencies by a microphone T , the currents of which are amplified by a vacuum tube V . The field windings F of the alternator are thus excited at speech frequency and the amplitude of the radio frequency current generated by A varied accordingly.

The complete microphone circuit includes the *transmitter* T , the *battery* B , and the *induction coil* P , S . Winding S is connected to the *grid* or *input* circuit of a three-electrode valve V , the *plate* or *output* circuit of which includes the primary winding of an induction coil $P-1$ coupled to the secondary winding $S-1$. The secondary circuit includes the condenser C and the field winding of the alternator F . The armature of the alternator A is connected to the grid or input circuit of the tube $V-1$ whose plate circuit $C-1$, $L-1$, may be fed with direct current from battery

or direct current dynamo. This tube repeats and amplifies the radio frequency currents impressed upon its input circuit and the oscillations in the output circuit are transferred to the antenna through the coupling $L-1$ and $L-2$. The impedance of the circuit $S-1$, C , F' to the vocal currents is reduced by condenser C .

In summary, the modulated currents of the microphone circuit T , P , B , are amplified by bulb V , and a fluctuating current circulates through field winding F' which varies the output of the radio frequency alternator A at a vocal frequency. A current, the reproduction of the signalling current, therefore flows in the antenna which radiates only

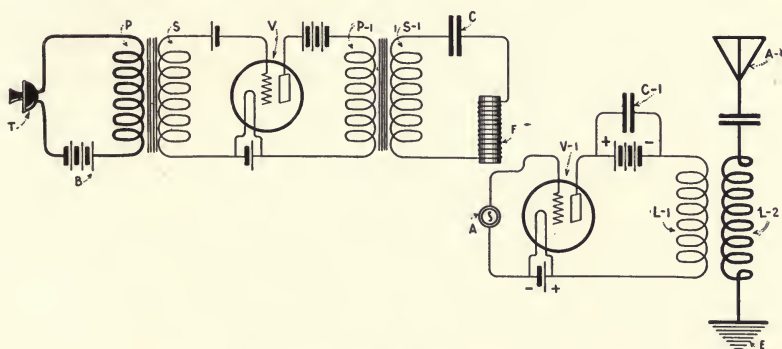

Figure 92

Carson's system for wireless telephony. The output of a radio frequency alternator A is varied at vocal frequency through a microphone T and an amplifier bulb V . This in turn varies the current input in the field windings F of the alternator.

when the microphone is in operation. The amplitude of the high frequency wave radiated from the antenna is directly proportional to the low frequency signalling wave, hence the telephone diaphragm at the receiving station is deflected at vocal frequencies.

In ordinary systems, as we have already mentioned, there is a continuous radiation in the form of an unmodulated carrier wave even when the transmitter is not spoken into. The transmission of this wave, besides involving a waste of energy, constitutes a serious bar against the operation of duplex systems.

58. ESPENSCHIED'S DUPLEX WIRELESS TELEPHONE SYSTEM.— Among the attempts that have been made to secure simultaneous transmission and reception in wireless telephony, the system evolved by Lloyd Espenschied is of interest. A problem of considerable magnitude is encountered in duplex transmitting and receiving systems

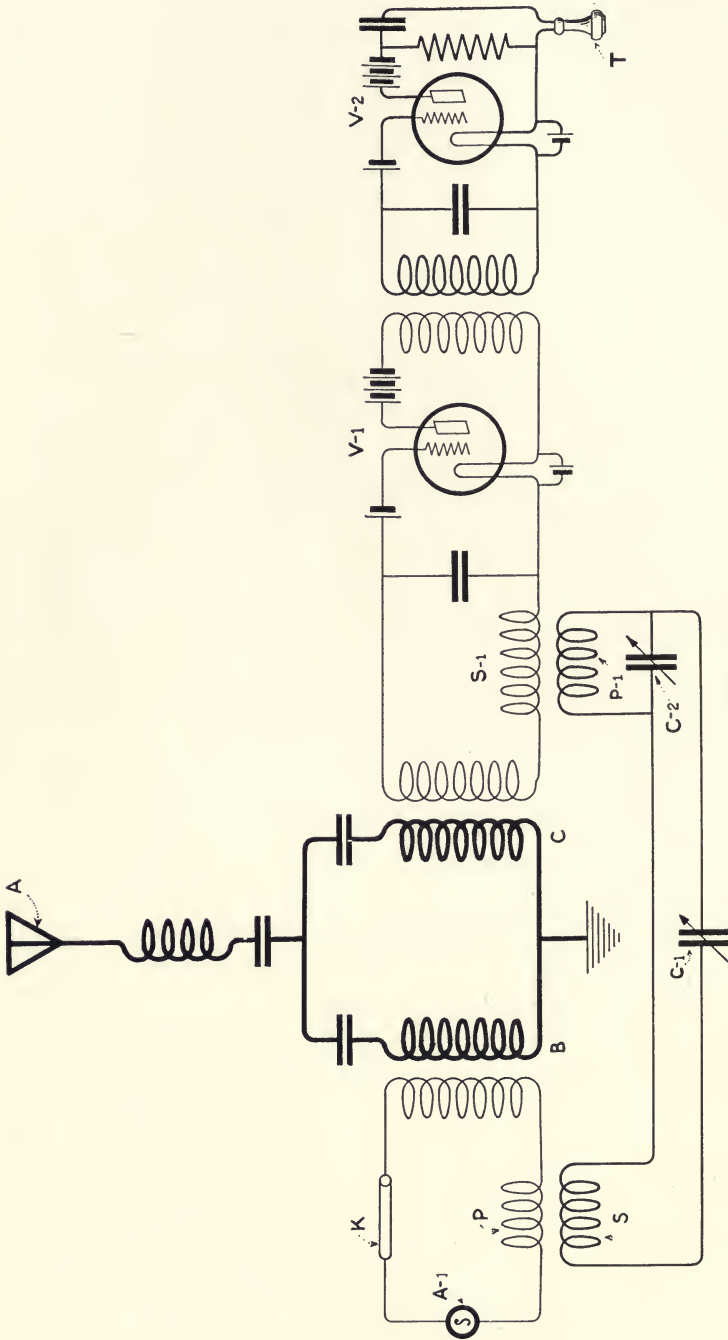

Figure 98

Espenschied's system for simultaneous transmission and reception in wireless telephony.

because of the large amounts of power used for transmitting compared to that flowing in the receiving systems, the ratio being approximately one million to one. This inventor believes he has solved the problem through the use of specially devised balancing out circuits.

The embodiments of Espenschied's system are shown in the diagram of Figure 93, additional circuits being shown in Figures, 94 95 and 96. In the systems shown in these diagrams the inventor secures duplex operation by employing different carrier frequencies for transmission and reception. Through the selectivity thus afforded and by the aid of additional balancing out circuits, either the same aerial or two different aeriels may be employed for simultaneous transmission and reception.

In brief, the antenna system shown in Figure 93, comprises two parallel branches *B* and *C* which gives the complete system two natural frequencies of oscillation. Branch *B* is coupled to a continuous wave generator *A-1*, and branch *C* is coupled to a valve amplifying system including the tubes *V-1* and *V-2*. The speech signals are translated through the medium of the telephone *T* connected in the output circuit of the tube *V-2*.

Keeping in mind the enormous volume of energy flowing in the transmitting branch compared to that in the receiving branch, it is clear that some means of balancing out the effect of branch *B* upon the branch *C* must be employed. This is accomplished by the balancing out circuit *S*, *C-1*, *C-2*, *P-1*. *S* is coupled to the radio frequency generator *A-1* and to the input side of the three-electrode valve at *P-1*, *S-1*. By proper adjustment of the phase relation of the balancing out current and the current of similar frequency induced in the receiving system, complete annulment is secured in the branch *C*. It must be remembered that the frequency of the balancing out circuit is that of the transmitter. Hence, only currents of this frequency are suppressed in the receiving system, leaving it free to receive waves at a frequency differing from that of the radio frequency alternator *A-1*. Careful adjustments of the couplings *P*, *S*, and *P-1*, *S-1*, are essential for successful operation.

The correct phase relation between the balancing currents is obtained by proper adjustment of capacity of the condensers *C-1* and *C-2*.

The circuit shown in Figure 94 is in all respects similar to Figure 93 with the exception that the balancing out circuit includes a vacuum tube *V-3* which amplifies the effect of generator *A-1*. Better balance of the opposing E.M.F.'s is thus secured.

It is thus seen that in a general way the circuits of Figures 93 and 94 simulate the circuits of wire telephony, the apparatus always being in a position to transmit and receive.

A system involving the use of separate aeriels for transmission and

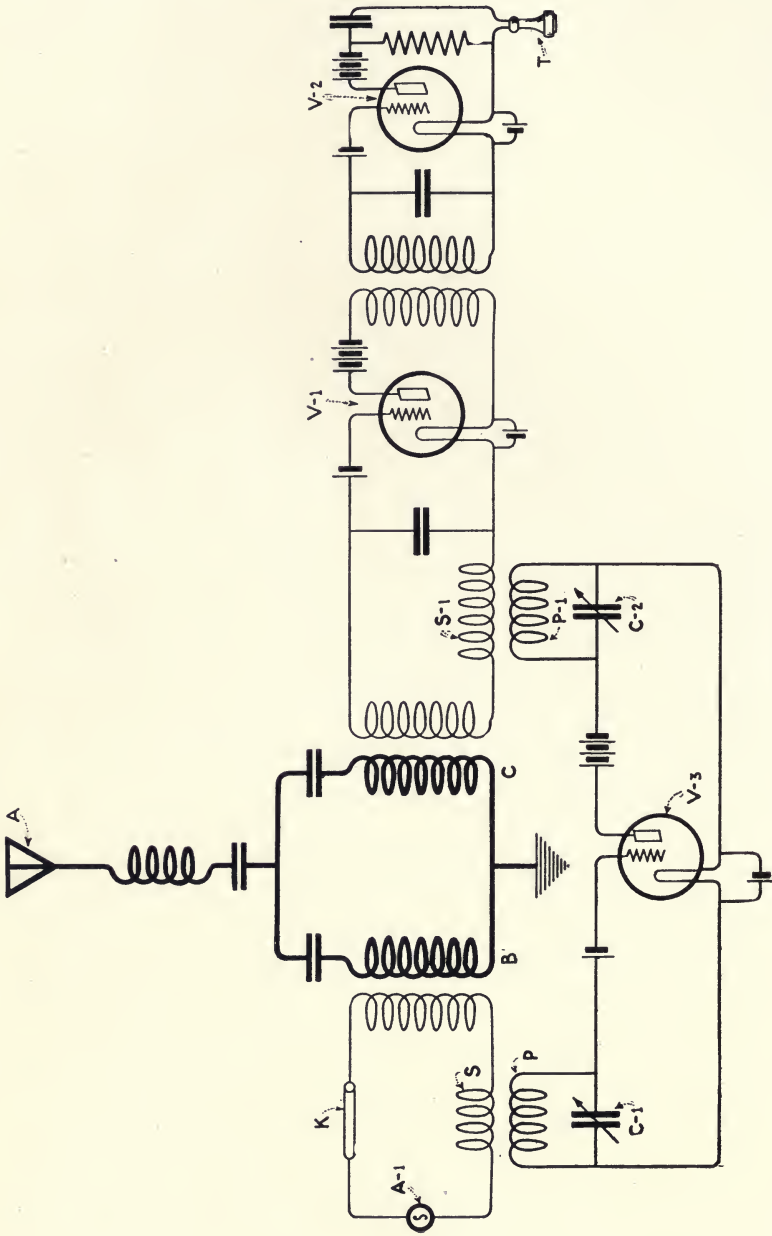

Figure 94

Modified system evolved by Espenschied for simultaneous transmission and reception of wireless telephonic signals. The interfering currents in the receiving system are balanced out by a special circuit P, C-1, P-1, C-2.

reception of speech signals disclosed by Espenschied is shown in Figure 95. The aerial of the transmitter is indicated at *W*, and of the receiving station at *W-1*. The source of radio frequency current for the carrier wave is shown at *A-1*, the output of which is amplified by means of the three-electrode vacuum tubes *V-1* and *V-2*, the output currents of the latter tube being fed to the aerial *W* at the coupling *P, S*.

The receiving system embraces the coupling transformer *P-1, S-1*, the incoming signal being amplified by the three-electrode tube *V-3* and detected by the tube *V-4*. The output circuit of *V-4* includes the receiving telephone *T*.

Through the transformer *M* and the microphone *T-1*, currents of vocal frequency are impressed upon the circuit *X* which also is inductively coupled at *M-1* to the alternator *A-1*. The output of the alternator is modulated at vocal frequency by *T-1*. The circuit *X* is coupled to antenna *W* at *M-3*. Radio frequency current is thus withdrawn from the antenna circuit through the circuit *X* coupled to *V-3* at *M-2*, to balance out currents of similar frequency in the receiving system. This circuit thus serves to impress currents of speech frequency upon the alternator *A-1* and to deliver radio frequency currents to the input circuit of the tube *V-3* to balance out such currents as may be induced in the aerial *W-1* by *W*. The correct phase relation of the opposing radio frequency currents is obtained by careful adjustment of condensers *C-1* and *C-2*.

In respect to the reception of signals, it is seen that antenna *W-1* is strongly responsive while antenna *W* is weakly responsive to the distant transmitter owing to the difference of frequency.

Summarizing the actions of the apparatus disclosed in Figure 95, currents of radio frequency generated by the radio frequency alternator *A-1* are amplified by a battery of vacuum valve tubes the output circuits of which are inductively coupled to the antenna. Circuit *X* serves to conduct radio frequency current from the transmitter for balancing out the effects of the transmitter upon the receiving system. It acts also as a carrier of the vocal currents generated by the microphone *T-1*.

The system shown in Figure 96 fundamentally is similar to that of Figure 95. The output of the radio frequency alternator *A-1* is amplified by the bulb *V-1*, the carrier wave being modulated at a radio frequency by the microphone *T-1* through the coupling *M*. The output circuit of *V-1* is coupled to the input circuit of the valve *V-2*, the output circuit of which is inductively coupled to the antenna through the transformer *P, S*. A balancing-out circuit shunted across circuit *X* including the condenser *C-1* and the coupling *M-2* serves to impress a modu-

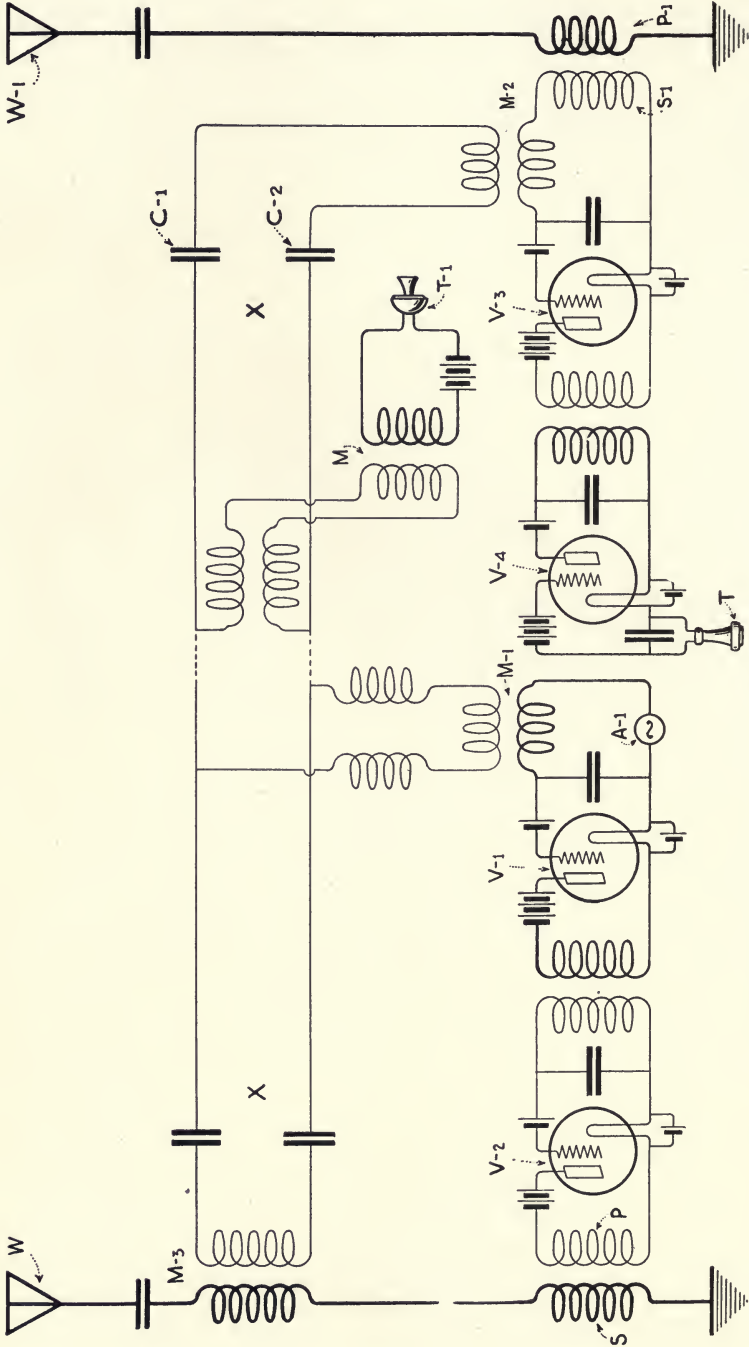

Figure 95
Espenchied's system for simultaneous transmission and reception in wireless telephony from two aerials.

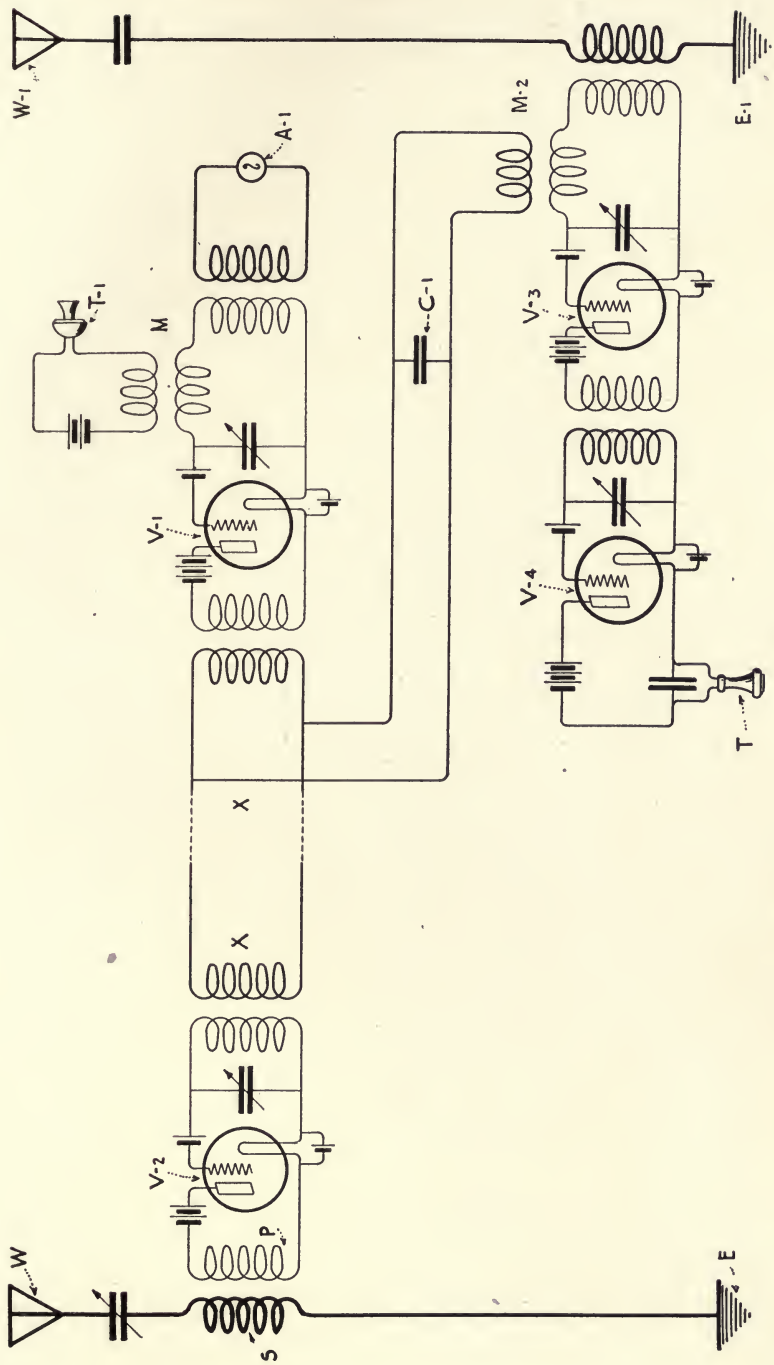

Figure 96

Espenschied's modified system for simultaneous telephonic transmission and reception from two wireless telegraph aerials.

lated radio frequency current on the input circuit of the detection tubes *V-3*, *V-4*. Thus currents of the transmitter frequency which may be induced in the antenna *W-1* are balanced out leaving the receiving system free to respond to waves of a frequency differing from that employed in the antenna system *W*. Correct phase relation of the opposing currents is obtained by means of the condenser *C-1*.

59. ENGLUND'S DUPLEX RADIO TELEPHONE AND RADIO TELEGRAPH SYSTEM.—We have remarked in paragraph 56 how a vocal wave or current of speech frequency impressed upon a radio frequency or carrier wave sets up three complex waves of frequencies $F + f$, F , and $F - f$, in which F is the frequency of the carrier wave and f the vocal wave impressed upon the carrier wave by the human voice through a microphone. Because the wave of frequency F does not contain the signal frequency, f , it represents a waste of power in the antenna system. Means were shown (in paragraph 56) whereby the current of frequency F could be practically eliminated at the transmitter but be supplied at the receiver by a local generator.

Englund has recently disclosed a novel system which not only embodies the foregoing principle, but in which the frequency F is employed for telegraphic signalling. That is, the antenna is used for simultaneous radiation of telephonic and telegraphic messages.

An important feature of the system is the fact that telegraphic and telephonic signals may be dispatched simultaneously at the same wave length from one aerial and may be received upon one aerial at the receiving station. The transmitting circuits of this system are shown in Figure 97 and the receiving circuits in Figure 98. Beginning at the left-hand side of the drawing of Figure 97, a radio frequency alternator *A* is coupled to the input circuit *B* of a modulator bulb. Coupled to the same input circuit is a microphone circuit *C* including the microphone *T*, the battery *B-3*, and the transformer *M-2*.

The output circuit of the modulator bulb contains two branch circuits *B-1* and *B-2*. The branch *B-1* comprising the inductance and the condenser serves as a short circuit to current of the frequency of the generator *A*. The parallel circuits of branch *B-2* are tuned to offer a practically infinite impedance to currents of the generator frequency and a low impedance to currents whose frequencies differ therefrom by a vocal frequency.

Through the transformer *M*, currents of vocal frequency are impressed upon the input circuit F' of the amplifying bulbs *V-1*, the output circuit *G* being coupled to a battery of power bulbs *V-2* at *M-3*. The output circuits of the latter are inductively coupled to the antenna at *M-1*. So far the circuit does not differ materially from that described in

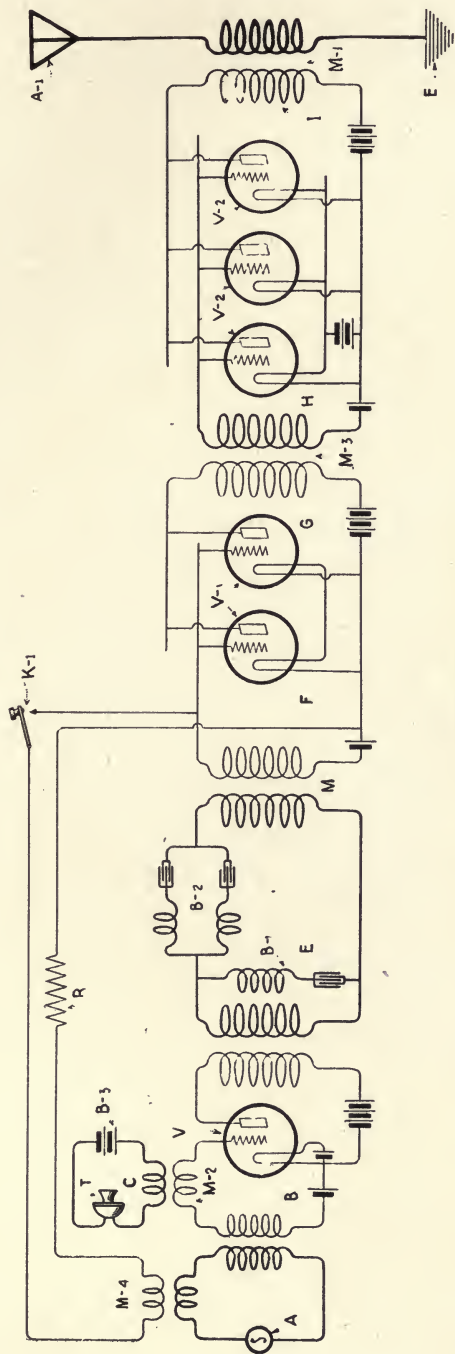

Figure 97
 Englund's system for simultaneous transmission of radiotelegraphic and radiotelephonic signals.

paragraph 56, and as already explained, the antenna only radiates when the transmitter T is actuated.

It is to be noted, however, that through the transformer $M-4$, and the telegraph key $K-1$, currents of the frequency of the generator can be impressed upon the input circuit F of the amplifying bulbs $V-1$. Therefore, during the moment that the key $K-1$ is closed, the antenna will radiate at the frequency of the alternator F . This wave motion can be detected at the receiving station by a receiver tuned to that frequency. Thus, the current of the carrier wave is superposed upon the modulated current induced in the antenna circuit by the microphone. Telegraphic and telephonic signalling may then be carried on simultaneously. During the time that the key $K-1$ is closed, the speech distortion ordinarily caused by the presence of the frequency F in the

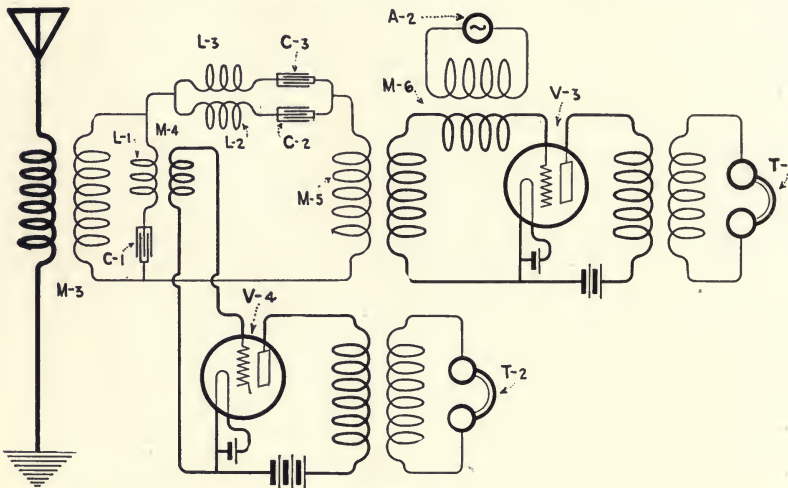

Figure 98

Receiving apparatus in England's duplex system. This system will receive telegraphic and telephonic signals simultaneously.

antenna circuit in wireless telephony, is experienced, but at all other times the frequency of the carrier wave F is eliminated. However, it does not interfere seriously with the signals of speech or vocal frequency.

To avoid short-circuiting the amplifiers $V-1$, a resistance R is placed in series with the key circuit.

The circuits of the receiving system whereby telegraphic and telephonic signals may be recorded at the wave length simultaneously is shown in Figure 98.

The carrier frequency F which has been eliminated at the transmitting station for wireless telephony, is supplied by a local generator $A-2$ which is coupled to the input side of a three-electrode valve $V-3$, the output circuit of which is connected to a telephone receiver $T-1$.

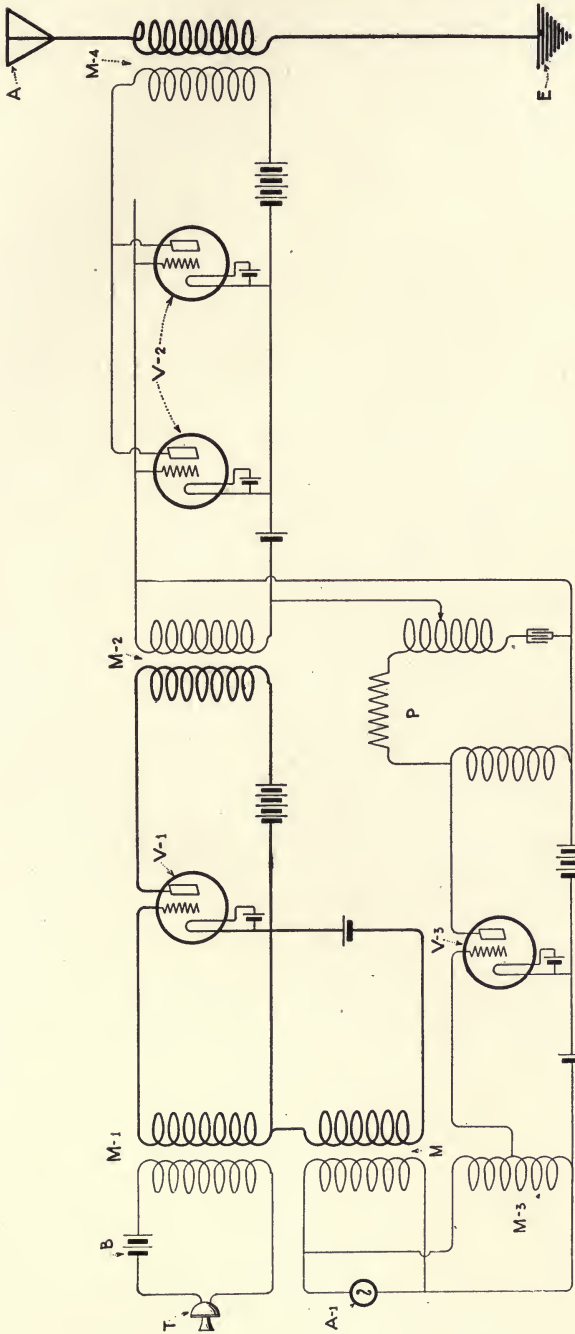

Figure 99

System proposed by England for the elimination of the carrier frequency; with the apparatus connected in this way the antenna radiates only when modulated currents of vocal frequency are generated.

The secondary of the receiving transformer $M-3$ is shunted by an inductance $L-1$ and a condenser $C-1$, the circuit further containing the inductances $L-2$, $L-3$ and the condensers $C-2$ and $C-3$. This circuit will be found similar to $B-1$, $B-2$ of Figure 97, performing similar functions. It is also to be noted that the input side of a vacuum tube $V-4$ is inductively coupled to $L-1$ by transformer $M-4$. It is in this circuit that the telegraphic signals are detected.

Keeping in mind the functions of the branch circuits $B-1$ and $B-2$, in the transmitter, the function of those of the receiver will be readily understood. Thus, oscillations of the carrier frequency will be shunted through $L-1$, $C-1$. Through the coupling $M-4$ they are impressed upon the input circuit of the tube $V-4$ and detected in the telephone $T-2$. Currents of the carrier frequency cannot appear in the transformer $M-5$ which serves to couple the antenna system to the input circuit of the valve $V-3$, but currents of modulated frequency are readily transformed through $M-5$ because of its tuning and thus are detected in the telephone $T-1$.

In summary, the telegraphic signals are detected in telephone $T-2$ and telephonic signals in $T-1$. The alternator $A-2$ supplies the carrier frequency F which has been eliminated in the telephone transmitter circuits.

Englund has disclosed another system for elimination of the carrier frequency at the transmitting station in wireless telephony, it being a modification of the circuits disclosed in paragraph 56. The complete circuits are shown in Figure 99. As usual, the radio frequency carrier wave is generated by the source $A-1$ which is inductively coupled to the input side of the three-electrode tube $V-1$ at the coupling M , the same circuit being coupled at $M-1$ to the transmitter circuit including the microphone T , and the battery B . The output circuit of $V-1$ is inductively coupled through $M-2$ to the input circuit of the power bulbs $V-2$. The output circuit of the latter is, in turn, inductively coupled to the antenna circuit as usual at $M-4$.

Up to this point, if the transmitter T be spoken into, the antenna would radiate at three frequencies, that is, the *carrier frequency* would not be eliminated. A special balancing-out circuit, however, is provided, which is connected to the alternator $A-1$ in the following way: The input side of a vacuum tube $V-3$ is coupled to the alternator through the auto-transformer $M-3$. The output circuit of $V-3$ is connected to a phase-regulating device P , consisting of inductances, capacity and resistance, as shown. This circuit is in turn tapped across the secondary winding of the transformer $M-2$ so that currents of the carrier frequency F which may be induced in the circuits of $M-2$ are balanced out by opposite phase regulation. The antenna then radiates only during the production of the wave of vocal frequency.

PART VIII

THE DYNATRON DETECTOR AND OSCILLATOR

60. THE DYNATRON.—A recent development in the design of the three-electrode evacuated tubes is the so-called dynatron described by Dr. A. W. Hull in the February, 1918, issue of **Proceedings of the Institute of Radio Engineers.** The fundamental construction is shown in Figure 100. The tube contains a filament *F*, a perforated anode *A*, and a plate *P*. As in the usual tube circuits, the filament is incandesced

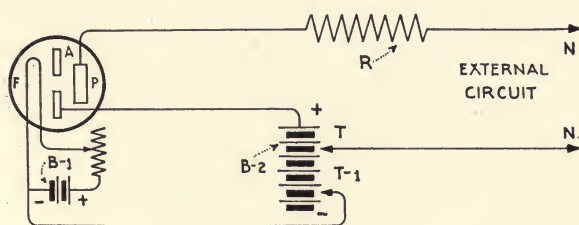

Figure 100
Showing the fundamental construction of the dynatron.

by a battery *B-1*, and the anode is held at a positive potential by the battery *B-2*.

One of the peculiar operating characteristics of the dynatron is that within a certain region of voltages applied to the plate circuit, the device

*The dynatron is treated at length in Vol. 6, No. 1, *Proceedings of the Institute of Radio Engineers*, from which the material of this chapter has been abstracted.

acts as a simple rectifier, but at other values of plate voltage it acts as a true *negative resistance*, namely, an applied E.M.F. will set up a current in the wrong direction.

When the filament F is lit to incandescence electrons are attracted to the anode A by connecting it to the positive pole of the battery $B-2$, but some of them pass through the holes in the anode and strike the plate P . If the potential difference between P and F is low, the electrons will enter the plate and as usual set up a negative current in the external

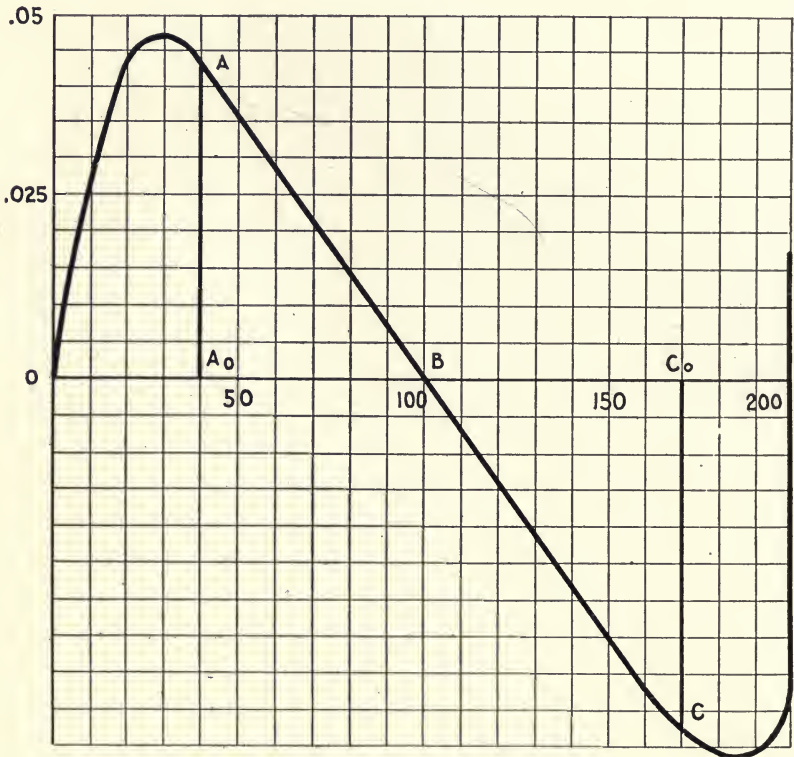

Figure 101
Characteristic curve of the dynatron.

circuit, but if the potential of P is raised to some upper value, the primary electrons will strike it with such velocity that their impact will cause the emission of secondary electrons (from the plate).

These electrons will be attracted to the more positive anode A . The final electron current received by the plate is the difference between the number of primary electrons that strike it and the number of secondary

electrons that leave it. Dr. Hull states that the number of primary electrons depends upon the temperature of the filament, but they are independent of the voltage of the plate. The number of secondary electrons increases rapidly with the voltage difference between the plate and filament and may exceed the number of primary electrons. In fact, *each primary electron may produce as many as 20 secondary electrons.*

The phenomena surrounding the functioning of the dynatron are shown in the *characteristic curve* of Figure 101. The horizontal axis represents the voltage of the plate with respect to the negative end of the filament; the vertical axis, the current in the plate circuit. The data for the plotting is secured by maintaining the filament temperature at some constant value varying the voltage of the plate to filament by moving contact *T* up the battery. Contact *T-1* serves to vary the potential of the anode. (The anode potential when properly adjusted remains fixed.)

At very low voltages, as is clear from the curve, the plate current is relatively small, but at about 25 volts the plate receives the entire electronic emission of the filament. For higher voltages the primary electronic currents remain constant, but at values above 25 volts the emission of secondary electrons enters the case; that is, the primary electrons strike the plate with such velocity as to cause the emission of secondary electrons which, as the curve indicates, increase rapidly with the voltage. The net plate current therefore decreases as may be seen by following the downward slope of the curve.

At approximately 100 volts the number of secondary electrons leaving the plate is equal to the number of primary electrons entering it. The plate current therefore is zero. For further increases of voltage, the secondary electrons exceed the primary electrons, that is, the plate experiences a net loss of electrons. *The current therefore flows in the opposite direction to the impressed voltage.* For still further increases of voltage, say 200 volts, a point is reached at which the anode is no longer sufficiently positive to carry away all the secondary electrons from the plate, and the current again becomes a zero and then rises to a number corresponding to the number of primary electrons.

It should be noted from the curve that in the region A_0 to C_0 , that is between 50 and 150 volts, the current in the dynatron decreases linearly with increase of the voltage. Here the dynatron acts as a true negative resistance. For example, if connection is made from the tap *T* and the plate *P*, the dynatron would act the reverse to an ordinary or positive resistance.

To make the *dynatron an amplifier* we insert a series resistance such as *R*, Figure 100. The value of *R* should be the same as the negative

resistance of the tube. The characteristic curve of the *total circuit* then becomes that shown in Figure 102. It is clearly seen that in the region of the plate voltage corresponding to E , the application of a small E.M.F. to the circuit of Figure 100 such as by connection to the terminals N, N , will cause a very large change in the total current through the circuit, the amplification only being limited by the characteristic curve itself. It is pointed out that while the total resistance of the circuit of Figure

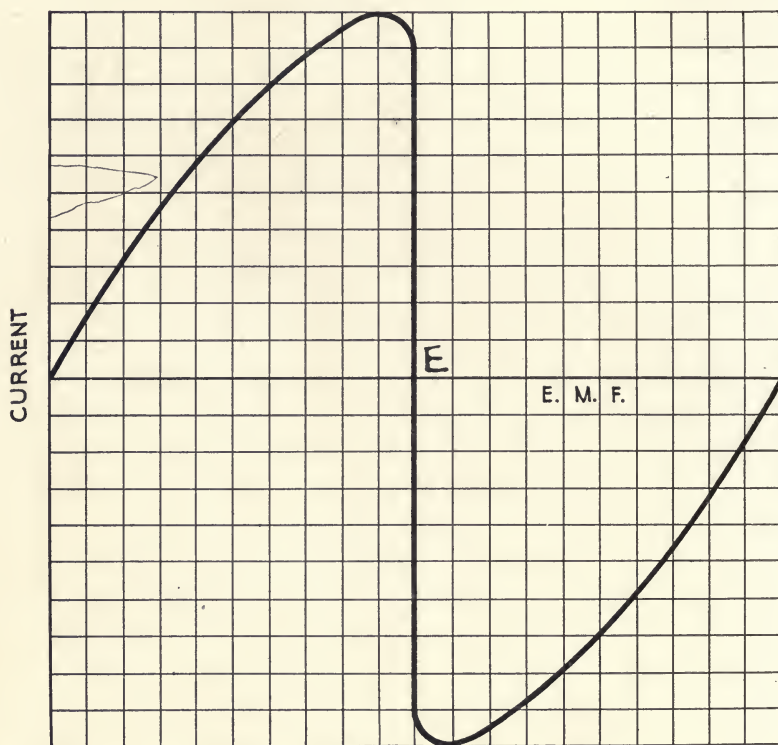

Figure 102

The characteristic curve of the dynatron for voltage amplification.

100 is very small, the resistance of its parts individually is not. Therefore, a small change in applied E.M.F. will cause a comparatively large change in current and consequently in the voltage drop across each part separately. The dynatron thus becomes a powerful amplifier.

61. THE DYNATRON AS AN OSCILLATOR.—The plate circuit of the dynatron if connected to an inductance-capacity circuit will oscillate at a frequency determined largely by the values of L and C . Such a circuit is shown in Figure 103, where the inductance L is shunted

by the condenser *C*, both being connected in series with the circuit of the plate *P*. Since there is but one oscillating circuit it affords greater simplicity in manipulation than the usual regenerative systems. Connected as in Figure 103 the dynatron may be employed to generate the local radio frequency currents for beat reception or for radio frequency measurements. Currents at frequencies from one-half to 20,000,000 cycles per second are readily obtained.

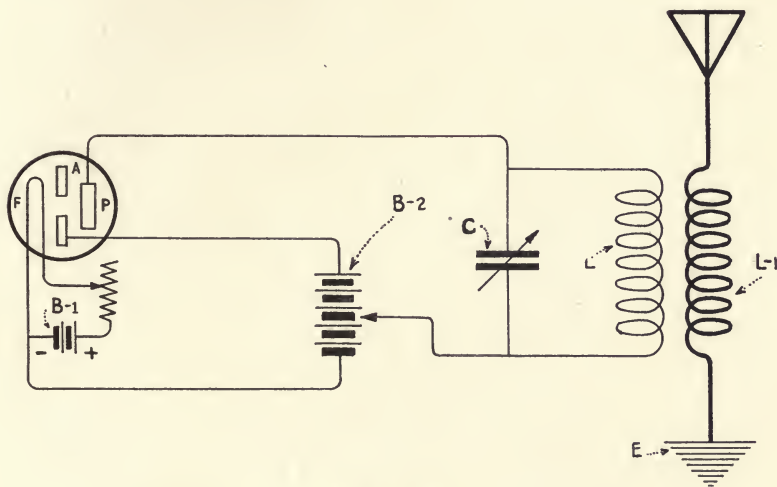

Figure 103

The connections of the dynatron for the production of radio frequency currents.

62. THE DYNATRON AS A DETECTOR OF ELECTRICAL OSCILLATIONS.—If connected as in Figure 104, the dynatron can be employed to detect electrical oscillations in radio. For example, if the plate potential is adjusted by moving the sliding contact *T*, Figure 100, over the high voltage battery *B-2* we arrive at the points *C* or *A* in Figure 101. The radio frequency current impressed upon the plate circuit, which in this case includes the secondary inductance *L-2*, the shunt condenser *C-2*, the telephone *P-1* and the shunt condenser *C-1*, will, if the dynatron is worked near either point *A* or *C*, be repeated through the telephone with *distortion*; that is, there will be obtained a radio frequency component of the plate current the increase of which exceeds the decrease, *i. e.*, a rectification. The telephone, therefore, will be impulsed once for each group of incoming oscillations. The distributed capacity of the telephone winding *P-1* will be sufficient to pass the radio frequency current flowing in the secondary circuit, but owing to the high inductance of the telephone windings the circuit is apt to oscillate at an audio fre-

quency. Audio frequency oscillation may be prevented by shunting the telephone to a condenser $C-1$ of suitable capacity.

The circuit of Figure 104 may be set to oscillate at a frequency slightly different than that of the incoming signals thereby producing beats. Further advantage can be obtained by tuning the circuit including the telephone $P-1$ and the condenser $C-1$ to the desired audio frequency. This is accomplished by adjusting the capacity of $C-1$ and the negative resistance of the tube to neutralize the resistance of the telephone $P-1$ to a particular audio or group frequency. If the frequency of the circuit coincides with the group frequency of the incoming oscillations, the sensitiveness of the system becomes very great.

In a circuit of this kind, the energy consumed in the detector does not decrease the amplification because the dynatron can be adjusted just to neutralize this loss. The selectivity is therefore relatively great, for the detector absorbs no energy as in circuits heretofore; *i. e.*, the damping is not increased by the detector.

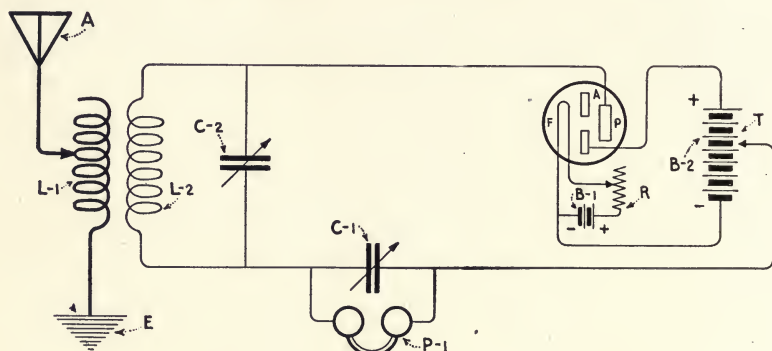

Figure 104

Connections of the dynatron as an oscillation detector in radio.

63. THE DYNATRON AS A COMPENSATOR FOR CIRCUIT LOSSES.—Two circuits disclosed by Dr. Hull show how the dynatron may be employed to supply the energy losses in any oscillation circuit. The circuit therefore behaves as regards selectivity, damping and sensitiveness, to an impressed radio frequency current like a circuit having zero resistance, that is, the dynatron feeds back to the circuit that energy which ordinarily is lost by "positive" resistance. In the diagram of Figure 105, the *dynatron is connected in the plate circuit of a three-electrode tube for aperiodic amplification*. The filament of the three-electrode tube is shown at F , the grid at G , and the plate at P . The dynatron is indicated by the filament F' , the anode A' , and the plate P' .

The filament F is incandesced by the battery $B-1$, the filament F' by the battery $B-2$, and the anode of the dynatron is held at a positive potential by the battery $B-3$. Battery $B-4$ is that normally of the plate circuit P , but it includes the resistance R and the current translator $P-1$, R being adjusted just to neutralize the negative resistance of the dynatron F', A', P' . The current through the pliotron and for constant grid voltage in creases with increasing voltage of the plate, that is, the circuit has the characteristics of a positive resistance which limits its amplifying power, but this may be neutralized by connecting the dynatron as shown in Figure 105.

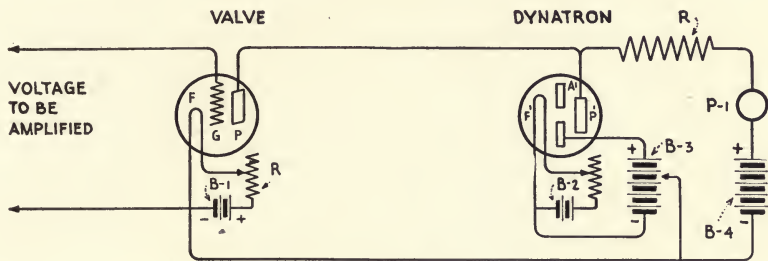

Figure 105

The dynatron connected to compensate for the losses in the plate circuit of a three-electrode vacuum tube.

Using a pliotron of 100,000 ohms resistance and a series resistance, R , of 250,000 ohms, Dr. Hull states that the D. C. voltage amplification was increased from 12 fold for the pliotron to 625 fold for the circuit of Figure 105.

The dynatron connected to compensate the *grid circuit losses* of a *pliotron* is shown in Figure 106. An increase of the voltage of the grid

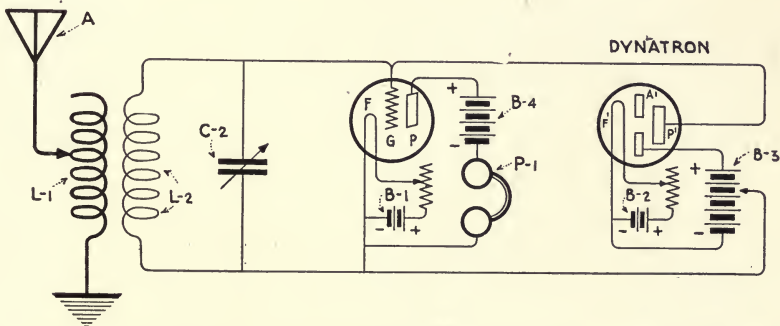

Figure 106

The dynatron connected to compensate for the losses in the grid circuit of a three-electrode vacuum tube.

of the pliotron detector is opposed by a leakage current which increases with the voltage as in a positive resistance, and also by the counter E.M.F. and losses in its own and coupled antenna circuit. These losses may be neutralized by connecting a dynatron in parallel with the grid circuit of the pliotron as in Figure 106. It is remarked that with this arrangement the intensity of weak signals from a spark set was increased from audibility to a roar.

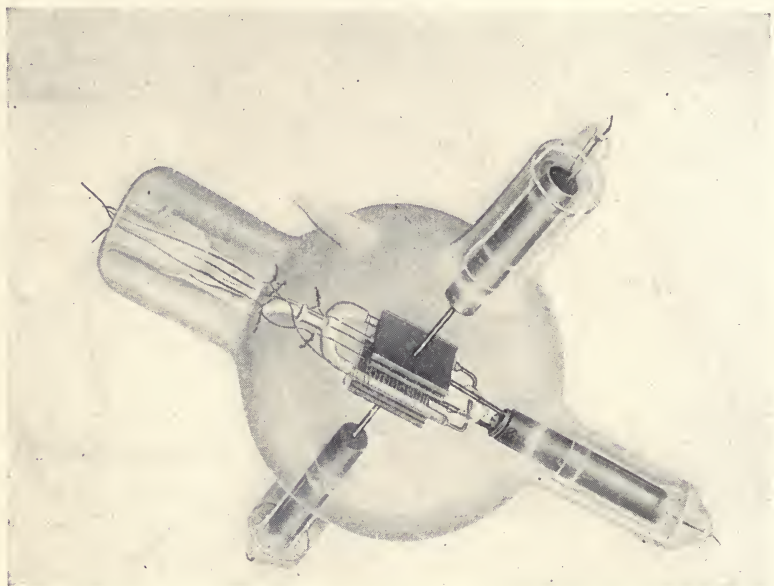

Figure 107
The pliodynatron.

64. THE PLIODYNATRON.—As in the usual three-electrode tube, the electrostatic field of a grid may be employed to control the number of electrons reaching the plate in a dynatron. A tube constructed in this way, shown in Figure 107, is called a *pliodynatron*. Its construction is in all respects similar to the simple dynatron with the exception of the grid surrounding the filament.

The negative resistance of the pliodynatron makes it a powerful amplifier. In the simple pliotron an increase of grid potential by increasing the current through the load in the plate circuit and therefore the voltage drop over the load lowers the voltage of the plate and this tends to decrease the plate current and to oppose the effect of the grid. In the pliodynatron, a decrease in the plate voltage means an increase in

current which may be very large if the positive and negative resistances are adjusted equally.

65. THE PLIODYNATRON AS A DETECTOR.—The circuit for the pliodynatron as a detector of radio frequency currents is shown in Figure 108, the primary winding of the receiving tuner being indicated at *L-1*, the secondary winding at *L-2*, the shunt condenser at *C-1*, the grid element at *G*, the filament at *F*, the anode at *A*, and the plate at *P*. The filament is incandesced by *B-1* and the anode is excited by the battery *B-2*. The potential of the plate *P* in respect to the anode is regulated by the variable contact *T* at the battery *B-2*. The plate circuit in-

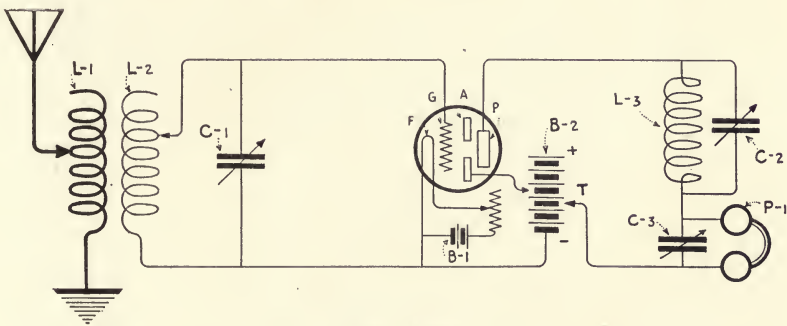

Figure 108

The connections of the pliodynatron as a detector of radio frequency currents.

cludes the inductance *L-3*, a shunt condenser *C-2* and the telephone condenser *C-3*. The function of the circuit *L-3*, *C-2*, is to increase the selectivity of the circuit or to amplify the incoming signal. Thus the circuit *L-3*, *C-2*, may be set on the verge of oscillation for the reception of *damped waves*, or set into oscillation at a slightly different frequency than that of the incoming signal, for the reception of *undamped waves*. Used in the latter way, beats will occur in the plate circuit. The circuit *P-1*, *C-3*, can be tuned to the beat frequency for greater selectivity. This circuit can be brought to the verge of oscillation at an audio frequency by adjusting the negative resistance. The final adjustment for radio frequency tuning is made by varying the ratio of *L-3* to *C-2*, keeping their product constant for any particular applied frequency.

66. THE PLIODYNATRON IN RADIO TELEPHONY.—The pliodynatron may be employed to generate the required radio frequency current for radio telegraphic or telephonic transmission, as has already been shown in Figure 103. The circuit for radio telephony is shown in Figure 109. The primary circuit *L-1*, *C*, is inductively coupled to the

antenna through coils L , $L-1$. Owing to the instability of a circuit possessing negative resistance, oscillations will occur in the circuit $L-1$, C , at a frequency varying as their product. The amplitude of these oscillations may be controlled by the grid G , which is connected to one leg of the secondary winding of a speech frequency transformer. The other leg of this transformer is connected to one terminal of the plate battery

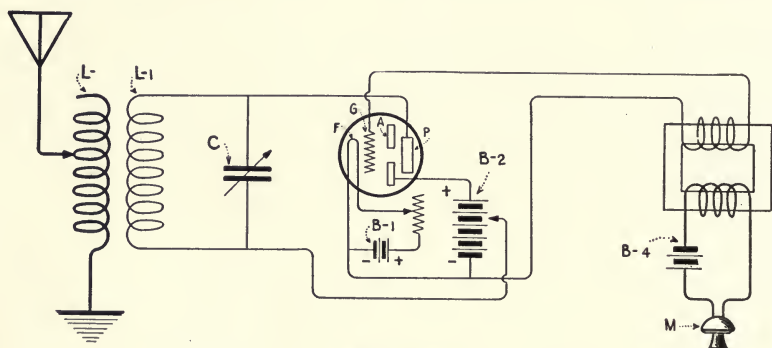

Figure 109

The connections of the pliodynatron in wireless telephony.

$B-2$. A microphone M and a battery $B-4$ cause speech frequency variations of the potential of the grid to the filament and the amplitude of the energy radiated from the antenna is varied in accordance.

Dr. Hull reports that with a small tube giving about ten watts it became possible to telephone by wireless sixteen miles with good intensity and articulation.

APPENDIX

Diagrams Illustrating Certain Fundamental Actions of the Vacuum Tube as an Oscillation Detector In Radio Telegraphy

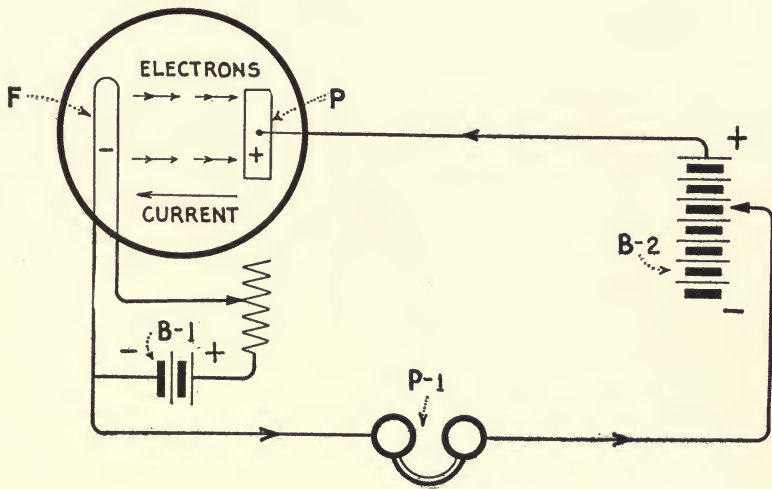

Figure 1

The filament F when heated by battery B-1 emits electrons which are drawn to plate P when it is connected to the positive pole of a high voltage battery such as B-2. Current from battery B-2 then flows from P to the negative side of F through the telephones back to the negative terminal of the battery. (It is to be noted that the assumed direction of the current is opposite to the flow of electrons.)

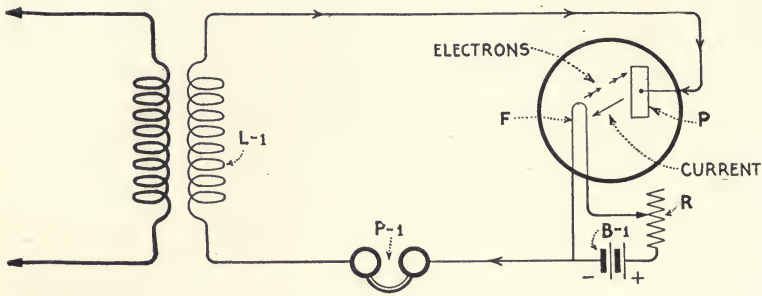

Figure 2

If filament F and plate P are connected to the terminals of a coil L-1 in which is induced an alternating E.M.F. the valve is conductive in the direction from P to F but not in the opposite way. Hence the alternating current induced in coil L-1 is rectified and the telephone P-1 is traversed by uni-directional currents.

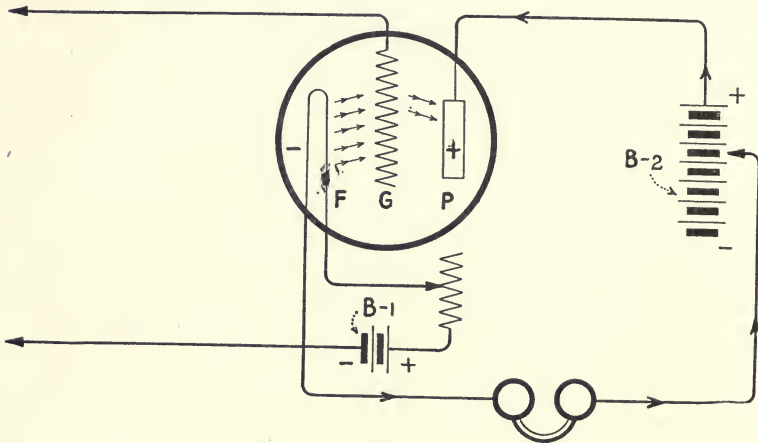

Figure 3

If a metallic element called the grid, G, is inserted between the filament and plate it captures a certain number of electrons and its potential is lowered thereby reducing the flow of current from P to F. In other words, the flow of current from B-2 is reduced.

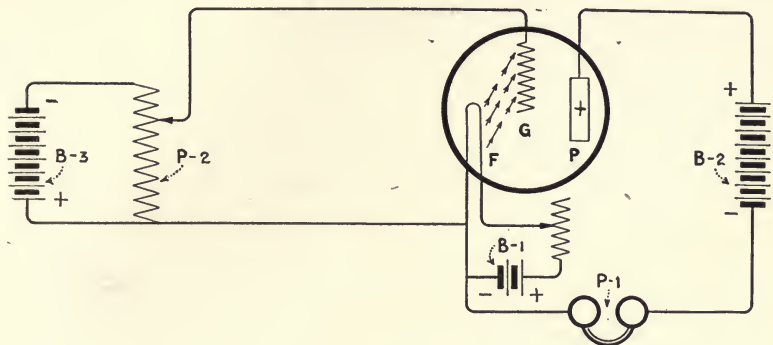

Figure 4

If the grid, G, is charged to a sufficiently high negative potential relative to the filament by an external E.M.F. such as may be supplied by a battery B-3, the flow of electrons from the plate is completely obstructed. The circuit of the battery B-2 from P to F is then opened.

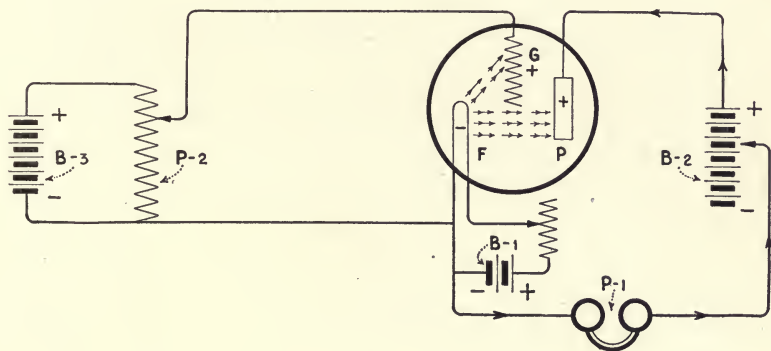

Figure 5

If the grid G is charged to a positive potential by an external E.M.F. normal flow of electrons to the plate takes place and the circuit of battery B-2 is restored.

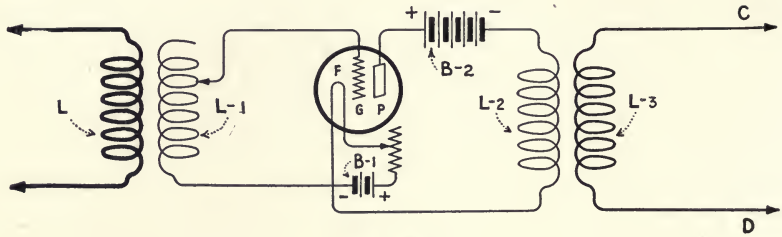

Figure 6

If the terminals of a coil such as L-1 are connected to the grid, G, and the filament, F, and an alternating E.M.F. of radio or audio frequency is induced therein, the negative alternation reduces the flow of electrons between F and P and the positive alternation increases the flow of electrons between F and P. The plate current therefore rises and falls at the frequency of the E.M.F. impressed upon the grid circuit. An alternating current of increased power can then be withdrawn from the terminals C, D, of the coil L-3. The additional energy for amplification is supplied by the source B-2. Within a certain range of applied E.M.F.'s. the current impressed upon the grid circuit will be repeated in the plate circuit B-2, L-2 without distortion. On the other hand, under certain adjustments of filament temperature and plate voltage, what amounts to a rectified current will flow through the coil L-2 when an alternating E.M.F. is impressed upon the filament F and the grid G; that is, the positive halves of the repeated plate currents may exceed the negative halves or vice versa.

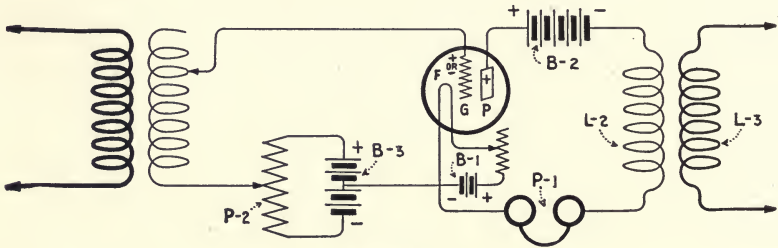

Figure 7

By inserting a grid battery B-3, shunted by the potentiometer, P-2, in the grid circuit of the valve F, G, the potential of the grid in respect to the filament can be maintained so that the negative half of an impressed alternating E.M.F. causes a very slight reduction of the plate current and the positive half a great increase of the plate current. This effect is obtained when the tube is worked at the lower bend of the characteristic curve. At the upper bend, the reverse effect takes place, that is, the negative half of an impressed alternating E.M.F. decreases the plate current greatly, and the positive half increases it slightly. In either case, what amounts to a rectified current flows in the plate circuit P, B-2, L-2, P-1, F. The same effect is obtained from the circuit in Figure 6, but with the potentiometer and battery of Figure 7 it is less difficult for the operator to obtain the desired operating characteristic.

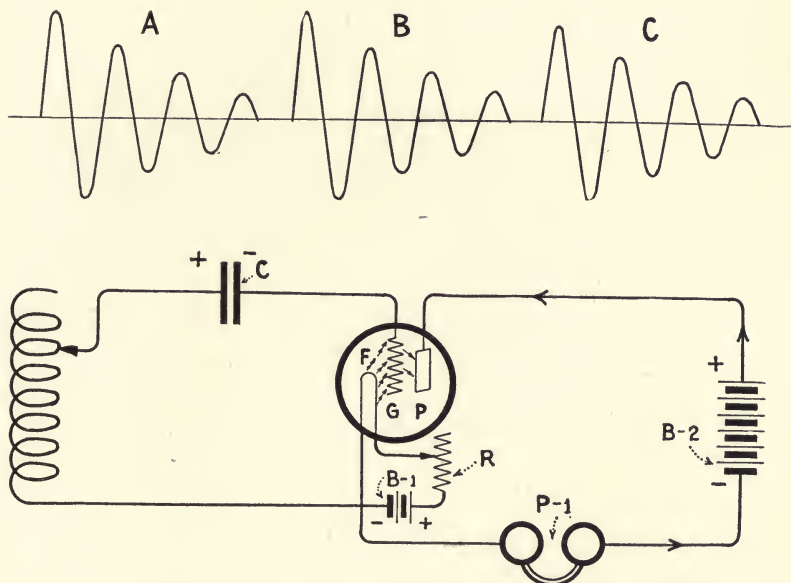

Figure 8

By connecting a condenser C in series with the grid, groups of radio frequency oscillations such as A, B, C are rectified between G and F, the condenser C accumulating a charge which is negative on the grid side of C. This increased negative potential reduces the electron current from filament to plate, that is, the flow of current from battery B-2 is reduced. At the termination of a group of grid oscillations the charge leaks out the condenser C, either through the valve or through a special leak resistance. The grid then returns to normal potential, and the plate current returns to normal value. The telephone P-1 will then be impulsed once for each group of radio frequency oscillations. During the time that the radio frequency oscillations undergo rectification, the radio frequency current impressed upon the grid circuit is repeated in the plate circuit, but this current is not heard in the telephone P-1 because its frequency is above audition.

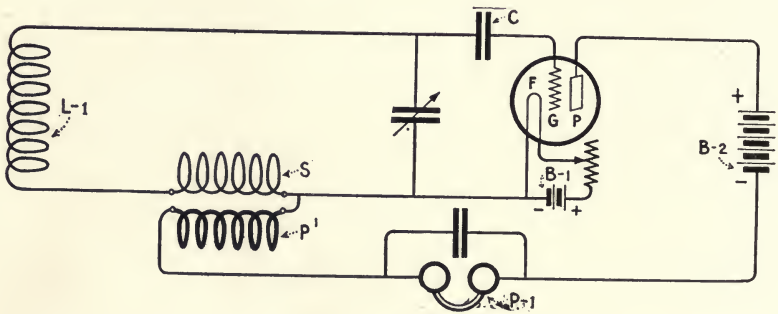

Figure 9

By coupling the plate and grid circuits of the vacuum tube through a transformer such as P', S either the radio or audio frequency variation of the continuous plate current (such as is obtained during the reception of wireless signals) can be impressed upon the grid and re-enforced; that is, part of the energy in the plate circuit is fed back to the grid circuit for amplification. If it is desired to amplify radio frequencies, transformers P', S , is an air core radio frequency transformer, but for the amplification of audio frequencies, windings P' and S may have a henry or more inductance and be provided with an iron core. A circuit of this kind is termed a regenerative system. Incoming radio signals may thus be enormously amplified.

If the coupling of P' to S is sufficiently close, the valve will be set into self-oscillation at a radio or an audio frequency. The tube thus becomes a generator of sustained oscillations which may be employed for transmission of radio telephonic or telegraphic signals, or for the reception of continuous waves by the phenomenon of beats or otherwise.

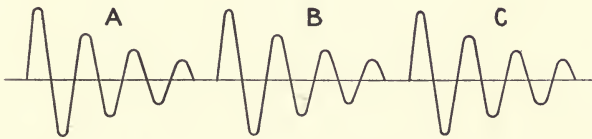
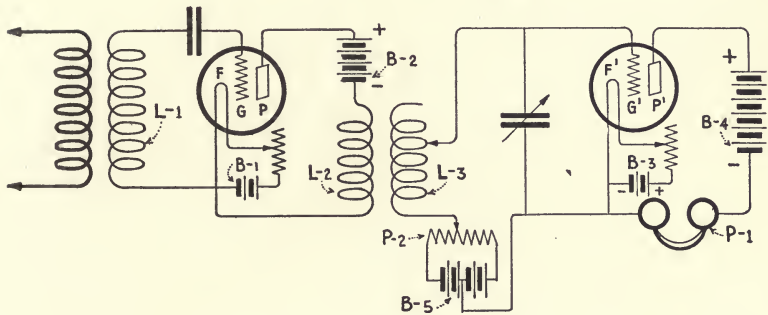

Figure 10

If groups of radio frequency oscillations, such as A, B, C, are impressed upon the coil L-1, the plate circuit including the coil L-2 is traversed by an audio and a radio frequency current. Either the audio or radio frequency component of the continuous plate current can be amplified by coupling L-2 to the grid circuit of a second valve F', G' P' through coil L-3. If the audio frequency component is to be amplified, L-2, L-3 is an iron core transformer of audio frequency dimensions; but if it is desired to amplify the radio frequency component of the continuous plate current, transformer L-2, L-3 is of the air core type and of radio frequency dimensions. Several tubes may be connected in this way for further amplification. Cascade amplifiers are used in wire telephony for the amplification of long-distance telephone signals as well as in radio. In fact, the tubes may be employed to amplify the input of any variable wave form.

REVIEW QUESTIONS

INTRODUCTION

- Ques. (1) State the distinction drawn between audio and radio frequency currents.
- Ques. (2) How may radio frequency currents be made audible in a telephone receiver?
- Ques. (3) State three methods by which continuous oscillations may be made audible in a telephone.
- Ques. (4) If a single group of radio frequency oscillations are rectified by an oscillation detector, what is the effect upon the telephone diaphragm?
- Ques. (5) What are the two fundamental circuits of the inductively coupled receiving tuner?
- Ques. (6) How is the receiver transformer and associated tuning apparatus adjusted to establish resonance with the distant transmitter?
- Ques. (7) Over what range of frequencies will the telephone receiver give maximum response with a minimum of current?

PART I

- Ques. (1) What is the direction of the electron current within the two-electrode tube?
- Ques. (2) Explain by diagram a simple test by which the rectifying properties of the tube can be demonstrated.
- Ques. (3) Explain what is meant by the non-uniform conductivity of the vacuum tube; how can advantage be taken of the tube's non-uniform conductivity in the reception of radio signals?
- Ques. (4) Explain the phenomena of the tube which cause it to reach the point of saturation.

PART II

- Ques. (1) Show by diagram three practical circuits for the two-electrode valve as an oscillation detector in radio.
- Ques. (2) What is the effect of inserting the grid element in a two-electrode vacuum tube?
- Ques. (3) If the grid is charged to a high negative potential by an external E.M.F., how does it affect the electron current; similarly what is the effect if the grid is charged to a positive potential?
- Ques. (4) If an alternating E.M.F. be impressed upon the grid and filament of the three-electrode tube, state what occurs in the plate circuit?
- Ques. (5) Explain the functioning of the three-electrode valve as an oscillation detector with a grid condenser.
- Ques. (6) Explain the action of the three-electrode tube as an oscillation detector without the grid condenser.
- Ques. (7) What adjustments are necessary in order that the three-electrode tube may be employed as a distortionless repeater?
- Ques. (8) How can the three-electrode tube be adjusted to set up a rectified current in its plate circuit?
- Ques. (9) What is the effect of tuning the plate circuit of the three-electrode tube?
- Ques. (10) Explain what is meant by the "input" and "output" circuits of the vacuum tube.

PART III

- Ques. (1) Explain what is meant by a cascade connection of vacuum tubes.
- Ques. (2) What are the principal points of difference between the cascade radio frequency amplifier and the cascade audio frequency amplifier?
- Ques. (3) Which of the two cascade systems (radio or audio frequency) gives the greatest selectivity?

PART IV

- Ques. (1) What is the effect of regenerative coupling in the vacuum tube system?
- Ques. (2) Explain how the radio frequency regenerative amplifier is adjusted to amplify damped oscillations?

- Ques. (3) What are the differences between the audio frequency regenerative amplifier and the radio frequency regenerative amplifier?
- Ques. (4) Show by diagram a circuit employing electrostatic regenerative coupling.
- Ques. (5) If during the reception of radio signals the incoming currents are repeated without distortion in the plate circuit, how can the repeated plate currents be made audible in the telephone?

PART V

- Ques. (1) What are the advantages of a combined regenerative and cascade amplification system?
- Ques. (2) For selectivity, which is preferable, the audio frequency regenerative cascade system or the radio frequency regenerative cascade system?

PART VI

- Ques. (1) State three methods by which continuous oscillations may be made audible in the head telephone.
- Ques. (2) Explain the fundamental theory of the beat receiver.
- Ques. (3) What are the advantages of the beat receiver over the tikker?
- Ques. (4) Show by diagram and explain the functioning of the external-heterodyne receiver and the self-heterodyne receiver.
- Ques. (5) Explain how the circuits of the three-electrode tube can be set into oscillation at a radio frequency.
- Ques. (6) Show the circuits of an audio frequency tuning system.
- Ques. (7) What are the advantages of an audio frequency tuner?
- Ques. (8) Show by diagram how continuous waves may be detected by the vacuum tube without employing the beat phenomenon.
- Ques. (9) What are the advantages of a cascade regenerative system for beat reception?
- Ques. (10) Why is amplification obtained through the use of open circuit oscillators?
- Ques. (11) Show by diagram how the three-electrode tube may be connected up for the generation of radio or audio frequency currents.

PART VII

- Ques. (1) Explain three methods by which the antenna currents of a radio telephone transmitter may be modulated at a vocal frequency.
- Ques. (2) In what part of the circuits of the three-electrode vacuum tube is the connection of the microphone transmitter most effective for modulation?
- Ques. (3) Show by diagram how the vacuum tube may be connected up for the production of radio frequency oscillations and include a battery of tubes for the amplification of their output.
- Ques. (4) Show by diagram how the carrier wave in radio telephony can be eliminated except at such times as the microphone is actuated.

PART VIII

- Ques. (1) What are the fundamental points of difference between the construction of the dynatron and the three-electrode vacuum tube?
- Ques. (2) Show the circuits of the dynatron for use as a detector of electrical oscillation.
- Ques. (3) Show the circuits of the pliodynatron as an oscillation detector in radio.
- Ques. (4) Explain the operation of the dynatron as an oscillation detector from its characteristic curve.

INDEX

	Page		Page
A MPLIFIER		E LECTRON	
cascade audio frequency..57, 58, 159		definition of	20, 21
cascade radio frequency.....51, 52		F LEMING, DR. J. A.....	19
combined radio and audio fre-		Fleming Oscillation Valve....	21, 37
quency cascade.....	61	action of simple.....	29
curves of cascade.....	55, 56	non-uniform conductivity of...	24
regenerative vacuum valve..	62, 76	practical circuits for..	33, 34, 35, 36
Armstrong, Capt. E. H.....	19	rectifying properties of.....	23
Audio frequency tuning...100, 101, 102		saturation characteristic of....	26
Audio and radio frequency currents		space charge of.....	28
definition of	1	temperature limitation of...27, 28	
B EAT CURRENTS.....	5	Franklin's "Reaction" Circuits....	73, 74
Beat Receiver		H ETERODYNE RECEIVER	
curves of	90, 91	amplification by.....	119, 120, 121
phenomena of.....	86, 87, 88	selectivity by the.....	91, 92
regenerative type of.....	97, 98	simple type of.....	88, 89
theory of.....	84, 85, 86	with vacuum valve, as detec-	
Beat Reception from damped wave		tor	92, 93
transmitters	113	I NDUCTANCE	
C ASCADE AMPLIFICATION..	108	multipoint tuning.....	13
Coils, multilayered type of....	12	Ions, positive and negative.....	20
Continuous oscillations, detection of	5	K ENOTRON	122, 123
Continuous waves		connections for	126
reception of.....	82, 83, 84	L ANGUMUIR, DR. IRVING....	19
reception of, without beats.103, 107		O SCILLATIONS, ELECTRICAL	
reception of, by rotary con-		damped and undamped.....	2
denser	114, 115	detection of continuous.....	5
D ETECTOR, OSCILLATION		Oscillators, open circuit....	116, 117, 118
coherer	4	P LATE CURRENT	
dynatron	156	radio and audio frequency com-	
Fleming	21	ponent of	48
Marconi magnetic.....	4		
pliodynatron	159		
slipping contact type of.....	5		
three-electrode	37		
two-electrode	22		
Dynatron			
as an amplifier	154		
as an oscillator	155		
as a detector	155, 156		
as a compensator of energy			
losses	157, 158, 159		

Page

Pliotron	123, 124, 125
as generator of high voltage at radio frequencies	127, 128
as generator of heavy currents at radio frequencies.....	125, 126
connections for	126
Pliodynatron	
as a detector.....	159
in radio telephony.....	159, 160

RECEIVER

modified Weagant undamped wave	103, 104
telephone, phenomena of	
1, 15, 16, 17	
Weagant undamped wave..	102, 103
Receiver Circuits	
conductive type of.....	10
electrostatically coupled type of	10
inductive type of.....	9
open oscillator type of.....	11
Receiver Telephone	15
action of	16, 17
Regenerative Amplifier	
Armstrong's	
63, 64, 65, 66, 67, 68, 69, 70, 71, 72	
audio frequency	69
combined audio and radio frequency	70
electrostatic and direct magnetic coupling for.....	70, 71
simple type of.....	75, 76
ultra-audion	72
Regenerative Cascade Systems..	77, 78, 79
audio frequency	80
Regenerative Cascade Systems for beat reception....	109, 110, 111, 112
Rectifiers	
types of	3
use of	3
S ELECTIVITY IN RADIO RECEIVERS	14
Self-heterodyne	
phenomena of the.....	99

Page

TUNING

necessity for	11
Tuned Plate Circuit.....	49, 50
Armstrong's	66, 67, 68
Transmitter	
radio frequency circuits of....	12

VALVE, THREE-ELECTRODE

characteristic curve of	
38, 39, 43, 44, 48, 49	
as an electron relay.....	41
as generator of radio frequency oscillations	95
apparatus for obtaining characteristic curve of.....	40
fundamental construction of...	37
modified open circuit, oscillators for	118
open circuit, oscillators for..	116, 117
rectification by	47
relaying action of.....	44
terminology of.....	41
use of, with grid condenser...	45

WAVE SYSTEMS

distinction between continuous and discontinuous	
Weagant, Roy A.....	19
Wireless Telephony	
Englund's system for	
135, 136, 137, 138, 146	
147, 148, 149, 150	
Espenschied's duplex system for	140, 145
Carson's system for.....	139
Hund's system for.....	134, 135
Simple circuits of three-electrode tube for..	131, 132, 133, 134

"X" CIRCUIT RECEIVER

R. Weagant	102, 103, 104
-----------------	---------------

MEMORANDA

MEMORANDA

MEMORANDA

MEMORANDA

Advanced Instruction Provided for RADIO MEN at the MARCONI INSTITUTE

The *only completely equipped* Radio Training School
in the United States

Prospective Aviators are trained on modern airplane sets.

Prospective Naval Recruits have the opportunity of testing and manipulating modern submarine sets.

Commercial Operators are instructed on transmitters of the most modern types in use in the year 1918.

Advanced Classes in the theory and practical operation of vacuum tubes.

*Cascade radio and audio frequency amplifiers
and beat receiver apparatus in daily use*

Over 4000 Graduates to date

Classes for *radio specialists* forming from time to time.

Our code instruction rooms are unusually complete. Individual instruction given to beginners by special tutor. Wheatstone automatic transmitter and code instruction records in daily use.

The principle and theory of continuous Wave Transmitters and Receivers are comprehensively covered.

We can accommodate nearly 600 students in the New York School and several hundred additional students in our branch schools.

An illustrated 96-page MANUAL covering the entire wireless field, free upon request

Call, telephone or write to Director of Instruction

MARCONI INSTITUTE, Edison Building
25 ELM STREET **New York City**

The **Extension Service** of the Institute provides Radio men with the latest information of the art and aids them to solve specific problems through direct correspondence.

BRANCH SCHOOLS:

Room 361-70, Lenox Bldg., Euclid Ave. and East 9th St., Cleveland, Ohio
New Call Building, New Montgomery Street, San Francisco, Cal.

Addresses of other branch schools to be announced later

THE WIRELESS AGE

offers a series of

Practical Training Courses

in the following branches, of which there is urgent need.

Aviation—Conducted by HENRY WOODHOUSE, Governor of the Aero Club of America

Principles and theory of flight—nomenclature, assembly, rigging,—care and repair of aeroplanes—operation and care of aeronautical engines—principles of general and cross-country flying—reconnaissance, map reading, signaling and co-operation with military bodies—radio for aircraft and its uses—machine gunnery and bombing from aeroplanes.

Signal Corps Work—Conducted by Major J. ANDREW WHITE, Chief Signal Officer, Junior American Guard

Function and operations of the Signal Corps and its relation to the line of the army—drill instruction, mounted and dismounted, for telegraph companies, radio and outpost companies, and battalions of Signal Corps—signaling by telegraph, heliograph, night lantern and flags, radio and service buzzer—camp and field telephones and their uses—radio apparatus of the Signal Corps—scouting, patrolling and tactical employment of field lines.

Wireless Telegraphy—Conducted by ELMER E. BUCHER, Instructing Engineer, Marconi Wireless Tel. Co.

Code practise—elementary electricity and magnetism—primary and secondary batteries—electrical units and circuits—electromagnetism—electromagnetic induction—the dynamo, motor and motor generator—transmitting and receiving apparatus—transformers—tuning—modern wireless sets—measurements—undamped oscillation transmitters and receivers—regenerative receiving circuits.

Navigation—Conducted by Capt. F. E. UTTMARK, Principal, Uttmark's Nautical Academy

Compass work—details of Mercator's chart—coastwise and ocean chart sailing—keeping the log book—the taffrail and chip logs—dead reckoning—care and use of the sextant and chronometer—correcting altitudes and declination—latitude by meridian observation of the sun—selection and use of logarithms—various kinds of time—longitude by solar sights—deviation of compass by sun azimuths, and by terrestrial ranges.

These courses are conducted exactly as lecturers give them to their classes.

The printed diagrams and charts take the place of regular blackboard exercises, and the text, covering description, principles and application, progresses step by step through elementary instruction, apparatus and practical operation.

The cost of similar instruction in regular training schools would be—

Aviation	\$75.
Signal Corps Work	\$75.
Wireless Telegraphy	\$65.
Navigation	\$100.

Total.....\$315.

Offered in THE WIRELESS AGE for \$2.00.

SPECIAL CLUB RATES FOR CLASSES, ASSOCIATIONS AND SOCIETIES

If you are enlisted, eligible for enlistment or interested in any young man who would be benefited by a knowledge of the fundamentals of any one of these branches of skilled and remunerative work

SUBSCRIBE TODAY

Issued Monthly. \$2.00 per year. Foreign postage 48c extra.

WIRELESS PRESS, Inc.

25 ELM STREET

NEW YORK

PRACTICAL WIRELESS TELEGRAPHY

By **ELMER E. BUCHER**

Instructing Engineer of the Marconi Company

Revised Edition, enlarged, with new chapter on Location
of Trouble—Maintenance—Repairs

This book is the last word in wireless text books. It furnishes much information of utmost value in regard to the very latest styles of wireless sets now in use, and which has not appeared in print before.

PRACTICAL WIRELESS TELEGRAPHY is the first wireless text book to treat each topic separately and completely, furnishing a progressive study from first principles to expert practice. Starting with elementary data, it progresses, chapter by chapter, over the entire field of wireless—fundamentals, construction and practical operation.

Three chapters are devoted entirely to basic electrical principles. The motor-generator, the dynamotor and rotary converter are treated in detail. The nickel-iron and lead plate storage batteries, now supplied for emergency purposes with all commercial radio equipments are the subject of an entire chapter, a description of the apparatus associated with the charging of batteries and complete instructions for their care being furnished.

The radio transmitter is treated both in theory and in practice. The book contains complete diagrams, photographs and descriptions of modern commercial marine transmitters and instructions for the adjustment and operation of the apparatus. Receiving apparatus is treated in like manner, descriptions and working instructions being given for all types of up-to-date receiving sets, including the two and three-electrode valves.

A full chapter is devoted to practical radio measurements, showing in detail

how to tune a transmitter and receiving set, how to measure inductance and capacity of radiotelegraphic circuits, how to determine the strength of incoming signals and the method of plotting resonance curves. A complete explanation of ships' tuning records, Government tuning cards and everything pertaining to the adjustment of a wireless telegraph transmitter and receiver is published.

The emergency transmitters and auxiliary power apparatus of modern ship wireless sets are thoroughly described and illustrated. Descriptions in detail and principle of the Marconi direction finder are given and modern undamped wave transmitters and receivers are comprehensively told of.

The student, for the first time, is given a complete description of Marconi transoceanic stations, including their fundamental working principles, the details of the apparatus and the general plan of the great globe-girdling scheme of the Marconi system.

The 340 illustrations alone, specially drawn, form a complete diagrammatic study and impress upon the reader's mind a pictorial outline of the entire subject. Many of these illustrations reveal details of construction of the newest types of sets and apparatus never before published.

PRACTICAL WIRELESS TELEGRAPHY is a practical man's book from cover to cover and up to the minute. Size 330 pp. 6 x 9 inches, handsomely bound in full cloth with cover stamping in gold and black.

Price \$1.50 net. Mailing weight 2 lbs.

Postage as per Postal Rate schedule.

This volume has been a very expensive one to prepare. Ordinarily it would be priced at \$2.50, but to meet the requirements of students and amateurs for a moderate priced, up-to-date text the lower price has been fixed.

Specialists in
Wireless Literature

Wireless Press, Inc. 25 ELM ST.
NEW YORK, N. Y.

At Last—a Practical Book for Aviators
Practical Aviation for Military Airmen

By MAJOR J. ANDREW WHITE

*Author of "Military Signal Corps Manual."
Chief Signal Officer, American Guard.*

A complete text for intensive study. It provides all fundamental information required to prepare an aviator for actual flying. Each component part of the airplane is shown by diagram and principles and methods of operation are concisely stated in detail therewith. It treats broadly many subjects not covered in general aeronautic text books.

CONTENTS

Principles of flight; construction of the airplane; rigging; directions for first flights, cross-country and night flying; construction, operation and care of engines; reconnaissance, map reading, signaling and co-operation with military bodies; radio and its uses; machine gunnery and bombing from airplanes, etc.

Cloth, Price \$1.50

Ready About September First

How to Pass U. S. Government Wireless License Examinations

By E. E. BUCHER

New Edition Largely Revised and Extended. 142 Questions and Answers

An ideal quiz book when used with PRACTICAL WIRELESS TELEGRAPHY

CONTENTS

Explanation of Electrical Symbols—Definitions of Electrical Terms—Part I. Transmitting Apparatus—Part II. Motor Generators—Part III. Storage Batteries and the Auxiliary Set—Part IV. Antenna of Aerials—Part V. Receiving Apparatus—Part VI. Radio Laws and Regulations—Part VII. General Information Concerning Operator's License Examinations—Practical Equations for Radio Telegraphy—Equations for Ordinary Power Work.

PRICE 50c. Net

Elementary Principles of Wireless Telegraphy

By R. D. BANGAY

Since the book has been used largely in the training of Telegraphists who are frequently called upon to take sole charge of complete Wireless Telegraph installations, the author has endeavored to cover all parts of the transmitting and receiving apparatus in such a way as to give the student a sound working knowledge of the apparatus entrusted to his care.

CONTENTS

Continental Code—Symbols Used in Diagrams—Electricity and Magnetism—Magnetism—The Principles of Wave Motion—Pressure Waves—Production of Waves—Production of High-Frequency Oscillations—Production of Oscillating Currents in an Aerial—Coupled Oscillatory Circuits—The Wavemeter—Wireless Telegraph Receivers—The Tuning Buzzer—The Electrolytic Detector—The Magnetic Detector—"Atmospherics"—Aerials—Distribution of Potential and Current Along Aerials—Masts—The Insulation of Aerials—INDEX.

Cloth, PRICE \$1.00

Radio Instruments and Measurements

A valuable reference book for every day use.

Every instructor and teacher of radio, whether teaching in college or Government training school will find this book a valuable addition to his radio library.

CONTENTS

Part I. Theoretical basis of radio measurements. The fundamentals of electromagnetism. The principles of alternating currents. Radio circuits. Damping.
Part II. Instruments and methods of radio measurement. Wave meters. Condensers. Coils. Current measurement. Resistance measurement. Sources of high-frequency current.
Part III. Formulas and Data. Calculation of capacity. Calculation of inductance. Design of inductance coils. High-frequency resistance. Miscellaneous formulas and data.

In Press—Ready September first

Specialists in
Wireless Literature

WIRELESS PRESS, Inc.

25 Elm Street
NEW YORK, N. Y.

RADIO TELEPHONY

By Alfred N. Goldsmith, Ph. D.

Fellow of the Institute of Radio Engineers
Member of the American Institute of Electrical Engineers
Director of the Radio Telegraphic and Telephonic Laboratory
of the College of the City of New York

This complete text on radio telephony is intended for radio engineers, radio electricians in the Navy, men in the Signal Corps and especially men in the Aviation Service who handle radio equipment. Amateurs and others who desire to be clearly informed concerning this newest and most interesting branch of electric communication will want this book.

It is written in clear style, and presupposes very little knowledge of radio. The text deals largely with the practical aspects of radio telephony and its future. It is copiously illustrated with wiring diagrams and previously unpublished photographs of "wireless telephone" apparatus.

IT IS THE ONLY BOOK TREATING THE SUBJECT OF RADIO
TELEPHONY IN ALL ITS ASPECTS.

Among the unusual features of the book are a description of how radio telephony was carried on over a distance of more than 5,000 miles; an illustrated description of an airplane radio telephone set; an illustrated description of a large ship radiophone set; numerous illustrated sections on smaller ship "wireless telephone" transmitters; land station radio telephone sets of all sizes.

Another noteworthy feature is a description of the method of transmitting a radio telephone message to a ship at sea, or across continent or ocean, including the number of persons involved. This material is in dialogue form and so worded as to require no previous knowledge of the subject.

Among the topics treated are: the construction and operation of the Armstrong oscillating audion circuits; the construction and use of bulb amplifiers; the construction of the great alternators of the Alexanderson and Goldschmidt systems and how they are controlled, especially for radio telephony.

The book is very complete, practically every aspect of radio telephony being covered in detail. There are over 400 separate topics listed in a carefully prepared index.

8vo. 256 pages. 226 illustrations.
Full cloth, stamped in gold. Price \$2.00 net.

Specialists in
Wireless Literature

Wireless Press, Inc.

25 ELM ST.
NEW YORK, N. Y.

MILITARY SIGNAL CORPS MANUAL

By Major J. Andrew White

Chief Signal Officer of the American Guard, Member Institute of
Radio Engineers, Acting President National Wireless Association

This manual, the first of its kind and the only complete work on the broad subject of army signaling, is indispensable to those responding to the call to the colors. Primarily prepared for Signal Corps men, it is a necessity for the proper understanding of apparatus and the tactical employment of troops and equipment.

Officers of infantry and artillery will find the volume of great utility, a proper conception of the enormously enlarged Service of Information being indispensable to all commissioned men.

Its contents include administration and government of military units—tactics of the division on the march, at rest and in engagement—function and operations of the Signal Corps and its relation to the line of the army—drill instruction, mounted and dismounted, for telegraph companies, radio and outpost companies, and battalions of Signal Corps—signaling by telegraph, heliograph, night lantern and flags, radio and service buzzer—camp and field telephones and their uses—radio apparatus of the Signal Corps—scouting, patrolling and tactical employment of field lines.

Prepared with the full co-operation and approval of the Chief Signal Officer, U. S. Army.

CONTENTS

Part I.—Organization

The Signal Corps, An Auxiliary Branch of the Army. The Signal Corps' Relation to the Line of the Army. Aircraft. Government and Administration. Military Courtesy. Personnel. Proficiency Test for Companies of Signal Troops.

Part II.—Drill Instruction

General Principles. Definitions. Commands and Signals. School of the Soldier. Physical Training. School of the Squad. Instruction with Arms. The Company Dismounted. The Soldier Mounted. Elementary Collective Instruction Mounted. Field Signal Troops. The Wire Company. The Radio Company. The Outpost Company. The Field Battalion. Telegraph Signal Troops. The Telegraph Company. The Telegraph Battalion. Base Line Signal Troops. Depot Signal Troops. Ceremonies. Reviews. Inspections. Funeral Escort. The Standard. The Guidon. Manual of the Saber.

Part III.—Technical Instruction and Apparatus

Telegraphy and Telephony. The Voltaic Cell, Ohm's Law, and Primary and Secondary Batteries. The Camp Telephone and the Buzzer. Induction Telegraph Set. Radio-telegraphy. Radio Apparatus of the Signal Corps. Visual Signaling Equipment. Flag Kits. The Heliograph. The Acetylene Lantern. Technical Equipment of Personnel.

Part IV.—Transmission

Transmission of Military Information. General Instructions for Army Signaling. The American Morse Code. The International Morse or General Service Code. Instruction in Garrison. Visual Stations. Telegraphy. Visual Signaling in General. Signaling by Flag, Torch and Lantern, or Beam or Searchlight (without Shutter). Signaling with Heliograph, Flash Lantern, or Searchlight, (with Shutter). The Ardois System. Signaling by Two-Arm Semaphore. Signaling by Hand Flags. General Instructions for Locating and Operating Visual Stations. Letter Codes. Telegraph Code Books and Ciphers. Conventional and Preconcerted Signals with Rockets, Bombs, Small Arms and Guns. Flag Signals by Permanent Hoist. Emergency Signals. Conventional Telephone Signals.

Part V.—Field Service

Signal Troops in the Field. Reconnaissance, Patrolling and Scouting. Military Map Reading. Signal Troops in Field Service. Field Lines. Camps. Company Guard Mounting. The Signal Corps and General Coast Defense. Coast Defense Information in War.

Cloth. 588 pages. 260 illustrations. Price \$1.50 net.

Specialists in
Wireless Literature

Wireless Press, Inc. 25 ELM ST.
NEW YORK, N. Y.



THIS BOOK IS DUE ON THE LAST DATE
STAMPED BELOW

AN INITIAL FINE OF 25 CENTS
WILL BE ASSESSED FOR FAILURE TO RETURN
THIS BOOK ON THE DATE DUE. THE PENALTY
WILL INCREASE TO 50 CENTS ON THE FOURTH
DAY AND TO \$1.00 ON THE SEVENTH DAY
OVERDUE.

JAN 16 1936

LD 21-20m-6,'32

382934

TK5865
B8

Bucher

Engineering
Library
UNIVERSITY OF CALIFORNIA LIBRARY

